

# AIR CONDITIONER

## Wall-Mounted Type

# INSTALLATION MANUAL



PART No. 9387603477-01

For authorized service personnel only.

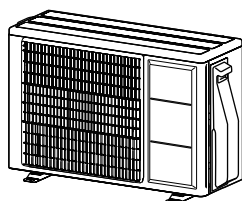

- Hazard alerting symbols



Electrical



Safety/alert

### If Necessary, Get Help

These instructions are all you need for most installation sites and maintenance conditions. If you require help for a special problem, contact our sales/service outlet or your certified dealer for additional instructions.

### In Case of Improper Installation

The manufacturer shall in no way be responsible for improper installation or maintenance service, including failure to follow the instructions in this document.

## 1.2. Special precautions

### When Wiring

ELECTRICAL SHOCK CAN CAUSE SEVERE PERSONAL INJURY OR DEATH. ONLY A QUALIFIED, EXPERIENCED ELECTRICIAN SHOULD ATTEMPT TO WIRE THIS SYSTEM.

- Do not supply power to the unit until all wiring and tubing are completed or reconnected and checked.
- Highly dangerous electrical voltages are used in this system. Carefully refer to the wiring diagram and these instructions when wiring. Improper connections and inadequate grounding (earthing) can cause accidental injury or death.
- Ground (earth) the unit following local electrical codes.
- Connect all wiring tightly. Loose wiring may cause overheating at connection points and a possible fire hazard.

### When Transporting

Be careful when picking up and moving the indoor and outdoor units. Get a partner to help, and bend your knees when lifting to reduce strain on your back. Sharp edges or thin aluminum fins on the air conditioner can cut your fingers.

### When Installing...

#### ...In a Ceiling or Wall

Make sure the ceiling/wall is strong enough to hold the unit's weight. It may be necessary to construct a strong wood or metal frame to provide added support.

#### ...In a Room

Properly insulate any tubing run inside a room to prevent "sweating" that can cause dripping and water damage to walls and floors.

#### ...In Moist or Uneven Locations

Use a raised concrete pad or concrete blocks to provide a solid, level foundation for the outdoor unit. This prevents water damage and abnormal vibration.

#### ...In an Area with High Winds

Securely anchor the outdoor unit down with bolts and a metal frame. Provide a suitable air baffle.

#### ...In a Snowy Area (for Heat Pump-type Systems)

Install the outdoor unit on a raised platform that is higher than drifting snow.

### When Connecting Refrigerant Tubing

- Keep all tubing runs as short as possible.
- Use the flare method for connecting tubing.
- Apply refrigerant lubricant to the matching surfaces of the flare and union tubes before connecting them, then tighten the nut with a torque wrench for a leak-free connection.
- Check carefully for leaks before opening the refrigerant valves.

### When Servicing

- Turn the power OFF at the main circuit breaker panel before opening the unit to check or repair electrical parts and wiring.
- Keep your fingers and clothing away from any moving parts.
- Clean up the site after you finish, remembering to check that no metal scraps or bits of wiring have been left inside the unit being serviced.
- After installation, explain correct operation to the customer, using the operation manual.

## Contents

1. SAFETY PRECAUTIONS.....	1
2. PRODUCT SPECIFICATION.....	5
3. INSTALLATION WORK.....	7
4. ELECTRICAL WIRING.....	10
5. REMOTE CONTROLLER INSTALLATION.....	11
6. FUNCTION SETTING.....	12
7. OPTIONAL KIT INSTALLATION.....	13
8. INSTALLATION WORK.....	13
9. ELECTRICAL WIRING.....	15
10. PIPE INSTALLATION.....	17
11. FINISHING.....	18
12. TEST RUN.....	19
13. CUSTOMER GUIDANCE.....	19
14. ERROR CODES.....	19

Installation must be performed in accordance with the requirement of NEC and CEC by authorized personnel only.

## 1. SAFETY PRECAUTIONS

### 1.1. IMPORTANT! Please read before starting

This air conditioning system meets strict safety and operating standards. As the installer or service person, it is an important part of your job to install or service the system so it operates safely and efficiently.

**For safe installation and trouble-free operation, you must:**

- Carefully read this instruction booklet before beginning.
- Follow each installation or repair step exactly as shown.
- Observe all local, state, and national electrical codes.
- Pay close attention to all warning and caution notices given in this manual.

**WARNING:** This symbol refers to a hazard or unsafe practice which can result in severe personal injury or death.

**CAUTION:** This symbol refers to a hazard or unsafe practice which can result in personal injury and the potential for product or property damage.

English

Français

Español

**⚠ WARNING**

- Installation of this product must be done by experienced service technicians or professional installers only in accordance with this manual. Installation by non-professional or improper installation of the product might cause serious accidents such as injury, water leakage, electric shock, or fire. If the product is installed in disregard of the instructions in this manual, it will void the manufacturer's warranty.
- To avoid getting an electric shock, never touch the electrical components soon after the power supply has been turned off. After turning off the power, always wait 10 minutes or more before you touch the electrical components.
- Do not turn on the power until all work has been completed. Turning on the power before the work is completed can cause serious accidents such as an electric shock or a fire.
- If refrigerant leaks when you are working, ventilate the area. If the leaking refrigerant is exposed to a direct flame, it may produce a toxic gas.
- Installation must be performed in accordance with regulations, codes, or standards for electrical wiring and equipment in each country, region, or the installation place.
- Do not use this equipment with air or any other unspecified refrigerant in the refrigerant lines. Excess pressure can cause a rupture.
- During installation, make sure that the refrigerant pipe is attached firmly before you run the compressor.
- Do not operate the compressor under the condition of refrigerant piping not attached properly with 2-way or 3-way valve open. This may cause abnormal pressure in the refrigeration cycle that leads to rupture and even injury.
- When installing or relocating the air conditioner, do not mix gases other than the specified refrigerant (R32) to enter the refrigerant cycle. If air or other gas enters the refrigerant cycle, the pressure inside the cycle will rise to an abnormally high value and cause rupture, injury, etc.
- For appropriate working of the air conditioner, install it as written in this manual.
- To connect indoor unit and outdoor unit, or indoor unit and branch box, use air conditioner piping and cables available through your local distributor. This manual describes proper connections using such installation set.
- Do not modify power cable, use extension cable or branch wiring. Improper use may cause electric shock or fire by poor connection, insufficient insulation or over current.
- Do not purge the air with refrigerants but use a vacuum pump to vacuum the installation.
- There is not extra refrigerant in the outdoor unit for air purging.
- Use a vacuum pump for R32 or R410A exclusively.
- Using the same vacuum pump for different refrigerants may damage the vacuum pump or the unit.
- Use a clean gauge manifold and charging hose for R32 or R410A exclusively.
- Do not use means to accelerate the defrosting process or to clean, other than those recommended by the manufacturer.
- The appliance shall be stored in a room without continuously operating ignition sources (for example: open flames, an operating gas appliance or an operating electric heater.)
- Do not pierce or burn.
- Be aware that refrigerants may not contain an outdoor.
- Do not modify this unit, such as opening a hole in the cabinet.
- During the pump-down operation, make sure that the compressor is turned off before you remove the refrigerant piping.
- Do not remove the connection pipe while the compressor is in operation with 2 way or 3 way valve open. This may cause abnormal pressure in the refrigeration cycle that leads to rupture and even injury.
- This appliance is not intended for use by persons (including children) with reduced physical, sensory or mental capabilities, or lack of experience and knowledge, unless they have been given supervision or instruction concerning use of the appliance by a person responsible for their safety. Children should be supervised to ensure that they do not play with the appliance.
- Keep any required ventilation openings clear of obstruction.
- If the power cable or the connection cable is damaged, it must be replaced by the manufacturer, its service agent or similar qualified persons in order to avoid a safety hazard.
- To avoid danger of suffocation, keep the plastic bag or thin film used as the packaging material away from young children.
- After servicing, check for refrigerant leak before turning on the unit.
- Cancer and Reproductive Harm - www.P65Warnings.ca.gov.

**⚠ CAUTION**

- For the air conditioner to work appropriately, install it as written in this manual.
  - The appliance shall not be installed in an unventilated space, if that space is smaller than 1.61 m<sup>2</sup>.
  - This product must be installed by qualified personnel with a capacity certification of handling refrigerant fluids. Refer to regulation and laws in use on installation place.
  - Install the product by following local codes and regulations in force at the place of installation, and the instructions provided by the manufacturer.
  - This product is part of a set constituting an air conditioner. The product must not be installed alone or be installed with non-authorized device by the manufacturer.
  - Always use a separate power supply line protected by a circuit breaker operating on all wires with a distance between contact of 1/8 in (3 mm) for this product.
  - To protect the persons, ground (earth) the product correctly, and use the power cable combined with an Earth Leakage Circuit Breaker (ELCB).
  - This product is not explosion proof, and therefore should not be installed in explosive atmosphere.
  - This product contains no user-serviceable parts. Always consult experienced service technicians for repairing.
  - Do not touch the fins of the heat exchanger. Touching the heat exchanger fins could result in damage to the fins or personal injury such as skin rupture.
  - Do not touch the aluminum fins of heat exchanger built-in the indoor or outdoor unit to avoid personal injury when you install or maintain the unit.
  - Do not place any other electrical products or household belongings under the indoor unit. Condensation dripping from the indoor unit might get them wet, and may cause damage or malfunction to the property.
  - When installing pipes shorter than 10 ft (3 m), sound of the outdoor unit may be transferred to the indoor unit, which may cause large operating or abnormal sound.
- Be careful not to scratch the air conditioner when handling it.

**Precautions for using R32 refrigerant**

The basic installation work procedures are the same as conventional refrigerant (R410A, R22) models.

However, pay careful attention to the following points:

**⚠ WARNING**

- Since the working pressure is 1.6 times higher than that of refrigerant R22 models, some of the piping and installation and service tools are special. (Refer to "2.1. Special tools for R32 (R410A)".) Especially, when replacing a refrigerant R22 model with a new refrigerant R32 model, always replace the conventional piping and flare nuts with the R32 and R410A piping and flare nuts on the outdoor unit side. For R32 and R410A, the same flare nut on the outdoor unit side and pipe can be used.
- Models that use refrigerant R32 and R410A have a different charging port thread diameter to prevent erroneous charging with refrigerant R22 and for safety. Therefore, check beforehand. [The charging port thread diameter for R32 and R410A is 1/2-20 UNF.]
- Be more careful than R22 so that foreign matter (oil, water, etc.) does not enter the piping. Also, when storing the piping, securely seal the opening by pinching, taping, etc. (Handling of R32 is similar to R410A.)
- When charging the refrigerant, take into account the slight change in the composition of the gas and liquid phases. And always charge from the liquid phase where refrigerant composition is stable.

This manual includes requirements of clauses according to Table DD.1 (Installation, Maintenance and repair, Decommissioning)

**⚠ WARNING**

- Auxiliary devices which may be a potential ignition source shall not be installed in the duct work. Examples of such potential ignition sources are hot surfaces with a temperature exceeding 1292°F (700°C) and electric switching devices.
- Minimum room area is corrected by multiplying by an altitude adjustment factor (AF) based on for building site ground level altitude ( $H_{alt}$ ) in meters.

**Altitude Adjustment Factor**

$H_{alt}$	0	200	400	600	800	1000	1200	1400	1600
<b>AF</b>	1.00	1.00	1.00	1.00	1.02	1.05	1.07	1.10	1.12
$H_{alt}$	1600	1800	2000	2200	2400	2600	2800	3000	3200
<b>AF</b>	1.12	1.15	1.18	1.21	1.25	1.28	1.32	1.36	1.40

- The appliance shall not be installed in an unventilated space, if that space is smaller than minimum installation area.
- The installation height is the minimum installation height, which is the lowest installation of ductwork outlets or indoor unit, whichever is the lowest, and the minimum installation areas on the table below were determined based on the lowest installation heights 5.9 ft (1.8 m) and 7.2 ft (2.2 m).
- If the ducted air conditioner is used to condition more than one room, then the minimum installation area on table below shall apply to the smallest room.
- Should the desired minimum installation height be below 5.9 ft (1.8 m), the minimum installation area must be re-calculated accordingly.

(UL60335-2-40)

Amount of refrigerant charge M [lbs (kg)]	Minimum room area [ft <sup>2</sup> (m <sup>2</sup> )]	
	Installation height H [ft (m)]	
	5.9 (1.8) ≤ H < 7.2 (2.2)	7.2 (2.2) ≤ H
M ≤ 4.05 (1.836)	—	—
4.05 (1.836) < M ≤ 4.19 (1.90)	74.27 (6.90)	60.82 (5.65)
4.19 (1.90) < M ≤ 4.41 (2.00)	78.25 (7.27)	64.05 (5.95)
4.41 (2.00) < M ≤ 4.63 (2.10)	82.13 (7.63)	67.17 (6.24)
4.63 (2.10) < M ≤ 4.85 (2.20)	86.00 (7.99)	70.40 (6.54)
4.85 (2.20) < M ≤ 5.07 (2.30)	89.99 (8.36)	73.63 (6.84)
5.07 (2.30) < M ≤ 5.29 (2.40)	93.86 (8.72)	76.85 (7.14)
5.29 (2.40) < M ≤ 5.51 (2.50)	97.74 (9.08)	79.98 (7.43)
5.51 (2.50) < M ≤ 5.73 (2.60)	101.72 (9.45)	83.21 (7.73)
5.73 (2.60) < M ≤ 5.95 (2.70)	105.59 (9.81)	86.43 (8.03)
5.95 (2.70) < M ≤ 6.17 (2.80)	109.47 (10.17)	89.56 (8.32)
6.17 (2.80) < M ≤ 6.39 (2.90)	113.45 (10.54)	92.79 (8.62)
6.39 (2.90) < M ≤ 6.61 (3.00)	117.33 (10.90)	96.01 (8.92)
6.61 (3.00) < M ≤ 6.83 (3.10)	121.20 (11.26)	99.14 (9.21)
6.83 (3.10) < M ≤ 7.05 (3.20)	125.08 (11.62)	102.37 (9.51)
7.05 (3.20) < M ≤ 7.28 (3.30)	129.06 (11.99)	105.59 (9.81)
7.28 (3.30) < M ≤ 7.50 (3.40)	132.94 (12.35)	108.82 (10.11)
7.50 (3.40) < M ≤ 7.72 (3.50)	136.81 (12.71)	111.95 (10.40)
7.72 (3.50) < M ≤ 7.94 (3.60)	140.79 (13.08)	115.17 (10.70)
7.94 (3.60) < M ≤ 8.16 (3.70)	144.67 (13.44)	118.40 (11.00)
8.16 (3.70) < M ≤ 8.38 (3.80)	148.54 (13.80)	121.53 (11.29)
8.38 (3.80) < M ≤ 8.60 (3.90)	156.19 (14.51)	124.75 (11.59)
8.60 (3.90) < M ≤ 8.82 (4.00)	164.26 (15.26)	127.98 (11.89)

- Ducts connected to this product shall not contain a potential ignition source such as hot surfaces, flames or current carrying devices that can be the source of arcing or sparking.
- Where the indoor unit is connected via an air duct system to one or more rooms, the supply and return air shall be directly ducted to the space. Open areas such as false ceilings must not be used as a return air duct. And when using auxiliary devices, it shall be installed that is declared suitable with R32 refrigerant in connecting ductwork.

## CAUTION

### 1 General

#### 1-1 Installation

- That pipe work including piping material, pipe routing, and installation shall include protection from physical damage in operation and service, and be in compliance with national and local codes and standards, such as ASHRAE 15, ASHRAE 15.2, IAPMO Uniform Mechanical Code, ICC International Mechanical Code, or CSA B52. All field joints shall be accessible for inspection prior to being covered or enclosed.
- That after completion of field piping for split systems, the field pipework shall be pressure tested with an inert gas and then vacuum tested prior to refrigerant charging, according to the following requirements:  
The minimum test pressure for the low side of the system shall be the low side design pressure and the minimum test pressure for the high side of the system shall be the high side design pressure, unless the high side of the system, cannot be isolated from the low side of the system in which case the entire system shall be pressure tested to the low side design pressure.
- Field-made refrigerant joints indoors shall be tightness tested. The test method shall have a sensitivity of 5 grams per year of refrigerant or better under a pressure of at least 0.25 times the maximum allowable pressure. No leak shall be detected;

#### 1-2 Unventilated areas

- When installing this product to an unventilated area, pay attention to prevent fire and explosion caused by the stagnated gas in case of refrigerant leakage. (For products which contain more than 4.05 lbs (1.836 kg) refrigerant.)
- The appliance shall be stored so as to prevent mechanical damage from occurring.

#### 1-3 Qualification of workers

- As this product uses flammable refrigerant, its installation, repair, maintenance, removal, and deposition must be performed by dedicated service personnel who completed trainings and obtained relevant certificates provided by the domestic training facilities or manufacturers certified for obtaining relevant national certificate stipulated by the applicable law.

### 2 Information on servicing

(Checks to the area)

- Prior to beginning work on systems containing flammable refrigerants, safety checks are necessary to ensure that the risk of ignition is minimized.
- For repair to the refrigerating system, 2-1 to 2-5 shall be completed prior to conducting work on the system.

#### 2-1 Work procedure

- Work shall be undertaken under a controlled procedure so as to minimize the risk of a flammable gas or vapor being present while the work is being performed.

#### 2-2 General work area

- All maintenance staff and others working in the local area shall be instructed on the nature of work being carried out.
- Work in confined spaces shall be avoided.

#### 2-3 Checking for presence of refrigerant

- The area shall be checked with an appropriate refrigerant detector prior to and during work, to ensure the technician is aware of potentially toxic or flammable atmospheres.
- Ensure that the leak detection equipment being used is suitable for use with all applicable refrigerants, i.e. non-sparking, adequately sealed or intrinsically safe.

#### 2-4 Presence of fire extinguisher

- If any hot work is to be conducted on the refrigerating equipment or any associated parts, appropriate fire extinguishing equipment shall be available to hand.
- Have a dry powder or CO<sub>2</sub> fire extinguisher adjacent to the charging area.

#### 2-5 No ignition sources

- No person carrying out work in relation to a refrigerating system which involves exposing any pipe work shall use any sources of ignition in such a manner that it may lead to the risk of fire or explosion.
- All possible ignition sources, including cigarette smoking, should be kept sufficiently far away from the site of installation, repairing, removing and disposal, during which refrigerant can possibly be released to the surrounding space. Prior to work taking place, the area around the equipment is to be surveyed to make sure that there are no flammable hazards or ignition risks. "No Smoking" signs shall be displayed.

#### 2-6 Ventilated area

- Ensure that the area is in the open or that it is adequately ventilated before breaking into the system or conducting any hot work.
- A degree of ventilation shall continue during the period that the work is carried out.
- The ventilation should safely disperse any released refrigerant and preferably expel it externally into the atmosphere.

#### 2-7 Checks to the refrigerating equipment

- Where electrical components are being changed, they shall be fit for the purpose and to the correct specification.
- At all times the manufacturer's maintenance and service guidelines shall be followed. If in doubt, consult the manufacturer's technical department for assistance.
- The following checks shall be applied to installations using flammable refrigerants :
  - the actual refrigerant charge is in accordance with the room size within which the refrigerant containing parts are installed;
  - the ventilation machinery and outlets are operating adequately and are not obstructed;
  - if an indirect refrigerating circuit is being used, the secondary circuit shall be checked for the presence of refrigerant;
  - marking to the equipment continues to be visible and legible. Markings and signs that are illegible shall be corrected;
  - refrigerating pipe or components are installed in a position where they are unlikely to be exposed to any substance which may corrode refrigerant containing components, unless the components are constructed of materials which are inherently resistant to being corroded or are suitably protected against being so corroded.

#### 2-8 Checks to electrical devices

- Repair and maintenance to electrical components shall include initial safety checks and component inspection procedures.
- If a fault exists that could compromise safety, then no electrical supply shall be connected to the circuit until it is satisfactorily dealt with.
- If the fault cannot be corrected immediately but it is necessary to continue operation, an adequate temporary solution shall be used.
- This shall be reported to the owner of the equipment so all parties are advised.
- Initial safety checks shall include:
  - that capacitors are discharged: this shall be done in a safe manner to avoid possibility of sparking;
  - that no live electrical components and wiring are exposed while charging, recovering or purging the system;
  - that there is continuity of earth bonding.

#### 3 Sealed electrical components

Sealed electrical components shall be replaced.

#### 4 Intrinsically safe components

Intrinsically safe components must be replaced.

#### 5 Cabling

- Check that cabling will not be subject to wear, corrosion, excessive pressure, vibration, sharp edges or any other adverse environmental effects.
- The check shall also take into account the effects of aging or continual vibration from sources such as compressors or fans.

#### 6 Detection of flammable refrigerants

- Under no circumstances shall potential sources of ignition be used in the searching for or detection of refrigerant leaks.
- A halide torch (or any other detector using a naked flame) shall not be used.

### 7 Leak detection methods

- The following leak detection methods are deemed acceptable for all refrigerant systems.
- Electronic leak detectors may be used to detect refrigerant leaks but, in the case of flammable refrigerants, the sensitivity may not be adequate, or may need re-calibration. (Detection equipment shall be calibrated in a refrigerant-free area.)
- Ensure that the detector is not a potential source of ignition and is suitable for the refrigerant used.
- Leak detection equipment shall be set at a percentage of the LFL of the refrigerant and shall be calibrated to the refrigerant employed, and the appropriate percentage of gas (25% maximum) is confirmed.
- Leak detection fluids are also suitable for use with most refrigerants but the use of detergents containing chlorine shall be avoided as the chlorine may react with the refrigerant and corrode the copper pipe-work.

#### NOTE:

Examples of leak detection fluids are

- bubble method,
- fluorescent method agents.
- If a leak is suspected, all naked flames shall be removed / extinguished.
- If a leakage of refrigerant is found which requires brazing, all of the refrigerant shall be recovered from the system, or isolated (by means of shut off valves) in a part of the system remote from the leak.

### 8 Removal and evacuation

- When breaking into the refrigerant circuit to make repairs – or for any other purpose – conventional procedures shall be used. However, for flammable refrigerants it is important that best practice is followed since flammability is a consideration. The following procedure shall be adhered to:
  - safely remove refrigerant following local and national regulations;
  - evacuate;
  - purge the circuit with inert gas (optional for R32);
  - evacuate (optional for R32);
  - continuously flush or purge with inert gas when using flame to open circuit; and
  - open the circuit.
- The refrigerant charge shall be recovered into the correct recovery cylinders if venting is not allowed by local and national codes.
- For appliances containing flammable refrigerants, the system shall be purged with oxygen-free nitrogen to render the appliance safe for flammable refrigerants.
- This process might need to be repeated several times.
- Compressed air or oxygen shall not be used for purging refrigerant system (optional for R32).
- For appliances containing flammable refrigerants, refrigerants purging shall be achieved by breaking the vacuum in the system with oxygen-free nitrogen and continuing to fill until the working pressure is achieved, then venting to atmosphere, and finally pulling down to a vacuum (optional for R32).
- This process shall be repeated until no refrigerant is within the system.
- When the final oxygen-free nitrogen charge is used, the system shall be vented down to atmospheric pressure to enable work to take place.
- The outlet for the vacuum pump is not close to any potential ignition sources and that ventilation is available.

### 9 Charging procedures

- In addition to conventional charging procedures, the following requirements shall be followed.
  - Ensure that contamination of different refrigerants does not occur when using charging equipment.
  - Hoses or lines shall be as short as possible to minimize the amount of refrigerant contained in them.
  - Cylinders shall be kept in an appropriate position according to the instructions.
  - Ensure that the refrigerating system is earthed prior to charging the system with refrigerant.
  - Extreme care shall be taken not to overfill the refrigerating system.
- Prior to recharging the system, it shall be pressure tested with the appropriate purging gas.
- The system shall be leak tested on completion of charging but prior to commissioning.
- A follow up leak test shall be carried out prior to leaving the site.

### 10 Decommissioning

- Before carrying out this procedure, it is essential that the technician is completely familiar with the equipment and all its detail.
- It is recommended good practice that all refrigerants are recovered safely.
- Prior to the task being carried out, an oil and refrigerant sample shall be taken in case analysis is required prior to re-use of recovered refrigerant.
- It is essential that electrical power is available before the task is commenced.
  - Become familiar with the equipment and its operation.
  - Isolate system electrically.
  - Before attempting the procedure, ensure that:
    - mechanical handling equipment is available, if required, for handling refrigerant cylinders;
    - all personal protective equipment is available and being used correctly;
    - the recovery process is supervised at all times by a competent person;
    - recovery equipment and cylinders conform to the appropriate standards.
  - Pump down refrigerant system, if possible.
  - If a vacuum is not possible, make a manifold so that refrigerant can be removed from various parts of the system.
  - Make sure that cylinder is situated on the scales before recovery takes place.
  - Start the recovery machine and operate in accordance with instructions.
  - Do not overfill cylinders (no more than 80% volume liquid charge).
  - Do not exceed the maximum working pressure of the cylinder, even temporarily.
  - When the cylinders have been filled correctly and the process completed, make sure that the cylinders and the equipment are removed from site promptly and all isolation valves on the equipment are closed off.
  - Recovered refrigerant shall not be charged into another refrigerating system unless it has been cleaned and checked.





### 11 Labelling

- Equipment shall be labelled stating that it has been decommissioned and emptied of refrigerant.
- The label shall be dated and signed.
- For appliances containing flammable refrigerants, ensure that there are labels on the equipment stating the equipment contains flammable refrigerant.

### 12 Recovery

- When removing refrigerant from a system, either for servicing or decommissioning, it is recommended good practice that all refrigerants are removed safely.
- When transferring refrigerant into cylinders, ensure that only appropriate refrigerant recovery cylinders are employed.
- Ensure that the correct number of cylinders for holding the total system charge is available.
- All cylinders to be used are designated for the recovered refrigerant and labelled for that refrigerant (i.e. special cylinders for the recovery of refrigerant).
- Cylinders shall be complete with pressure-relief valve and associated shut-off valves in good working order.
- Empty recovery cylinders are evacuated and, if possible, cooled before recovery occurs.
- The recovery equipment shall be in good working order with a set of instructions concerning the equipment that is at hand and shall be suitable for the recovery of the flammable refrigerant. If in doubt, the manufacturer should be consulted. In addition, a set of calibrated weighing scales shall be available and in good working order.
- Hoses shall be complete with leak-free disconnect couplings and in good condition.
- The recovered refrigerant shall be returned to the refrigerant supplier in the correct recovery cylinder, and the relevant waste transfer note arranged.
- Do not mix refrigerants in recovery units and especially not in cylinders.
- If compressors or compressor oils are to be removed, ensure that they have been evacuated to an acceptable level to make certain that flammable refrigerant does not remain within the lubricant.
- The compressor body shall not be heated by an open flame or other ignition sources to accelerate this process.
- When oil is drained from a system, it shall be carried out safely.

Explanation of symbols displayed on the indoor unit or outdoor unit.

		<b>WARNING</b>	This symbol shows that this product uses a low burning velocity material. If the refrigerant is leaked and exposed to an external ignition source, there is a risk of fire.
		<b>CAUTION</b>	This symbol shows that the operation manual should be read carefully.
		<b>CAUTION</b>	This symbol shows that a service personnel should be handling this equipment with reference to the installation manual.
		<b>CAUTION</b>	This symbol shows that information is available such as the operation manual or installation manual.

## 2. PRODUCT SPECIFICATION

All products are manufactured to metric units and tolerances. United States customary units are provided for reference only. In cases where exact dimensions and tolerances are required, always refer to metric units.

### 2.1. Special tools for R32 (R410A)

Tool name	Contents of change
Gauge manifold	Pressure is high and cannot be measured with a R22 gauge. To prevent erroneous mixing of other refrigerants, the diameter of each port has been changed. It is recommended the gauge with seals -30 inHg to 768 psi (-0.1 to 5.3 MPa) for high pressure. -30 inHg to 551 psi (-0.1 to 3.8 MPa) for low pressure.
Charge hose	To increase pressure resistance, the hose material and base size were changed. (R32/R410A)
Vacuum pump	A conventional vacuum pump can be used by installing a vacuum pump adapter.
Gas leakage detector	Special gas leakage detector for HFC refrigerant R410A or R32.

### ■ Copper pipes

It is necessary to use seamless copper pipes and it is desirable that the amount of residual oil is less than 0.004 oz/100 ft. (40 mg/10 m). Do not use copper pipes having a collapsed, deformed or discolored portion (especially on the interior surface). Otherwise, the expansion valve or capillary tube may become blocked with contaminants. As an air conditioner using R32 (R410A) incurs pressure higher than when using R22, it is necessary to choose adequate materials.

#### WARNING

- To install a unit that uses R32 refrigerant, use dedicated tools and piping materials that have been manufactured specifically for R32(R410A) use. Because the pressure of R32 refrigerant is approximately 1.6 times higher than R22, failure to use dedicated piping material or improper installation can cause rupture or injury. Furthermore, it can cause serious accidents such as water leakage, electric shock, or fire.
- Do not use the existing (for R22) piping and flare nuts. If the existing materials are used, the pressure inside the refrigerant cycle will rise and cause failure, injury, etc. (Use the special R32/R410A materials.)
- Use (refill or replace with) specified refrigerant (R32) only. Use of unspecified refrigerant can cause product malfunction, burst, or injury.
- Do not mix any gas or impurities except specified refrigerant (R32). Inflow of air or application of unspecified material makes the internal pressure of the refrigerant cycle too high, and may cause product malfunction, burst of piping, or injury.
- For installation purposes, be sure to use the parts supplied by the manufacturer or other prescribed parts. The use of non-prescribed parts can cause serious accidents such as the unit falling, water leakage, electric shock, or fire.
- Do not turn on the power until all work has been completed.
- Do not use a vacuum pump or refrigerant recovery tools with a series motor, since it may ignite. (for outdoor unit)









### 2.2. Accessories

#### WARNING

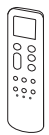

For installation purposes, be sure to use the parts supplied by the manufacturer or other prescribed parts. The use of non-prescribed parts can cause serious accidents such as the unit falling, water leakage, electric shock, or fire.

- The following installation parts are supplied. Use them as required.
- Keep the Installation Manual in a safe place and do not discard any other accessories until the installation work has been completed.

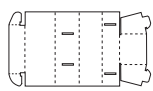
### ■ For indoor unit

Name and Shape	Qty	Name and Shape	Qty
Operation manual 	1	Self-tapping screws (small) 	2
Installation manual (This manual) 	1	Batteries 	2
Remote controller 	1	Wall hook bracket 	1
Remote controller holder 	1	Cloth tape 	1
Self-tapping screws (large) 	5	Installation spacer 	1

### ■ For outdoor unit

Name and shape	Qty	Name and Shape	Qty
Drain pipe 	1	Cable tie 	2
Protection label 	1		

The following items are necessary to install this air conditioner. (The items are not included with the air conditioner and must be purchased separately.)

#### Additional materials

Connection pipe assembly	Wall cap
Connection cable (4-conductor)	Saddle
Wall pipe	Drain hose
Decorative tape	Self-tapping screws
Vinyl tape	Putty

## 2.3. General specification

### 2.3.1. Selecting the pipe material

#### CAUTION

- Do not use existing pipes.
- Use pipes that have clean external and internal sides without any contamination which may cause trouble during use, such as sulfur, oxide, dust, cutting waste, oil, or water.
- It is necessary to use seamless copper pipes. Material: Phosphor deoxidized seamless copper pipes. It is desirable that the amount of residual oil is less than 40 mg/10 m.
- Do not use copper pipes that have a collapsed, deformed, or discolored portion (especially on the interior surface). Otherwise, the expansion valve or capillary tube may become blocked with contaminants.
- Improper pipe selection will degrade performance. As an air conditioner using R32(R410A) incurs pressure higher than when using conventional refrigerant, it is necessary to choose adequate materials.

- Thicknesses of copper pipes used with R32(R410A) are as shown in the table.
- Never use copper pipes thinner than those indicated in the table even if they are available on the market.

#### Thicknesses of Annealed Copper Pipes

Pipe outside diameter [in (mm)]	Thickness [in (mm)]
1/4 (6.35)	0.031 (0.80)
3/8 (9.52)	0.031 (0.80)
1/2 (12.70)	0.031 (0.80)
5/8 (15.88)	0.039 (1.00)
3/4 (19.05)	0.047 (1.20)

### 2.3.2. Protection of pipes

- Protect the pipes to prevent the entry of moisture and dust.
- Especially, pay attention when passing the pipes through a hole or connecting the end of a pipe to the outdoor unit.

Location	Working period	Protection method
Outdoor	1 month or more	Pinch pipes
	Less than 1 month	Pinch or tape pipes
Indoor	-	Pinch or tape pipes

### 2.3.3. Refrigerant pipe size and allowable piping length

#### CAUTION

- Keep the piping length between the indoor unit and outdoor unit within the allowable tolerance.
- The maximum lengths of this product are shown in the table. If the units are further apart than this, correct operation cannot be guaranteed.
- When installing pipes shorter than 10 ft (3 m), sound of the outdoor unit may be transferred to the indoor unit, which will cause large operating sound or some abnormal sound.

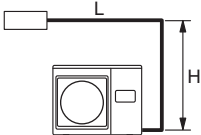
Pipe diameter <Liquid/Gas> [in (mm)]	1/4 (6.35) / 1/2 (12.70)
Max. piping length (L) [ft (m)]	82 (25)
Min. piping length (L) [ft (m)]	10 (3)
Max. height difference (H) <Indoor unit to outdoor unit> [ft (m)]	66 (20)
View (Example)	

#### CAUTION

- Wrap heat insulation around both gas pipe and liquid pipe. No heat-insulation work or incorrect heat-insulation work may cause water leaks.
- In a reverse cycle model, use heat insulation with heat resistance above 248°F (120°C).
- If expected humidity of the installation location of refrigerant pipes is higher than 70%, wrap the heat insulation around the refrigerant pipes. If the expected humidity is between 70% and 80%, use heat insulation that has a thickness of 3/4 in (15 mm) or more. If the expected humidity is higher than 80%, use heat insulation that has a thickness of 13/16 in (20 mm) or more.
- The use of thinner heat insulation than specified above, may cause a condensation on the surface of the insulation.
- Use heat insulation with thermal conductivity of 0.045 W/(m·K) or less, 68°F (20°C).

## 2.4. Electrical requirement

The indoor unit is powered from the outdoor unit. Do not power indoor unit from separate power source.

#### WARNING

- Standard for electrical wiring and equipment differs in each country or region. Before you start electrical working, confirm related regulations, codes, or standards.
- Be sure to install a breaker of the specified capacity (for outdoor unit).

Voltage rating	208/230 V~60 Hz
Operating range	187 to 253 V

Cable	Cable type	Remarks
Power Supply Cable	14AWG	2 cable + Ground (Earth)
Connection Cable	14AWG	3 cable + Ground (Earth)

\*1 Selected sample: Select the correct cable type and size according to the country or region's regulations.

- Limit the voltage drop less than 2%. Increase the cable diameter if voltage drop is 2% or more.

#### CAUTION

Outdoor unit capacity	MINIMUM CIRCUIT AMPACITY	MAX. CKT. BKR.
24	17.8 A	20 A

- Select the breaker that enough load current can pass through it.
- Before starting work check that power is not being supplied to all poles of the indoor unit and outdoor unit.
- Install all electrical works in accordance to relevant national regulations.
- Install the disconnect device with a contact gap of at least 1/8 in (3 mm) in all poles nearby the units. (Both indoor unit and outdoor unit)
- Install the circuit breaker nearby the units.

## 2.5. Optional parts

Refer to each installation manual for the method of installing optional parts.

Parts name	Model No.	Application
WLAN adapter	UTY-TFSXH4	For wireless LAN control

- Optional parts are subject to change without notice.

## 2.6. Additional charge

#### CAUTION

When adding refrigerant, add the refrigerant from the charging port at the completion of work.

#### For Label (Refrigerant charge)

(1) Fill the following information with the immortal ink in the refrigerant label attached to the outdoor unit.

1. Factory charge (① : Refer to rating label)
2. Additional charge (② : Additional filling volume when installed)
3. Total charge (①+②)

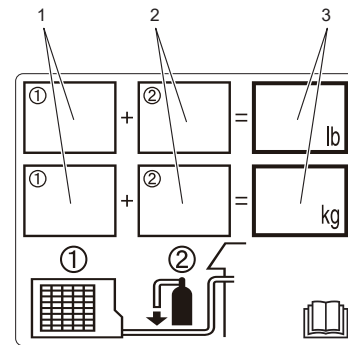

Label (Refrigerant charge)

(2) After fill in the refrigerant label, attach a contained protection label on the filled part to preserve information.

#### If additional refrigerant is required

Refrigerant suitable for a piping length of 49 ft (15 m) is charged in the outdoor unit at the factory.

When the piping is longer than 49 ft (15 m), additional charging is necessary.

For the additional amount, refer to the following table.

Pipe length	49 ft (15 m)	66 ft (20 m)	82 ft (25 m)	Rate
Additional refrigerant	None	+3.5 oz (+100 g)	+7.0 oz (+200 g)	0.2 oz/ft (20 g/m)

Model	Maximum amount of refrigerant charge
24	49.37 oz (42.32 oz + 7.05 oz) [1400 g (1200 g + 200 g)]

## 2.7. Operable conditions of temperature

	Cooling mode Dry mode	Heating mode [Reverse cycle model only]
Outdoor temperature	50 to 122°F * ( 10 to 50°C * )	5 to 75°F ( -15 to 24°C )

- If this unit is operated outside the operating temperature, the protection circuits may be activated to stop the unit.

\* Suction temperature of the outdoor unit.

### 3. INSTALLATION WORK

[For indoor unit]

#### 3.1. Selecting the mounting position

Decide the mounting position with the customer as follows:

- (1) Install the indoor unit level on a strong wall which is not subject to vibration.
- (2) The inlet and outlet ports should not be obstructed: the air should be able to blow all over the room.
- (3) Install the unit a dedicated electrical branch circuit.
- (4) Do not install the unit where it will be exposed to direct sunlight.
- (5) Install the unit where connection to the outdoor unit is easy.
- (6) Install the unit where the drain pipe can be easily installed.
- (7) Take servicing, etc. into consideration and leave the spaces shown in "3.2. Installation dimensions". Also install the unit where the filter can be removed.

Correct initial installation location is important because it is difficult to move the unit after it is installed.

#### ⚠ WARNING

Install the air conditioner in a location which can withstand a load of at least 3 times the weight of the main unit and which will not amplify sound or vibration. If the installation location is not strong enough, the indoor unit may fall and cause injuries.

Withstandable weight (Unit weight x 3\*)

86 lbs (39 kg)

\*In accordance with UL standards.

#### ⚠ CAUTION

- Do not install the unit in the following areas:
  - Area with high salt content, such as at the seaside. It will deteriorate metal parts, causing the parts to fail or the unit to leak water.
  - Area filled with mineral oil or containing a large amount of splashed oil or steam, such as a kitchen. It will deteriorate plastic parts, causing the parts to fail or the unit to leak water.
  - Area that generates substances that adversely affect the equipment, such as sulfuric gas, chlorine gas, acid, or alkali. It will cause the copper pipes and brazed joints to corrode, which can cause refrigerant leakage.
  - Area that can cause combustible gas to leak, contains suspended carbon fibers or flammable dust, or volatile inflammables such as paint thinner or gasoline. If gas leaks and settles around the unit, it can cause a fire.
  - Area where animals may urinate on the unit or ammonia may be generated.
- Do not use the unit for special purposes, such as storing food, raising animals, growing plants, or preserving precision devices or art objects. It can degrade the quality of the preserved or stored objects.
- Do not install where there is the warning of combustible gas leakage.
- Do not install the unit near a source of heat, steam, or flammable gas.
- Install the unit where drainage does not cause any trouble.
- Install the indoor unit, outdoor unit, branch box, power supply cable, connection cable, and remote controller cable at least 40 in (1m) away from a television or radio receivers. The purpose of this is to prevent TV reception interference or radio noise. (Even if they are installed more than 40 in (1m) apart, you could still receive noise under some signal conditions.)
- If children under 10 years old may approach the unit, take preventive measures so that they cannot reach the unit.

#### 3.2. Installation dimensions

#### ⚠ WARNING

During transportation or relocation of the indoor unit, pipes shall be covered with the wall hook bracket for protection. Do not move the appliance by holding the indoor unit pipes. (The stress applied to the pipe joints may cause the flammable gas to leak during operation.)

Keep the distance between the wall hook bracket or indoor unit to the surrounding walls as indicated in the following figure.

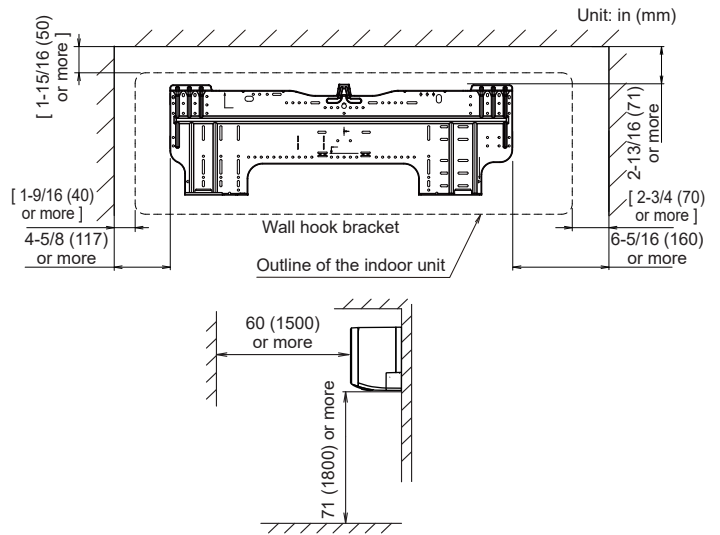

#### 3.3. Removing and replacing parts

##### 3.3.1 Intake grille removal and installation

###### ■ Intake grille removal

- (1) Hold the intake grille with both hands at the side, then pull to the front until it becomes hooked.
- (2) Keeping the intake grille in a horizontal position, pull the mounting shaft on the left and right to release.

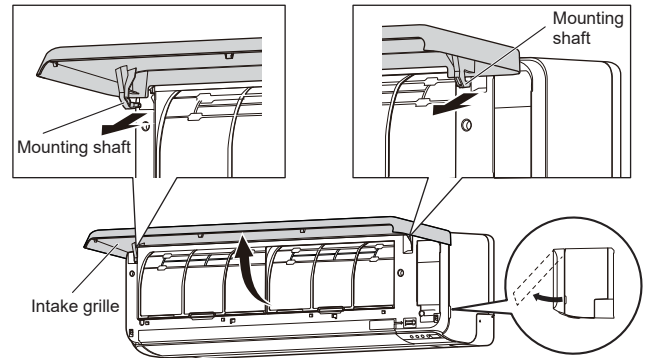

###### ■ Intake grille installation

- (1) Attach the left and right mounting shaft in the direction of the arrow to the panel top bearing while supporting the intake grille horizontally. Press this until it clicks so that each shaft snaps into place.

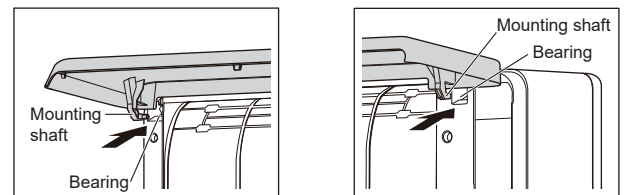

- (2) Press and close the intake grille.

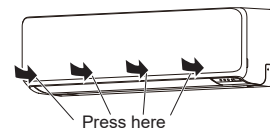

### 3.2.2. Wire cover / front panel / control cover removal and installation

• In this description, the intake grille already has been removed.

#### ■ Wire cover / front panel / control cover / under cover (L/R/C) removal

- (1) Remove the self-tapping screw for the wire cover.
- (2) Remove the under cover L/R. Press down on the markings on the side, then slide down.  
(If needed, remove the piping groove and make a necessary adjustment.)
- (3) Remove under cover C.  
**NOTE:** When removing the screw covers, protect the peripheral parts using soft cloth, etc. to avoid the parts being damaged by the tool.
  - Remove the screw covers (2 places).
  - Remove the screws (2 places).
  - Pull down the center of the under cover C and remove it.  
If needed, remove the piping bracket (2 places).
- (4) Remove the screw covers (2 places) on the bottom of the front panel, and then remove the screws (4 places).
- (5) Push down on the markings (2 places) on top of the front panel to release the hooks (3 places), then pull the front panel towards you.
- (6) Pinch the tab on the control cover to release the hook, then open.

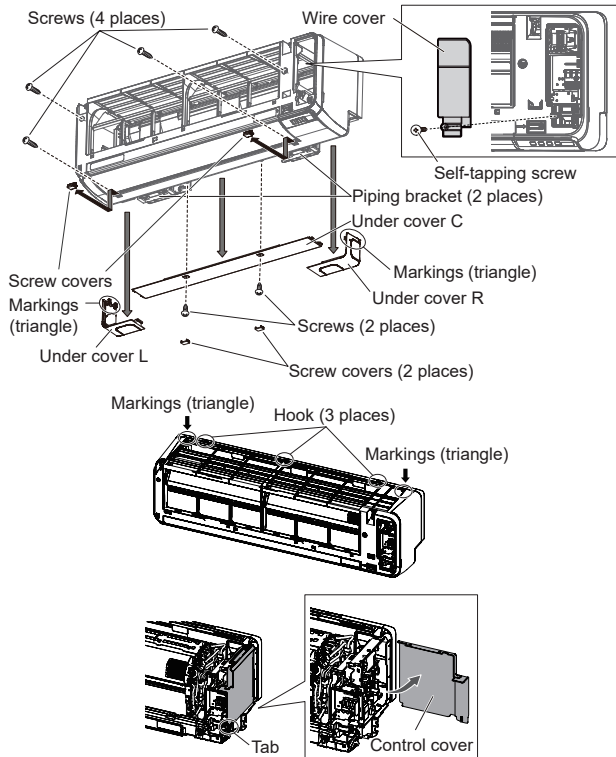

#### ■ Wire cover / front panel / control cover / under cover (L/R/C) installation

Install the previous figure in reverse order.

\* Be sure to attach the screws (4 places), screw cover (2 places) for front panel and screws (2 places), screw covers (2 places) for under cover C.

#### ⚠ CAUTION

Take caution when removing or installing the front panel. If the front panel falls, there is a risk of injury.

### 3.3.3. Uninstalling the indoor unit

Remove the indoor unit from the wall hook bracket as follows.

- (1) Put your fingers in the outer opening of the piping holder (A) in the figure. While pushing down the piping holder (A), remove the hook from the wall hook bracket (2 places).
- (2) Pull the indoor unit towards you.

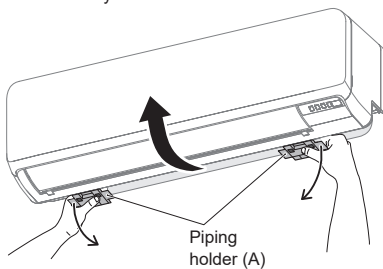

### 3.4. Indoor unit piping direction

The piping can be connected in the 6 directions indicated in the following. When the piping is connected to direction (B), (C), (D), or (E), cut along the piping groove on the side of the front panel with a hacksaw.

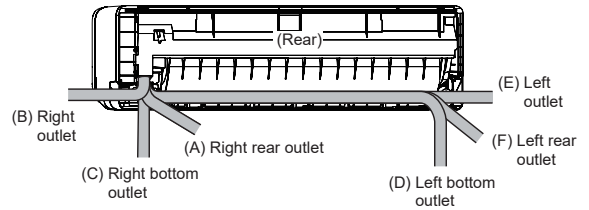

Example: In the case of Right outlet (Although the figure in the case of Left outlet is omitted, the same shall apply.)

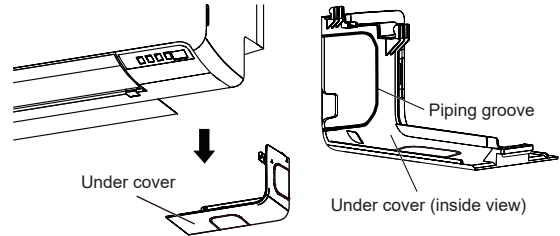

### 3.5. Cutting the hole in the wall for connecting the pipes

- (1) Cut a 3-1/8 in (80 mm) diameter hole in the wall at the position shown in the following.
- (2) Cut the hole so that the outside end is lower (3/16 to 3/8 in [5 to 10 mm]) than the inside end.
- (3) Always align the center of the wall hole. If misaligned, water leakage will occur.
- (4) Cut the wall pipe to match the wall thickness, stick it into the wall cap, fasten the cap with vinyl tape, and stick the pipe through the hole.
- (5) For the left piping and the right piping, cut the hole a little lower so that drain water will flow freely.

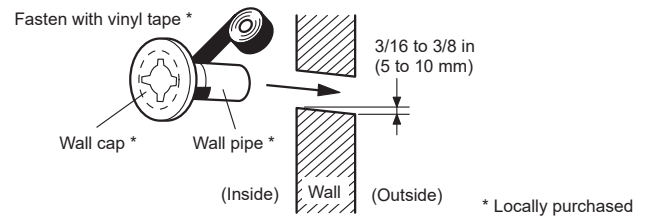
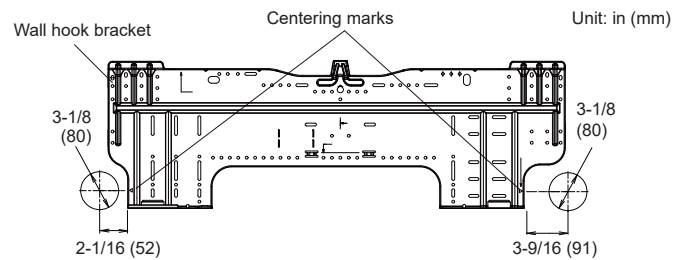

#### ⚠ WARNING

Always use the wall pipe. If the wall pipe is not used, the cable that is connected between the indoor unit and the outdoor unit may touch metal, and cause an electric discharge.

### 3.6. Installing the wall hook bracket

- (1) Install the wall hook bracket so that it is correctly positioned horizontally and vertically. If the wall hook bracket is tilted, water will drip to the floor.
- (2) Install the wall hook bracket so that it is strong enough to support the weight of the unit.
  - Fasten the wall hook bracket to the wall with 5 or more screws through the holes near the outer edge of the bracket.
  - Check that there is no rattle at the wall hook bracket.

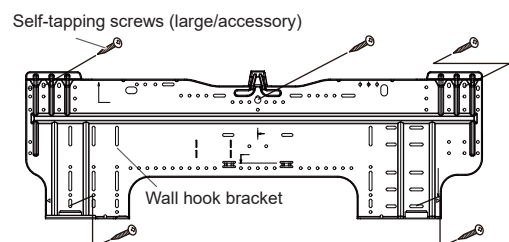

**CAUTION**

Install the wall-hook bracket both horizontally and vertically aligned. Misaligned installation may cause water leakage.

**CAUTION**

Insert the drain hose and drain cap into the drain port, making sure that it comes in contact with the back of the drain port, and then mount it. If the drain hose is not connected properly, leaking will occur.

**3.7. Forming the drain hose and pipe**

**CAUTION**

- Insert drain hose and drain cap securely. Drain should slope down to avoid water leakage.
- When inserting the drain hose, no other material than water should be applied. Application of other material than water will cause deterioration of the hose, and may cause water leakage.
- After you remove a drain hose, be sure to attach the drain cap.
- When you secure the piping and drain hose with tape, arrange the drain hose so that it is at the bottom of the piping.
- For drain hose piping in low temperature environment, you need to apply freeze protection to prevent a frozen drain hose. After cooling operation is performed in low temperature environment (when outdoor temperature under 32°F (0°C), water in the drain hose could be frozen. Frozen drain water will block the water flow in the hose, and may cause water leakage at the indoor unit.

**■ For Right rear piping, Right piping, Right bottom piping**

- Install the indoor unit piping in the direction of the wall hole and bind the drain hose and pipe together with vinyl tape.
- Install the piping so that the drain hose is at the bottom.
- Wrap the pipes of the indoor unit that are visible from the outside with decorative tape.

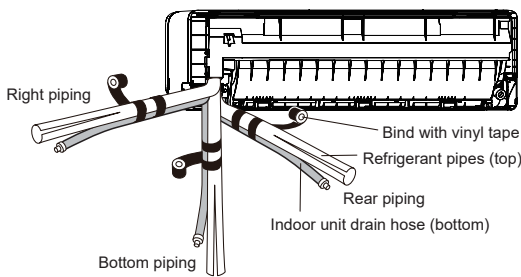

**■ For Left rear piping (Drain hose), Left piping (Drain hose), Left bottom piping (Drain hose)**

Interchange the drain cap and the drain hose.

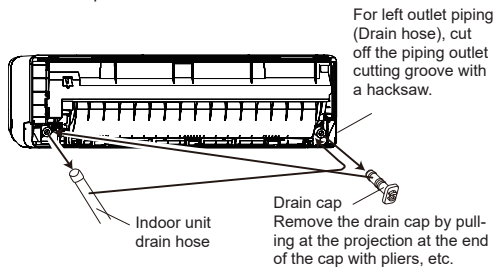

**Removing the drain hose**

Remove the screw at the left of drain hose and pull out drain hose.

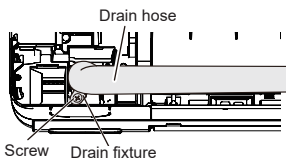

**Installing the drain hose**

Vertically insert the drain hose toward the inside, so that the drain fixture (white) can accurately align with the screw hole around the drain cock. After inserting and before replacing, please reinstall and fix the removed screws.

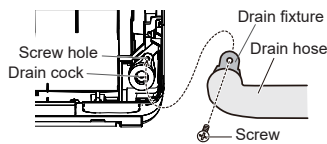

- Please hold around the joint of the drain hose during work.
- As the screw is inside, be sure to use screwdrivers treated with magnet.

**Installing the drain cap**

Use a hexagonal wrench 4 mm at opposite side to insert the drain cap, till the drain cap contacts the tip of the drain cock.

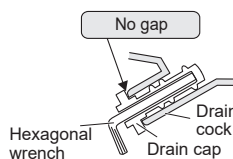

- After passing the indoor piping and drain hose through the wall hole, hang the indoor unit on the hooks at the top and bottom of the wall hook bracket.

**[Installing the indoor unit]**

- Hang the indoor unit from the hooks at the top of the wall hook bracket.
- Insert the spacer, etc. within the area(gray insulation) between the indoor unit and the wall hook bracket and separate the bottom of the indoor unit from the wall.

Unit: in (mm)

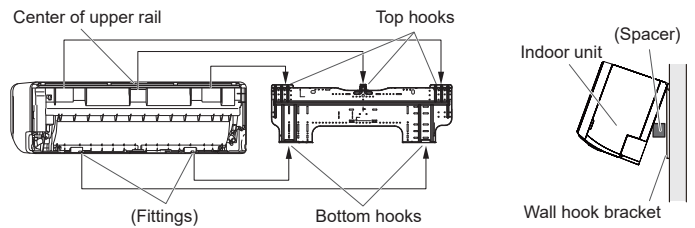
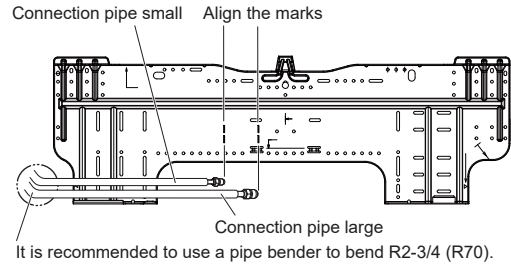

- After hooking the indoor unit to the top hook, hook the fittings of the indoor unit to the bottom hooks while lowering the unit and pushing it against the wall.

**3.8. Pipe connection**

**CAUTION**

Tighten the flare nuts with a torque wrench using the specified tightening method. Otherwise, the flare nuts could break after a prolonged period, causing refrigerant to leak and generate hazardous gas if the refrigerant comes into contact with a flame.

**3.8.1. Flaring**

Use special pipe cutter and flare tool designed for R410A or R32 pipework.

- (1) Cut the connection pipe to the necessary length with a pipe cutter.
- (2) Hold the pipe downward so that cuttings will not enter the pipe and remove any burrs.
- (3) Insert the flare nut (always use the flare nut attached to the indoor unit(s) and outdoor unit or branch box respectively) onto the pipe and perform the flare processing with a flare tool. Use the special R410A or R32 flare tool, or the conventional flare tool. Leakage of refrigerant may result if other flare nuts are used.
- (4) Protect the pipes by pinching them or with tape to prevent dust, dirt, or water from entering the pipes.

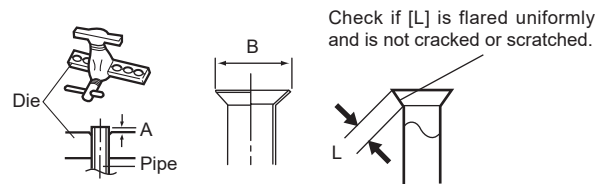

Pipe outside diameter [in (mm)]	Dimensions A [in (mm)]	Dimensions B [in (mm)]
	Flare tool for R32, clutch type	
1/4 (6.35)	0 to 0.020 (0 to 0.5)	3/8 (9.1)
3/8 (9.52)		1/2 (13.2)
1/2 (12.70)		5/8 (16.6)
5/8 (15.88)		3/4 (19.7)
3/4 (19.05)		15/16 (24.0)

When using conventional flare tools to flare R32 pipes, the dimensions A should be approximately 0.020 in (0.5 mm) more than indicated in the table (for flaring with R32 flare tools) to achieve the specified flaring. Use a thickness gauge to measure the dimensions A.

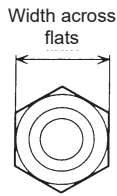

Pipe outside diameter [in (mm)]	Width across flats of Flare nut [in (mm)]
1/4 (6.35)	11/16 (17)
3/8 (9.52)	7/8 (22)
1/2 (12.70)	1 (26)
5/8 (15.88)	1-1/8 (29)
3/4 (19.05)	1-7/16 (36)

**NOTE:** The flare nut specification is compliant with ISO14903.

### 3.8.2. Bending pipes

#### CAUTION

- To prevent breaking of the pipe, avoid sharp bends.
- If the pipe is bent repeatedly at the same place, it will break.

- The pipes are shaped by your hands. Be careful not to collapse them.
- Bend R2-3/4 in (R70 mm) or more with a pipe bender.
- Do not bend the pipes in an angle more than 90°.
- When pipes are repeatedly bend or stretched, the material will harden, making it difficult to bend or stretch them anymore.
- Do not bend or stretch the pipes more than 3 times.
- When bending the pipe, do not bend it as is. The pipe will be collapsed. In this case, cut the insulating pipe with a sharp cutter as shown on the right, and bend it after exposing the pipe. After bending the pipe as you want, be sure to put the heat insulating pipe back on the pipe, and secure it with tape.

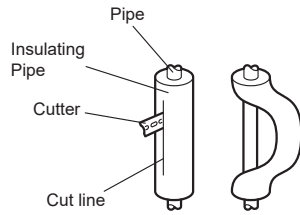

### 3.8.3. Flare connection

#### CAUTION

- Be sure to install the pipe against the port on the indoor unit correctly. If the centering is improper, the flare nut cannot be tightened smoothly. If the flare nut is forced to turn, the threads will be damaged.
- Do not remove the flare nut from the indoor unit pipe until immediately before connecting the connection pipe.
- Hold the torque wrench at its grip, keeping it in the right angle with the pipe, in order to tighten the flare nut correctly.
- Tighten the flare nuts with a torque wrench using the specified tightening method. Otherwise, the flare nuts could break after a prolonged period, causing refrigerant to leak and generate hazardous gas if the refrigerant comes into contact with a flame.
- Connect the piping so that the control box cover can easily be removed for servicing when necessary.
- In order to prevent water from leaking into the control box, make sure that the piping is well insulated.

When the flare nut is tightened properly by your hand, hold the body side coupling with a wrench, then tighten with a torque wrench. (See the following table for the flare nut tightening torques.)

Tighten with 2 wrenches.

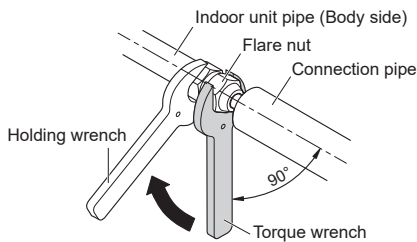

Flare nut [in (mm)]	Tightening torque [lb-ft (N·m)]
1/4 (6.35) dia.	11.8 to 13.3 (16 to 18)
3/8 (9.52) dia.	23.6 to 31.0 (32 to 42)
1/2 (12.70) dia.	36.1 to 45.0 (49 to 61)
5/8 (15.88) dia.	46.5 to 55.3 (63 to 75)
3/4 (19.05) dia.	66.4 to 81.1 (90 to 110)

Do not remove the cap from the connection pipe before connecting the pipe.

## 4. ELECTRICAL WIRING

[For indoor unit]

#### WARNING

- Before connecting the wires, make sure the power supply is OFF.
- Every wire must be connected firmly.
- No wire should be allowed to touch refrigerant tubing, the compressor, or any moving part.
- Loose wiring may cause the terminal to overheat or result in unit malfunction. A fire hazard may also exist. Therefore, be sure all wiring is tightly connected.
- Connect wires to the matching numbers of terminals.

#### CAUTION

Be careful not to generate a spark as follows for using a flammable refrigerant.

- Do not remove the fuse while the power is on.
- Do not disconnect the wiring while the power is on.
- It is recommended to position the outlet connection in a high position. Place the cords so that they do not get tangled.

### 4.1. Wiring system diagram

#### 4.1.1. Wiring system diagram

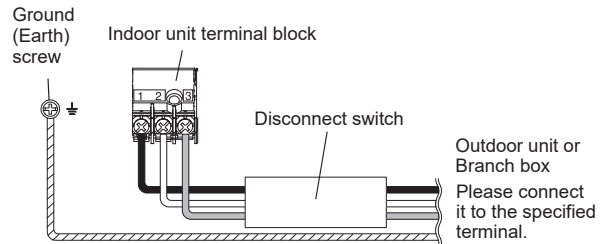
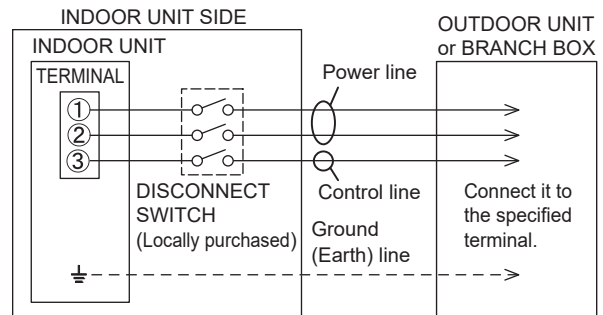

- To connect the indoor unit wires to the terminal correctly, refer to the figure for proper length.

Unit: in (mm)

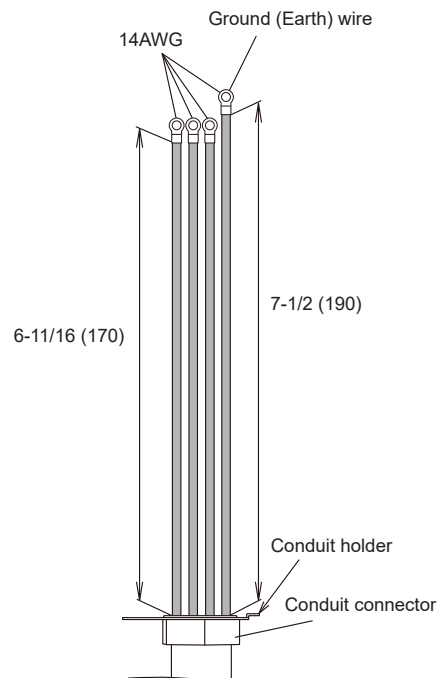

#### 4.1.2. How to install the connection cable

- (1) Remove the screws, then remove the conduit holder.
- (2) Fasten the indoor unit wire harness to the conduit holder using the lock nut.  
**IMPORTANT:** Refer to "4.1.1. Wiring system diagram" about the length of indoor unit wire harness.
- (3) Use the screws to install the conduit holder provide with the indoor unit.
- (4) Remove the screws, then remove the cable clumper.
- (5) Connect indoor unit wire harness to the terminal.  
Refer to "4.1.1. Wiring system diagram".
- (6) Use the screws to install the cable clumper.

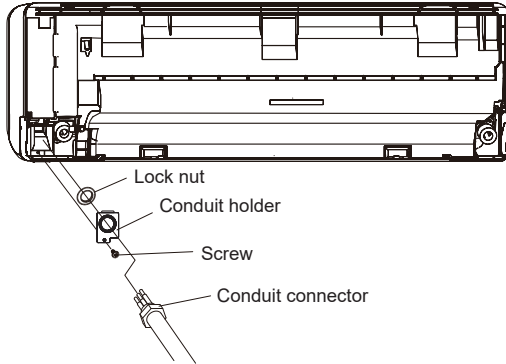

### 4.2. Indoor unit wiring

- (1) Remove the intake grille. (Refer to "3.3.1 Intake grille removal and installation".)
- (2) Remove the screw for the wire cover.

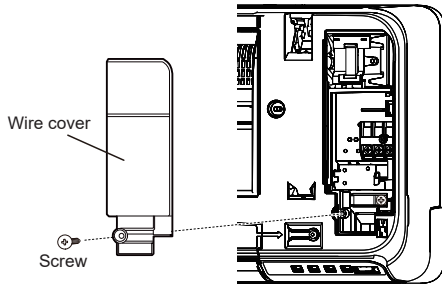

- (3) Remove the screw and while minding the cable clamp hook, remove the cable clamp.

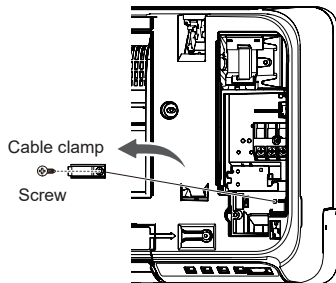

### 4.3. How to connect wiring to the terminals

#### ■ Caution when wiring cable

##### Caution when wiring cable

When stripping off the insulation of a lead wire, always use a special tool such as a wire stripper. If there is no special tool available, carefully strip the insulation with a knife etc.

- (1) Use ring terminals with insulating sleeves as shown in the following figure to connect to the terminal block.
- (2) Securely clamp the ring terminals to the wires using an appropriate tool so that the wires do not come loose.

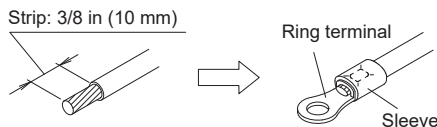

- (3) Use the specified wires, connect them securely, and fasten them so that there is no stress placed on the terminals.
- (4) Use an appropriate screwdriver to tighten the terminal screws. Do not use a screwdriver that is too small, otherwise, the screw heads may be damaged and prevent the screws from being properly tightened.

- (5) Do not tighten the terminal screws too much, otherwise, the screws may break.

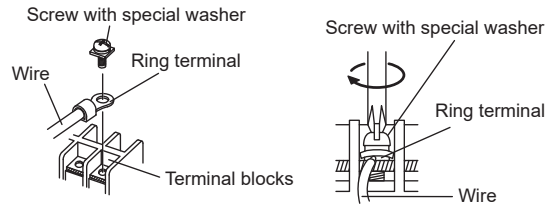

- (6) Refer to the following table for the terminal screw tightening torques.

Tightening torque [lbf-in (N·m)]	
M3.5 screw	7.0 to 8.8 (0.8 to 1.0)
M4 screw	10.6 to 15.9 (1.2 to 1.8)
M5 screw	17.7 to 26.5 (2.0 to 3.0)

#### ⚠ CAUTION

- Attach the cable clamp firmly by holding the connection cable, and make sure that the clamp is fixed securely. Incomplete attachment of the cable clamp might cause a malfunction of the open panel.
- Match the terminal block numbers and connection cable colors with those of the outdoor unit or branch box. Erroneous wiring may cause burning of the electric parts.
- Connect the connection cables firmly to the terminal block. Imperfect installation may cause a fire.
- Always fasten the outside covering of the connection cable with the cable clamp. (If the insulator is chafed, electric discharge may occur.)
- Always connect the ground (earth) wire.
- Do not use the ground (earth) screw of the indoor unit for the connection other than a specified outdoor unit.

- (7) Fix the conduit with the supporters as shown below.

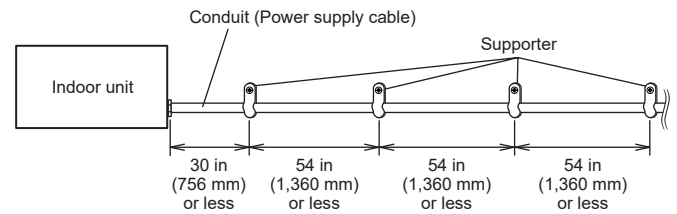

## 5. REMOTE CONTROLLER INSTALLATION

[For indoor unit]

Check that the indoor unit correctly receives the signal from the remote controller, then install the remote controller holder.

#### ⚠ CAUTION

Do not install the remote controller holder in the following conditions:

- Any places exposed in direct sunlight
- Positions affected by the heat from a stove or heater

### 5.1. Remote controller holder installation

- Install the remote controller a maximum distance of 22 ft (7 m) from the remote control signal receiver. After installing the remote controller, check that it operates correctly.
- Install the remote controller holder to a wall, pillar, etc. with the Self-tapping screw.
- For battery installation, refer to the operation manual.

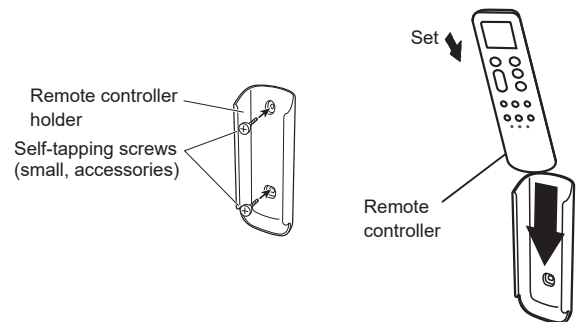

## 5.2. Remote controller custom setting

### ■ Custom code setting

By setting custom code of indoor unit and remote controller, you can specify the air conditioner which the remote controller controls.

When two or more air conditioners are in the room and you wish to operate them separately, set the custom code (4 selections possible).

**NOTES:** If custom codes is different between the indoor unit and the remote controller, the indoor unit cannot receive a signal from the remote controller.

#### How to set the remote controller custom code

- Press  $\text{ON/OFF}$  until the indicators on the remote controller turn off.
- Press down [MODE] for more than 5 seconds.

The current custom code will be displayed (initially set to  $\text{A}$ ).

- Press [TEMP./SELECT ( $\text{A}$   $\text{V}$ )] to change the custom code between A ( $\text{A}$ )  $\leftrightarrow$  B ( $\text{b}$ )  $\leftrightarrow$  C ( $\text{c/l}$ )  $\leftrightarrow$  D ( $\text{d}$ ).

\* Match the custom code on the display to the air conditioner custom code.

- Press [MODE] again.  
The custom code will be set.  
The display will return to the original display.

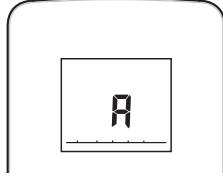

- To change the air conditioner custom code, contact an authorized service personnel (initially set to  $\text{A}$ ).
- If you do not press any buttons for 30 seconds after the custom code is displayed, the display returns to the original display. In this case, repeat the setting from step 2.
- Depending on the remote controller, the custom code may return to  $\text{A}$  when replacing the batteries. In this case, reset the custom code as necessary. If you do not know the air conditioner custom code, try each code until you find the code which operates the air conditioner.

## 6. FUNCTION SETTING

[For indoor unit]

Perform the Function Setting according to the installation conditions using the remote controller.

### ⚠ CAUTION

- Confirm whether the wiring work for outdoor unit has been finished.
- Confirm that the cover for the electrical enclosure on the outdoor unit is in place.

- This procedure changes to the function settings used to control the indoor unit according to the installation conditions. Incorrect settings can cause the indoor unit to malfunction.
- If the air conditioner is operating, press [ $\text{ON/OFF}$ ] to stop the operation. Perform the function setting according to the installation conditions using the remote controller.
- The settings may be selected between the following two: Function number or Setting value.
- Settings will not be changed if invalid numbers or setting values are selected.

### ■ Remote controller setting

#### Entering the function setting mode

While pressing [FAN] and [TEMP./SELECT ( $\text{A}$   $\text{V}$ )] simultaneously, press [RESET] to enter the function setting mode.

#### STEP 1

#### Setting the remote controller custom code

Use the following steps to select the custom code of the remote controller. (Note that the air conditioner cannot receive a custom code if the air conditioner has not been set for the custom code.) The custom code that is set through this process are applicable only to the custom in the function setting.

- Press [TEMP./SELECT ( $\text{A}$   $\text{V}$ )] to change the custom code between A ( $\text{A}$ )  $\leftrightarrow$  B ( $\text{b}$ )  $\leftrightarrow$  C ( $\text{c/l}$ )  $\leftrightarrow$  D ( $\text{d}$ ). Match the code on the display to the air conditioner custom code. (initially set to  $\text{A}$ ) (If the custom code does not need to be selected, press [MODE] and proceed to STEP 2.)

- Press [MODE] to accept the custom code, and proceed to STEP 2

The air conditioner custom code is set to  $\text{A}$  prior to shipment.  
Contact your retailer to change the custom code.

The remote controller resets to custom code  $\text{A}$  when the batteries in the remote controller are replaced. If you use a custom code other than custom code  $\text{A}$ , reset the custom code after replacing the batteries.  
If you do not know the air conditioner custom code setting, try each of the custom codes (A ( $\text{A}$ )  $\leftrightarrow$  B ( $\text{b}$ )  $\leftrightarrow$  C ( $\text{c/l}$ )  $\leftrightarrow$  D ( $\text{d}$ )) until you find the code which operates the air conditioner.

#### STEP 2

#### Setting the function number and setting value

- Press [TEMP./SELECT ( $\text{A}$   $\text{V}$ )] to select the function number.  
(Press [MODE] to switch between the left and right digits.)
- Press [FAN] to proceed to setting the value.  
(Press [FAN] again to return to the function number selection.)
- Press [TEMP./SELECT ( $\text{A}$   $\text{V}$ )] to select the setting value.  
(Press [MODE] to switch between the left and right digits.)
- Press [TIMER], then after you hear the beep emitted from the indoor unit, press [ $\text{ON/OFF}$ ] to confirm the settings.
- Press [RESET] to cancel the function setting mode.
- After completing the function setting, be sure to disconnect the power supply and then reconnect it.

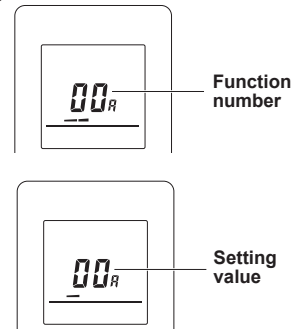

### ⚠ CAUTION

After disconnecting the power supply, wait 30 seconds or more before reconnecting it. The function setting will not become active unless the power supply is disconnected and then reconnected.

## 6.1. Function Details

### ■ Filter sign

Select appropriate intervals for displaying the filter sign on the indoor unit according to the estimated amount of dust in the air of the room.

If the indication is not required, select "No indication" (03).

(♦... Factory setting)

Function number	Setting value	Setting description
11	00	Standard (400 hours)
	01	Long interval (1000 hours)
	02	Short interval (200 hours)
	03	No indication

### ■ Auto restart

Enable or disable automatic restart after a power interruption.

(♦... Factory setting)

Function number	Setting value	Setting description
40	00	Enable
	01	Disable

\* Auto restart is an emergency function such as for power outage etc. Do not attempt to use this function in normal operation. Be sure to operate the unit by remote controller or external device.

### ■ Remote controller custom code

(Only for wireless remote controller)

The indoor unit custom code can be changed. Select the appropriate custom code.

(♦... Factory setting)

Function number	Setting value	Setting description
44	00	A
	01	B
	02	C
	03	D

### ■ Indoor unit fan control for energy saving for cooling

Enables or disables the power-saving function by controlling the indoor unit fan rotation when the outdoor unit is stopped during cooling operation.

(♦... Factory setting)

Function number	Setting value	Setting description
49	00	Disable
	01	Enable
	02	Remote controller

00: When the outdoor unit is stopped, the indoor unit fan operates continuously following the setting on the remote controller.

01: When the outdoor unit is stopped, the indoor unit fan operates intermittently at a very low speed.

02: Enable or disable this function by remote controller setting.

## ■ Setting record

Record any changes to the settings in the following table.

Function number	Setting description	Setting value
11	Filter sign	
40	Auto restart	
44	Remote controller custom code	
49	Indoor unit fan control for energy saving for cooling	

After completing the Function Setting, be sure to disconnect the power supply and then reconnect it.

## 6.2. Temperature correction

### NOTES:

When changing Function 95, perform this setting before other Room temp. control settings (Function 30, 31).

If Function 95 is not set first, Room temperature control settings (Function 30, 31) will be reset and you must re-do them again.

### ■ Heat Insulation condition (building insulation)

Heat insulation conditions differ according to the installed environment.

"Standard insulation" (00) allows system to rapidly respond to the cooling or heating load changes.

"High insulation" (01) is when the heat insulation structure of the building is high and does not require system to rapidly respond to cooling or heating load changes.

When "High insulation" (01) is selected;

- Overheating (overcooling) is prevented at the start-up.
- All room temp. control settings (Function 30, 31) will reset to "No correction" [0.0°F (0.0°C)].

(◆... Factory setting)

Function number	Setting value	Setting description
95	00	Standard insulation ◆
	01	High insulation

### ■ Room temperature control for indoor unit sensor

Depending on the installed environment, correction of the room temperature sensor may be required.

Select the appropriate control setting according to the installed environment.

The temperature of the room temperature sensor is corrected as follows:

Corrected temp. = Temp. of room temp. sensor - correction temp. value

Example of correction :

When the temperature of room temp. sensor is 78 °F and the setting value is

"03" (-2 °F), the corrected temp. will be 80 °F (78 °F [-2 °F]).

The temperature correction values show the difference from the "Standard setting" (00) (manufacturer's recommended value).

(◆... Factory setting)

Function number	Setting value	Setting description	
30 (For cooling)	31 (For heating)	00	Standard setting ◆
		01	No correction 0 °F (0.0 °C)
		02	-1 °F (-0.5 °C)
		03	-2 °F (-1.0 °C)
		04	-3 °F (-1.5 °C)
		05	-4 °F (-2.0 °C)
		06	-5 °F (-2.5 °C)
		07	-6 °F (-3.0 °C)
		08	-7 °F (-3.5 °C)
		09	-8 °F (-4.0 °C)
		10	+1 °F (+0.5 °C)
		11	+2 °F (+1.0 °C)
		12	+3 °F (+1.5 °C)
		13	+4 °F (+2.0 °C)
		14	+5 °F (+2.5 °C)
		15	+6 °F (+3.0 °C)
		16	+7 °F (+3.5 °C)
17	+8 °F (+4.0 °C)		

More  
Cooling  
Less  
Heating

Less  
Cooling  
More  
Heating

## ■ Setting record

Record any changes to the settings in the following table.

Function number	Setting Description	Setting Value
95	Heat Insulation condition (building insulation)	
30	Room temperature control for indoor unit	Cooling
31	sensor	Heating

After completing the Function setting, be sure to disconnect the power and reconnect it again.

## 7. OPTIONAL KIT INSTALLATION

[For indoor unit]

### 7.1. Installing the WLAN adapter

#### 7.1.1. Installing the WLAN adapter

- For setting the WLAN adapter, refer to the operation manual.

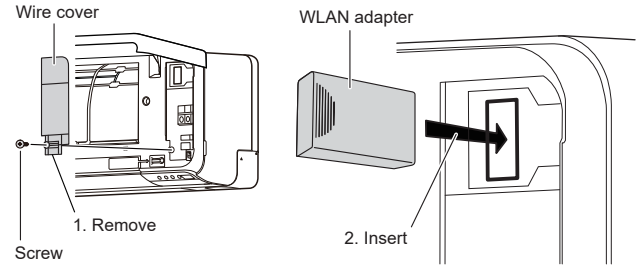

**NOTE:** When the WLAN adapter is supplied with an information label, attach the label at a position where it can be seen, or store it.

## 8. INSTALLATION WORK

[For outdoor unit]

Make sure to obtain the customer's approval for selecting and installing the outdoor unit.

### 8.1. Selecting an installation location

#### ⚠ WARNING

- Securely install the outdoor unit at a location that can withstand the weight of the unit. Otherwise, the outdoor unit may fall and cause injury.
- Be sure to install the outdoor unit as prescribed, so that it can withstand earthquakes and typhoons or other strong winds. Improper installation can cause the unit to topple or fall, or other accidents.
- To deal with unpredictable weather conditions caused by climate change, fix the outdoor unit(s) to mounting racks or mounting lifters with bolts securely. In addition, consider reinforcing the fixing with strapping down, caging, adding fixtures, etc., so that it can withstand unpredictable high-velocity winds. Failing to follow these requirements can result in system damage, system failure, personal injury, structural damage, or other property damage. We will assume no responsibility in regards to failures, other defects, and damages incurred by improper installation, such as ignorance of regulatory guidelines or other local codes.
- Do not install the outdoor unit near the edge of a balcony. Otherwise, children may climb onto the outdoor unit and fall off of the balcony.

**CAUTION**

- Do not install the outdoor unit in the following areas:
  - Area with high salt content, such as at the seaside. It will deteriorate metal parts, causing the parts to fail or the unit to leak water.
  - Area filled with mineral oil or containing a large amount of splashed oil or steam, such as a kitchen. It will deteriorate plastic parts, causing the parts to fail or the unit to leak water.
  - Area that generates substances that adversely affect the equipment, such as sulfuric gas, chlorine gas, acid, or alkali. It will cause the copper pipes and brazed joints to corrode, which can cause refrigerant leakage.
  - Area containing equipment that generates electromagnetic interference. It will cause the control system to malfunction, preventing the unit from operating normally.
  - Area that can cause combustible gas to leak, contains suspended carbon fibers or flammable dust, or volatile inflammables such as paint thinner or gasoline. If gas leaks and settles around the unit, it can cause a fire.
  - Area that has heat sources, vapors, or the risk of the leakage of flammable gas in the vicinity.
  - Area where small animals may live. It may cause failure, smoke or fire if small animals enter and touch internal electrical parts.
  - Area where animals may urinate on the unit or ammonia may be generated.
- Do not tilt the outdoor unit more than 3 degrees. However, do not install the unit with it tilted towards the side containing the compressor.
- Install the outdoor unit in a well-ventilated location away from rain or direct sunlight.
- If the outdoor unit must be installed in an area within easy reach of the general public, install as necessary a protective fence or the like to prevent their access.
- Install the outdoor unit in a location that would not inconvenience your neighbors, as they could be affected by the airflow coming out from the outlet, noise, or vibration. If it must be installed in proximity to your neighbors, be sure to obtain their approval.
- If the outdoor unit is installed in a cold region that is affected by snow accumulation, snow fall, or freezing, take appropriate measures to protect it from those elements. To ensure a stable operation, install inlet and outlet ducts.
- Install the outdoor unit in a location that is away from exhaust or the vent ports that discharge vapor, soot, dust, or debris.
- Install the indoor unit, outdoor unit, power supply cable, connection cable, and remote controller cable at least 40 in (1 m) away from a television or radio receivers. The purpose of this is to prevent TV reception interference or radio noise. (Even if they are installed more than 40 in (1 m) apart, you could still receive noise under some signal conditions.)
- If children under 10 years old may approach the unit, take preventive measures so that they cannot reach the unit.
- Keep the length of the piping of the indoor and outdoor units within the allowable range.
- For maintenance purposes, do not bury the piping.
- In places where the outdoor temperature drops to 0 °C or lower, the drain water may freeze and may stop up the drain or cause other outdoor unit trouble. Therefore take measures so that the drain water will not freeze and clog the drain.
- Set up the outdoor unit in a high place, and do not arrange the frame of installed stand under the drain port. Because the water dropped from the drain port repeats freezing and accumulating, and may block the drain port.

Decide the mounting position with the customer as follows:

- Install the outdoor unit in a location which can withstand the weight of the unit and vibration, and which can install horizontally.
- Provide the indicated space to ensure good airflow.
- If possible, do not install the unit where it will be exposed to direct sunlight. (If necessary, install a blind that does not interfere with the airflow.)
- Do not install the unit near a source of heat, steam, or flammable gas.
- During heating operation, drain water flows from the outdoor unit. Therefore, install the outdoor unit in a place where the drain water flow will not be obstructed.
- Do not install the unit where strong wind blows or where it is very dusty.
- Do not install the unit where people pass.
- Install the outdoor unit in a place where it will be free from being dirty or getting wet by rain as much as possible.
- Install the unit where connection to the indoor unit is easy.

**8.2. Drain installation**

**CAUTION**

- Perform drain work in accordance with this Manual, and ensure that the drain water is properly drained. If the drain work is not carried out correctly, water may drip down from the unit, wetting the furniture.
- When the outdoor temperature is 32°F (0°C) or less, do not use the accessory drain pipe. If the drain pipe is used, the drain water in the pipe may freeze in extremely cold weather.

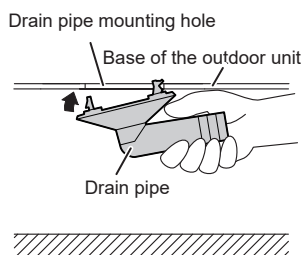

Since the drain water flows out of the outdoor unit during heating operation, install the drain pipe and connect it to a commercial 5/8 in (16 mm) hose. When installing the drain pipe, plug all the holes other than the drain pipe mounting hole in the bottom of the outdoor unit with putty so there is no water leakage.

[Unit: in (mm)]

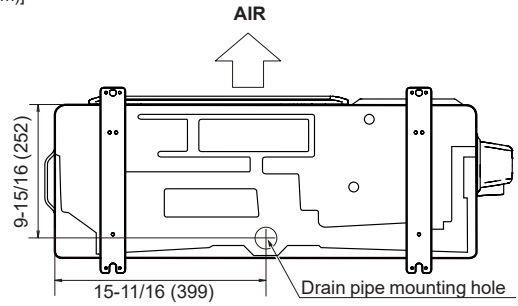

**8.3. Installation dimensions**

**CAUTION**

Keep the space shown in the installation examples. If the installation is not performed accordingly, it could cause a short circuit and result in a lack of operating performance.

**8.3.1. Outdoor unit installation**

When the upper space is open [Unit: in (mm)]

(1) Obstacles at rear only

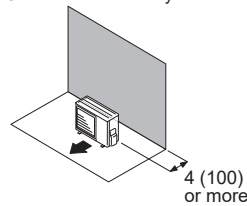

(2) Obstacles at rear and sides

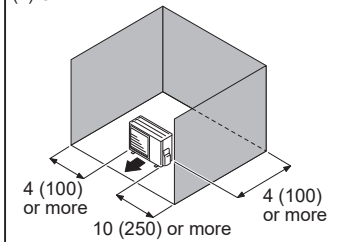

(3) Obstacles at front

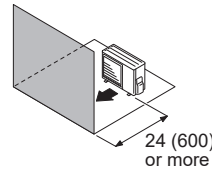

(4) Obstacles at front and rear

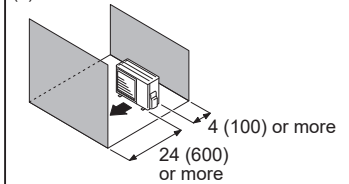

When an obstruction in the upper space [Unit: in (mm)]

(1) Obstacles at rear and above

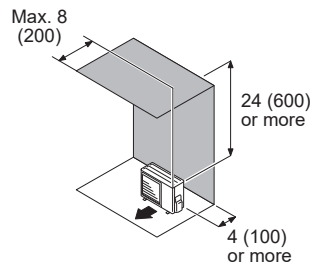

(2) Obstacles at rear, sides, and above

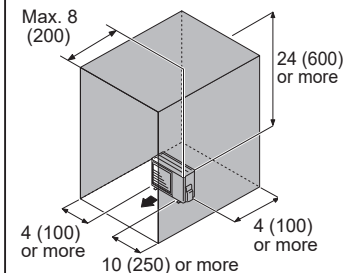

**8.4. Installation**

- Install 4 anchor bolts at the locations indicated with arrows in the figure.
- To reduce vibration, do not install the unit directly on the ground. Install it on a secure base (such as concrete blocks).
- Depending on the installation conditions, the outdoor unit may spread its vibration during operation, which may cause noise and vibration. Therefore, attach damping materials (such as damping pads) to the outdoor unit during installation.
- Install the foundation, making sure that there is enough space for installing the connection pipes.
- Secure the unit to a solid block using foundation bolts. (Use 4 sets of commercially available M10 bolts, nuts, and washers.)
- The bolts should protrude 1 in (20 mm). (Refer to the figure.)
- If overturning prevention is required, purchase the necessary commercially available items.
- The foundation shall support the legs of the unit and have a width of 2 in (50 mm) or more.

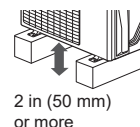

**CAUTION**

- Do not install the outdoor unit in two-stage where the drain water could freeze. Otherwise the drainage from the upper unit may form ice and cause a malfunction of the lower unit.
- In the area with heavy snowfall, if the intake and outlet of outdoor unit is blocked with snow, it might become difficult to get warm and it is likely to cause of the breakdown. Construct a canopy or baffle board (local configured).
- If the unit is installed in a region that is exposed to high winds, freezing conditions, freezing rain, snow fall or heavy snow accumulation, take appropriate measures to protect it from those elements. To ensure stable operation, the outdoor unit must be installed on a raised stand or rack, at or above the anticipated snow depth for the region. The installation of snow hoods and drift prevention fencing is recommended when blowing and drifting snow is common to the region.

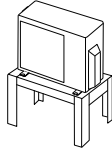

[ Unit: in (mm) ]

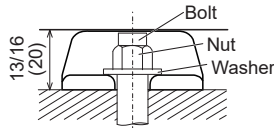
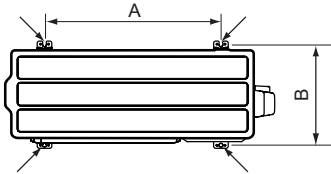

A	B
22-13/16 (580)	13 (330)

## 9. ELECTRICAL WIRING

[For outdoor unit]

### 9.1. Switch cover removal

#### 9.1.1. Switch cover removal

- (1) Remove the screws.
- (2) Slide the switch cover downwards to release.

#### 9.1.2. Installing the switch cover

- (1) After inserting the hooks (2 places) on the switch cover into the hole on the outdoor unit, slide the switch cover upwards.
- (2) Replace the screws.

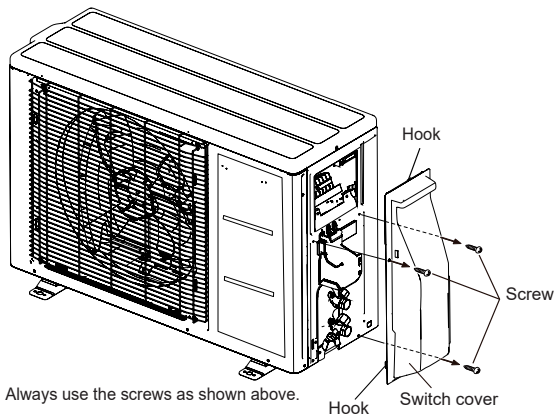

### 9.1.3. Conduit installation

- (1) Remove the screw, then remove the conduit cover.
- (2) Fasten the Inter-unit wire harness and power supply to the conduit holder using the lock nut.
- (3) Connect inter-unit wire harness and power supply to the terminal.
- (4) Use the screw to install the conduit cover.

#### NOTES:

- Connector trade size for this unit is 1/2 inch. The connector can be bought at a hard ware store. Refer to "9.2. Notes for electrical wiring ■ How to connect wiring to the terminal".
- The fuse located in the outdoor unit provides power supply protection and may blow when power is applied if the system has been incorrectly wired.

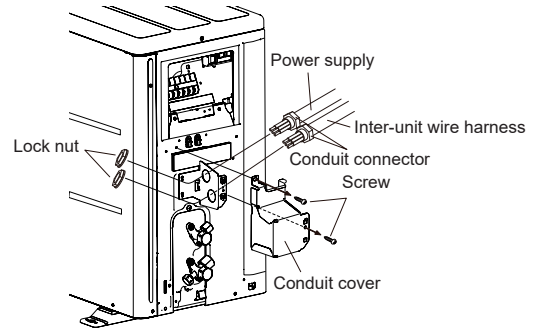

### 9.2. Notes for electrical wiring

**WARNING**

- Wiring connections must be performed by a qualified person in accordance with the specifications.
- Before connecting the wires, make sure the power supply is off.
- Never touch electrical components immediately after the power supply has been turned off. Electrical shock may occur. After turning off the power, always wait 10 minutes or more before touching electrical components.
- Use a dedicated power supply circuit. Insufficient power capacity in the electrical circuit or improper wiring may cause electric shock or fire.
- Be sure to install an earth leakage breaker. Otherwise, it will cause electric shock or fire.
- A circuit breaker is installed in the permanent wiring. Always use a circuit that can trip all the poles of the wiring and has an isolation distance of at least 1/8 in (3 mm) between the contacts of each pole.
- Use designated cables and power cables. Improper use may cause electric shock or fire by poor connection, insufficient insulation, or over current.
- Do not modify power cable, use extension cable or branch wiring. Improper use may cause electric shock or fire by poor connection, insufficient insulation or over current.
- Connect the connector cable securely to the terminal. Check no mechanical force bears on the cables connected to the terminals. Faulty installation can cause a fire.
- Use ring terminals and tighten the terminal screws to the specified torques, otherwise, abnormal overheating may be produced and possibly cause serious damage inside the unit.
- Make sure to secure the insulation portion of the connector cable with the cable clamp. Damaged insulation can cause a short circuit.
- Fix cables so that cables do not make contact with the pipes (especially on high pressure side). Do not make power supply cable and transmission cable come in contact with valves (Gas).
- Never install a power factor improvement condenser. Instead of improving the power factor, the condenser may overheat.
- Be sure to perform the grounding work.
  - Do not connect grounding wires to a gas pipe, water pipe, lightning rod or grounding wire for a telephone.
    - Connection to a gas pipe may cause a fire or explosion if gas leaks.
    - Connection to a water pipe is not an effective grounding method if PVC pipe is used.
    - Connection to the grounding wire of a telephone or to a lightning rod may cause a dangerously abnormal rise in the electrical potential if lightning strikes.
    - Improper grounding work can cause electric shocks.
- Securely install the electrical box cover on the unit. An improperly installed service panel can cause serious accidents such as electric shock or fire through exposure to dust or water.
- Do not connect the AC power supply to the transmission line terminal board. Improper wiring can damage the entire system.

## ⚠ CAUTION

- The primary power supply capacity is for the air conditioner itself, and does not include the concurrent use of other devices.
- If the electrical power is inadequate, contact your electric power company.
- Install a breaker in a location that is not exposed to high temperatures. If the temperature surrounding the breaker is too high, the amperage at which the breaker cuts out may decrease.
- When using an earth leakage breaker that has been designed solely for ground fault protection, be sure to install a fuse-equipped switch or circuit breaker.
- This system uses an inverter, which means that it must be used an earth leakage breaker that can handle harmonics in order to prevent malfunctioning of the earth leakage breaker itself.
- Do not use crossover power supply wiring for the outdoor unit.
- If the temperature surrounding the breaker is too high, the amperage at which the breaker cuts out may decrease.
- When the electrical switchboard is installed outdoors, place it under lock and key so that it is not easily accessible.
- Start wiring work after closing branch switch and over current breaker.
- Be sure not to remove thermistor sensor etc. from power wiring and connection wiring. Compressor may fail if operated while removed.
- Always keep to the maximum length of the connection cable. Exceeding the maximum length may lead to erroneous operation.
- Do not start operation until the refrigerant is charged completely. The compressor will fail if it is operated before the refrigerant piping charging is complete.
- The static electricity that is charged to the human body can damage the control PC Board when handling the control PC Board for address setting, etc. Keep caution to the following points. Provide the grounding of Indoor unit, Outdoor unit and Option equipment. Cut off the power supply (breaker). Touch the metal section (such as the unpainted control box section) of the indoor or outdoor unit for more than 10 seconds. Discharge the static electricity in your body. Never touch the component terminal or pattern on the PC Board.
- Be careful not to generate a spark as follows for using a flammable refrigerant.
  - Do not remove the fuse while power is on.
  - Do not disconnect plug from the wall outlet and the wiring while the power is on.
  - It is recommended to position the outlet connection in a high position. Place the cords so that they do not get tangled.
- Confirm the indoor unit model name before connecting.

### ■ How to connect wiring to the terminal

#### Caution when wiring cable

- When stripping off the coating of a lead wire, always use a special tool such as a wire stripper. If there is no special tool available, carefully strip the coating with a knife etc.
  - (1) Use ring terminals with insulating sleeves as shown in the figure below to connect to the terminal block.
  - (2) Securely clamp the ring terminals to the wires using an appropriate tool so that the wires do not come loose.

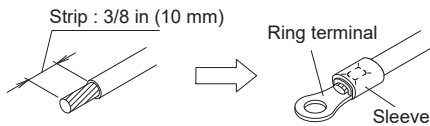

- (3) Use the specified wires, connect them securely, and fasten them so that there is no stress placed on the terminals.
- (4) Use an appropriate screwdriver to tighten the terminal screws. Do not use a screwdriver that is too small, otherwise, the screw heads may be damaged and prevent the screws from being properly tightened.
- (5) Do not tighten the terminal screws too much, otherwise, the screws may break.

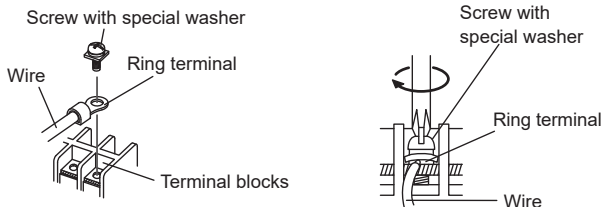

- (6) Refer to the following table for the terminal screw tightening torques.

Tightening torque [lbf-in (N·m)]	
M3.5 screw	7.0 to 8.8 (0.8 to 1.0)
M4 screw	10.6 to 15.9 (1.2 to 1.8)
M5 screw	17.7 to 26.5 (2.0 to 3.0)

## 9.3. Wiring method

### ■ Connection diagrams

## ⚠ CAUTION

When connecting the power supply cable, make sure that the phase of the power supply matches with the phase of the terminal board. If the phases do not match, the compressor will rotate in reverse and will not be able to compress.

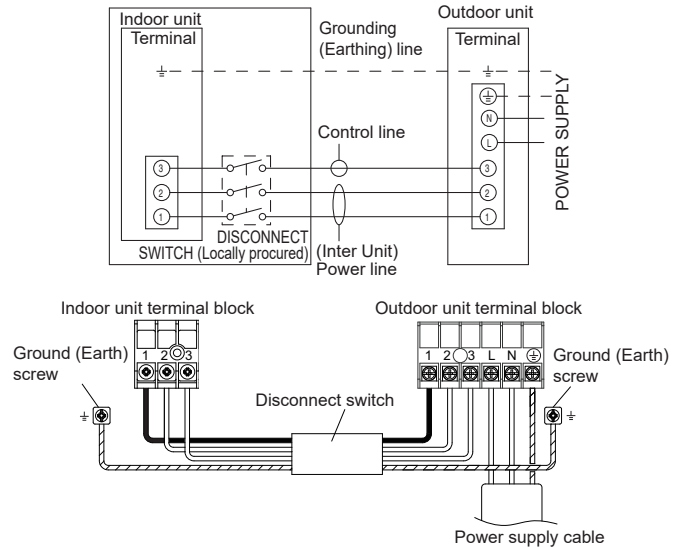

**NOTE:** Factory installed protective inline fuses for indoor units' conductors are installed on the Power Supply PCB.

### ■ Cable preparation

Keep the ground (earth) wire longer than the other wires.

**NOTE:** When using a sealed cable

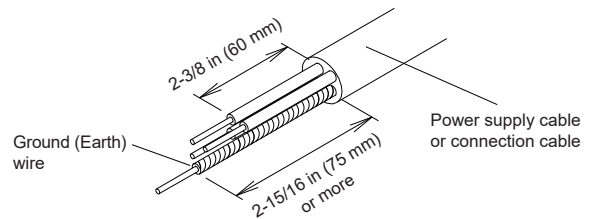

### ■ Wiring procedure

- (1) Remove the outdoor unit switch cover. (Refer to "9.1. Switch cover removal".)
- (2) Remove the outdoor unit conduit cover. (Refer to "9.1.3. Conduit installation".)
- (3) Connect the power supply cable and the connection cable to terminal.
- (4) Fasten the power supply cable and connection cable with cable tie (accessory).
- (5) Install the conduit cover. (Refer to "9.1.3. Conduit installation".)

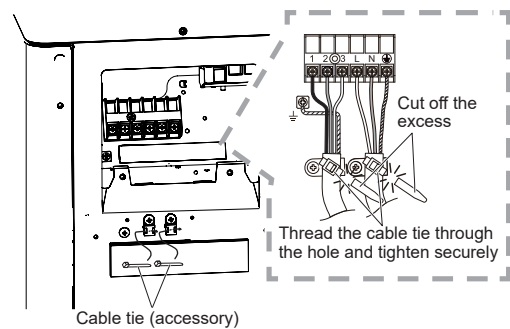

## 10. PIPE INSTALLATION

[For outdoor unit]

### 10.1. Pipe connection

#### CAUTION

- Do not use mineral oil on a flared part. Prevent mineral oil from getting into the system as this would reduce the lifetime of the units.
- While welding the pipes, be sure to blow dry nitrogen gas through them.

#### Flaring

- (1) Cut the connection pipe to the necessary length with a pipe cutter.
- (2) Hold the pipe downward so that cuttings will not enter the pipe and remove the burrs.
- (3) Insert the flare nut onto the pipe and flare the pipe with a flaring tool.

Insert the flare nut (always use the flare nut attached to the indoor and outdoor units respectively) onto the pipe and perform the flare processing with a flare tool.

Use the special R32(R410A) flare tool, or the conventional (for R22) flare tool.

When using the conventional flare tool, always use an allowance adjustment gauge and secure the A dimension shown in the following table.

Check if [L] is flared uniformly and is not cracked or scratched.

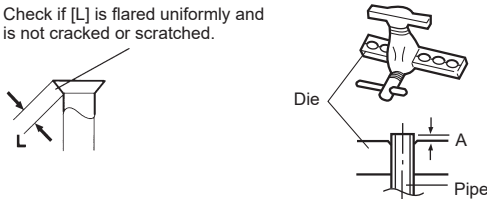

Pipe outside diameter [in (mm)]	A [in (mm)]
	Flaring tool for R32 or R410A, clutch type
1/4 (6.35)	0 to 0.020 (0 to 0.5)
3/8 (9.52)	
1/2 (12.70)	
5/8 (15.88)	
3/4 (19.05)	

#### Bending pipes

- (1) When bending the pipe, be careful not to crush it.
- (2) To prevent breaking of the pipe, avoid sharp bends. Bend the pipe with a radius of curvature of 2-3/4 in (70 mm) or more.
- (3) If the copper pipe is bent too often, it will become stiff. Do not bend the pipes more than three times at one place.

#### Flare connection

- (1) Detach the caps and plugs from the pipes.

#### CAUTION

- Be sure to apply the pipe against the port on the indoor unit and the outdoor unit correctly. If the centering is improper, the flare nut cannot be tightened smoothly. If the flare nut is forced to turn, the threads will be damaged.
- Do not remove the flare nut from the indoor unit pipe until immediately before connecting the connection pipe.

- (2) Centering the pipe against port on the outdoor unit, turn the flare nut with your hand.

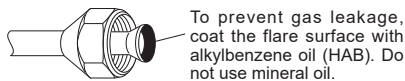

- (3) Tighten the flare nut of the connection pipe at the outdoor unit valve connector.

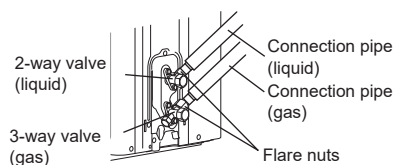

- (4) When the flare nut is tightened properly by your hand, use a torque wrench to finally tighten it.

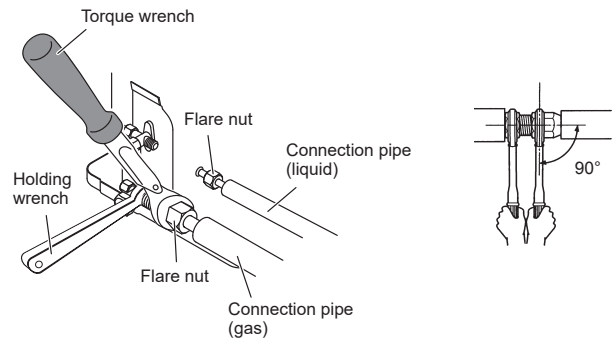

#### CAUTION

Hold the torque wrench at its grip, keeping it in the right angle with the pipe, in order to tighten the flare nut correctly.

Flare nut [in (mm)]	Tightening torque [lbf-ft. (N-m)]
1/4 (6.35) dia.	11.8 to 13.3 (16 to 18)
3/8 (9.52) dia.	23.6 to 31.0 (32 to 42)
1/2 (12.70) dia.	36.1 to 45.0 (49 to 61)
5/8 (15.88) dia.	46.5 to 55.3 (63 to 75)
3/4 (19.05) dia.	66.4 to 81.1 (90 to 110)

#### CAUTION

- Fasten a flare nut with a torque wrench as instructed in this manual. If fastened too tight, the flare nut may be broken after a long period of time and cause a leakage of refrigerant.
- During installation, make sure that the refrigerant pipe is attached firmly before you run the compressor. Do not operate the compressor under the condition of refrigerant piping not attached properly with 3-way valves open. This may cause abnormal pressure in the refrigeration cycle that leads to breakage and even injury.

### 10.2. Vacuuming process and leak test

#### CAUTION

- Be sure to evacuate the refrigerant system using a vacuum pump.
- The refrigerant pressure may sometimes not rise when a closed valve is opened after the system is evacuated using a vacuum pump. This is caused by the closure of the refrigerant system of the outdoor unit by the electronic expansion valve. This will not affect the operation of the unit.
- If the system is not evacuated sufficiently, its performance will drop.
- Use a clean gauge manifold and charging hose that were designed specifically for use with R32(R410A). Using the same vacuum equipment for different refrigerants may damage the vacuum pump or the unit.
- Do not purge the air with refrigerants, but use a vacuum pump to evacuate the system.

#### Refrigerant for purging the air is not charged in the outdoor unit at the factory.

- (1) Remove the charging port cap, and connect the gauge manifold and the vacuum pump to the charging port by the charge hoses.
- (2) Vacuum the indoor unit and the connecting piping, confirm that the pressure gauge indicates  $-0.1$  MPa [Gauge] ( $-760$  mmHg). Vacuuming is performed for at least 10 minutes.
- (3) When vacuuming is finished, close the gauge manifold valve and stop the vacuum pump.
- (4) Leave as it is for one or two minutes. Make sure pointer gauge manifold remains in the same position. Confirm that pressure gauge shows  $-0.1$  MPa [Gauge] ( $-760$  mmHg).
- (5) Disconnect the charge hoses and fit the cap to the charging port to the specified torque.
- (6) Remove the blank caps, and fully open the spindles of the valves on both sides of gas pipe and liquid pipe with the hexagonal wrench. (Open unit it lightly hits the stopper.)
- (7) Tighten the blank caps to the specified torque.
- (8) Perform a leak test.

		Tightening torque [lbf-ft (N-m)]
Blank cap [in (mm)]	1/4 (6.35)	14.8 to 18.4 (20 to 25)
	3/8 (9.52)	14.8 to 18.4 (20 to 25)
	1/2 (12.70)	20.7 to 23.6 (28 to 32)
	5/8 (15.88)	22.1 to 25.8 (30 to 35)
	3/4 (19.05)	25.8 to 29.5 (35 to 40)
Charging port cap		9.2 to 11.8 (12.5 to 16)

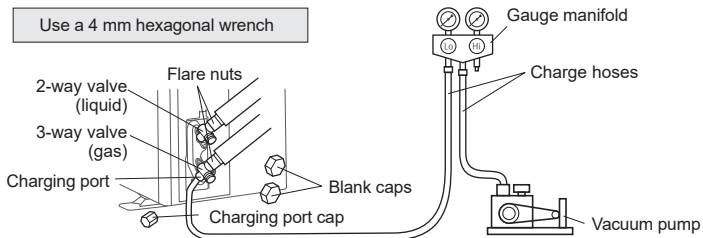

### 10.3. Additional charging

#### WARNING

When moving and installing the air conditioner, do not mix gas other than the specified refrigerant R32 inside the refrigerant cycle. If air or other gas enters the refrigerant cycle, the pressure inside the cycle will rise to an abnormally high value and cause breakage, injury, etc.

Charge the refrigerant following the instruction in "2.6. Additional charge".

#### CAUTION

- After vacuuming the system, add refrigerant.
- Do not reuse recovered refrigerant.
- When charging the refrigerant R32, always use an electronic scales for refrigerant charging (to measure the refrigerant by weight). Adding more refrigerant than the specified amount will cause a malfunction.
- Be sure to use the special tools for R32 (R410A) for pressure resistance and to avoid mixing of impure substances.
- If the units are further apart than the maximum pipe length, correct operation can not be guaranteed.
- Make sure to back closing valve after refrigerant charging. Otherwise, the compressor may fail.
- Minimize refrigerant release to the air. Excessive release is prohibited under the Freon Collection and Destruction Law.

#### Gas leakage inspection

#### CAUTION

After connecting the piping, check the all joints for gas leakage with gas leak detector.

### 10.4. Installing insulation

- Install insulation material after conducting "10.2. Vacuuming process and leak test".
- To prevent condensation and water droplets, install insulation material on the refrigerant pipe.
- Use insulation with heat resistance above 248°F (120°C).
- Refer to the table to determine the thickness of the insulation material.

#### Selection of insulation

(Use an insulation material with equal heat transmission rate or below 0.022 BTU/(ft·hr·°F) [0.040 W/(m·K)])

		Insulation material minimum thickness [in (mm)]			
		≤ 70%	≤ 75%	≤ 80%	≤ 85%
Pipe diameter [in (mm)]	1/4 (6.35)	5/16 (8)	3/8 (10)	1/2 (13)	11/16 (17)
	3/8 (9.52)	3/8 (9)	7/16 (11)	9/16 (14)	11/16 (18)
	1/2 (12.70)	3/8 (10)	1/2 (12)	9/16 (15)	3/4 (19)
	5/8 (15.88)	3/8 (10)	1/2 (12)	5/8 (16)	13/16 (20)
	3/4 (19.05)	3/8 (10)	1/2 (13)	5/8 (16)	13/16 (21)

\* When the ambient temperature and relative humidity exceed 89.6°F (32°C) (DB) and 85% respectively, strengthen the heat insulation of refrigerant pipe.

## 11. FINISHING

- Insulate between pipes.
  - Insulate suction and discharge pipes separately.
  - Butt the connection pipe heat insulation and indoor unit pipe heat insulation together and bind them with vinyl tape so that there is no gap.
  - For left and left rear piping, wrap the area which accommodates the rear piping housing section with cloth tape. (Wrap cloth tape by overlapping at least half the width of the tape with each turn.)
- Temporarily fasten the connection cable along the connection pipe with vinyl tape. (Wrap to about 1/3 the width of the tape from the bottom of the pipe so that water does not enter.)
- Fasten the connection pipe to the outside wall with a saddle, etc.
- Fill the gap between the outside wall pipe hole and the pipe with sealer so that rain water and wind cannot blow in.
- Fasten the drain hose to the outside wall, etc.
- Check the drainage.

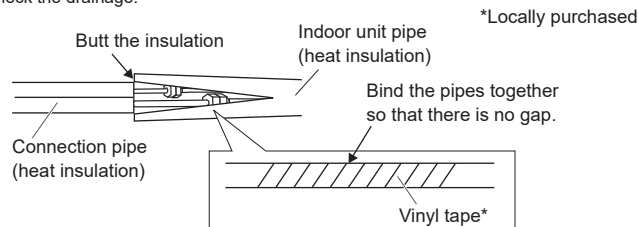

#### For left rear and left piping

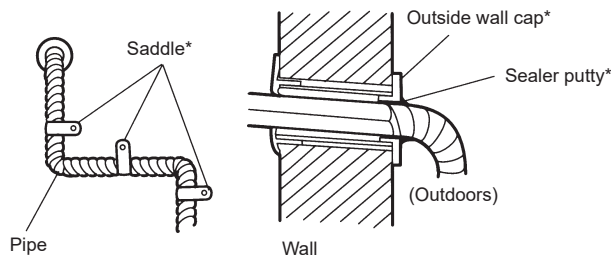
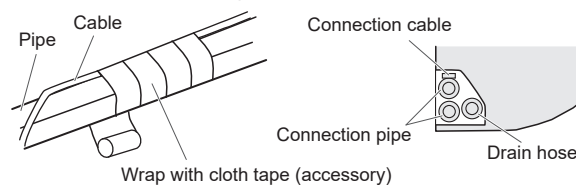

#### GOOD

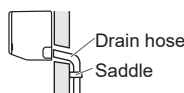

#### PROHIBITED

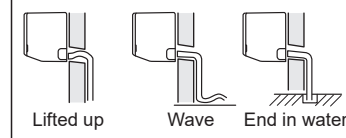

## 12. TEST RUN

### ■ Check items

- (1) Is operation of each button on the remote control unit normal?
- (2) Does each lamp light normally?
- (3) Do air flow direction louvers operate normally?
- (4) Is the drain normal?
- (5) Do not have an abnormal noise and vibration during operation?
- (6) Is there an error left in the error memory?

- After installation, check that the display is "00 (normal)".  
(For checking whether the display shows "00", refer to "■Service check in the Operation manual".)  
- If the display is other than "00 (normal)" even though it works normally, erase the error memory  
- For "■How to check the error memory" and "■How to erase the error memory", refer to the lower section of the "14. ERROR CODES" list.

- Do not operate the air conditioner in test run for a long time.  
(If you leave it as it is after the test run starts, it will end automatically in about 60 minutes.)

### ■ Operation method

Before starting the test run, wait for 1 minute after connecting the power supply.

By the wireless remote controller

- To start the test run, press [START/STOP(⏻/⏻)], press and hold [WLAN] on the remote control for 5 seconds or more by using the tip of a ballpoint pen or other small object.

By the indoor unit

- To start the test run, keep on pressing the indoor unit button for more than 10 seconds.
- To end test operation, press the remote controller [START/STOP(⏻/⏻)].

(When the air conditioner is running by pressing [WLAN], the "OPERATION" Lamp and "TIMER" Lamp will simultaneously flash slowly.)

## 13. CUSTOMER GUIDANCE

Explain the following to the customer in accordance with the operation manual:

- (1) Starting and stopping method, operation switching, temperature adjustment, timer, airflow switching, and other remote control unit operations.
- (2) Air filter removal and cleaning, and how to use the air louvers.
- (3) Give the operation manual to the customer.

## 14. ERROR CODES

When using a wireless remote controller, LED lamps on the indoor unit indicates error code by blinking pattern. See the lamp blinking patterns and error codes in the table.  
An error display is displayed only during operation.

The error code contains errors irrelevant to this product as well.

### [Troubleshooting with the indoor unit display]

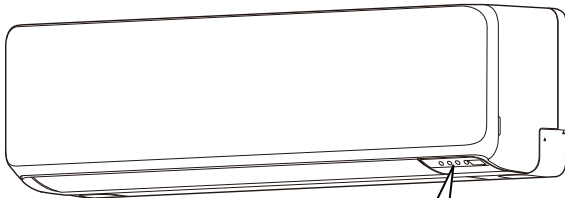

LED1: OPERATION indicator lamp (green)

LED2: TIMER indicator lamp (orange)

LED3: ECONOMY indicator lamp (green)

If error code 24 is indicated.

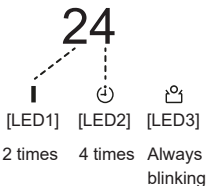

The first and second digits of the error code are indicated by the number of times the lamp blinks.

[Blinking interval]

LED1,2 : 0.5s ON / 0.5s OFF

LED3 : 0.1s ON / 0.1s OFF (Always blinking)

\*The alphabet is indicated by the following number of times the lamp blinks.

A : 10 times C : 11 times J : 13 times U : 15 times

- Unnecessary error codes for this product may be included in the list.
- If you find any unlisted error codes, please contact to service staff.

Error code	Description
11	Serial communication error
12	Wired remote controller communication error
15	Check run unfinished Automatic airflow adjustment error
16	Peripheral unit transmission PCB connection error
18	External communication error
21	Unit number or Refrigerant circuit address setting error [simultaneous multi-split type]
22	Indoor unit capacity error
23	Combination error
24	• Connection unit number error (indoor secondary unit) [simultaneous multi-split type] • Connection unit number error (indoor unit or branch unit) [flexible multi-split type]
26	Indoor unit address setting error
27	Primary unit, secondary unit setup error [simultaneous multi-split type]
29	Connection unit number error in wired remote controller system
31	Power supply interruption error
32	Indoor unit PCB model information error
33	Indoor unit motor electricity consumption detection error
35	Manual auto switch error
39	Indoor unit power supply error for fan motor
3A	Indoor unit communication circuit (wired remote controller) error
41	Room temp. sensor error
42	Indoor unit heat ex. middle temp. sensor error
44	Occupancy sensor error
51	Indoor unit fan motor error
53	Drain pump error
54	Electric air cleaner reverse VDD error
55	Filter set error
57	Damper error
58	Intake grille error
59	Indoor unit fan motor 2 error (Left side fan)
5A	Indoor unit fan motor 3 error (Right side fan)
5U	Indoor unit error

Error code	Description
61	Outdoor unit reverse/missing phase and wiring error
62	Outdoor unit main PCB model information error or communication error
63	Inverter error
64	Active filter error, PFC circuit error
65	• Trip terminal L error • IPM temp error
68	Outdoor unit rush current limiting resistor temp. rise error
6A	Display PCB microcomputers communication error
71	Discharge temp. sensor error
72	Compressor temp. sensor error
73	Outdoor unit Heat Ex. liquid temp. sensor error
74	Outdoor temp. sensor error
75	Suction Gas temp. sensor error
76	• 2-way valve temp. sensor error • 3-way valve temp. sensor error
77	Heat sink temp. sensor error
82	• Sub-cool Heat Ex. gas inlet temp. sensor error • Sub-cool Heat Ex. gas outlet temp. sensor error
83	Liquid pipe temp. sensor error
84	Current sensor error
86	• Discharge pressure sensor error • Suction pressure sensor error • High pressure switch error
94	Trip detection
95	Compressor rotor position detection error (permanent stop)
97	Outdoor unit fan motor 1 error
98	Outdoor unit fan motor 2 error
99	4-way valve error
9A	Coil (expansion valve) error
A1	Discharge temp. error
A3	Compressor temp. error
A4	High pressure error
A5	Low pressure error
AC	Heat sink temp error
J2	Branch boxes error [flexible multi-split type]

### ■ How to check the error memory

When an error occurs, the operation lamp (Green) and the timer lamp (Orange) indicate the error content by blinking. To check the error memory, follow the procedures below.

1. Stop the operation of the air conditioner, and then disconnect the power supply.
2. Reconnect the power supply.
3. In one of the following two methods, the memorized error is only displayed during the "3 minutes ST\*\*" state period.
  - Start the operation and then press hold [WLAN] on the remote controller for 5 seconds or more.or
  - Press hold [MANUAL AUTO] on the indoor unit for 10 seconds or more.

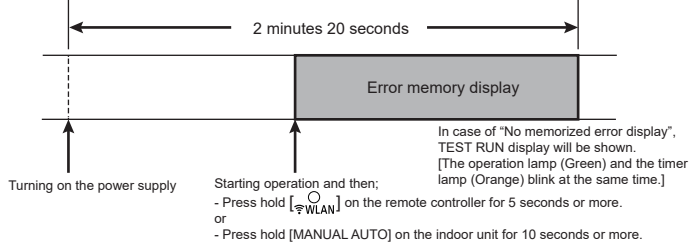

\*: The "3 minutes ST" period lasts 2 minutes and 20 seconds after turning on the power supply.

### ■ How to erase the error memory

- Manual erase: Pressing [MANUAL AUTO] on the indoor unit while the "Error memory display" is being shown. (Short beep emits for about 3 seconds.)