

Air conditioner

Installation manual

AC*DX*****

- Thank you for purchasing this Samsung air conditioner.
- Before operating this unit, please read this manual carefully and retain it for future reference.

Contents

Safety Information	3
General information	4
Installing the unit	5
Installation Procedure	12
Step 1 Choosing the installation location	12
Step 2 Checking and preparing accessories and tools	18
Step 3 Fixing the outdoor unit in place	18
Step 4 Connecting the power cables, communication cable, and controllers	20
Step 5 Connecting the refrigerant pipe	30
Step 6 Optional: Cutting and flaring the pipes	31
Step 7 Connecting up and removing air in the circuit	32
Step 8 Performing the gas leak test	34
Step 9 Adding refrigerant (R-32)	35
Step 10 Connecting the drain hose to the outdoor unit	38
Step 11 Insulating the refrigerant pipes	39
Step 12 Checking the grounding	40
Step 13 Performing final check and trial operation	40
Extra procedures	45
Pumping down refrigerant	45
Relocating the indoor and outdoor units	45
Using the stop valve	46
Maintenance Procedures	47
Performing the gas leak tests for repair	47
Decommissioning	47
Installing the wind baffle	49
Appendix	51
Troubleshooting	51

Safety Information

California Proposition 65 Warning (US)

WARNING:

Cancer and Reproductive Harm - www.P65Warnings.ca.gov.

WARNING: Read This Manual

- Read and follow all safety information and instructions before installation, use, or maintenance of this appliance. Incorrect installation, use, or maintenance of this appliance can result in death, serious injury, or property damage. Keep these instructions with this appliance. This manual is subject to change. For the latest version, visit www.samsung.com.

IMPORTANT – This product has been designed and manufactured to meet ENERGY STAR criteria for energy efficiency when matched with appropriate coil components.

However, proper refrigerant charge and proper air flow are critical to achieve rated capacity and efficiency.

Installation of this product should follow the manufacturer's refrigerant charging and air flow instructions.

Failure to confirm proper charge and airflow may reduce energy efficiency and shorten equipment life.

Notices and notes

To make you aware of safety messages and highlighted information, we use the following notices and notes throughout this manual:

WARNING

Hazards or unsafe practices may result in severe personal injury or death.

CAUTION







Hazards or unsafe practices may result in minor personal injury or property damage.

IMPORTANT

- Information of special interest

NOTE

- Supplementary information that may be useful

Symbol	Meaning
	Flammable gas
	Flammable materials
	Refrigerant safety group
	Read installation manual
	Refer to installation manual
	Read service manual

WARNING

The installation and testing of this appliance must be performed by a qualified technician.

- The instructions in this manual are not intended as a substitute for proper training or adequate experience in the safe installation of the appliance.

Always install the air conditioner in compliance with current local, state, and federal safety standards.

Safety Information

General information

WARNING

- Carefully read the content of this manual before installing the air conditioner and store the manual in a safe place to be able to use it as a reference after installation.
- For maximum safety, installers should always carefully read the following warnings.
- Store the operation and installation manual in a safe location and remember to hand it over to the new owner if the air conditioner is sold or transferred.
- This manual explains how to install an indoor unit with a split system with two SAMSUNG units. Using other types of units with different control systems may damage the units and invalidate the warranty. The manufacturer shall not be responsible for damages arising from the use of non-compliant units.
- The manufacturer shall not be responsible for damage originating from unauthorized changes or the improper connection of electricity and requirements outlined in the "Operating limits" table, included in the manual, shall immediately invalidate the warranty.
- The air conditioner should be used only for the applications for which it has been designed: the indoor unit is not suitable to be installed in areas used for laundry.
- All pipe work including piping material, pipe routing, and installation shall include protection from physical damage in operation and service and comply with national and local codes and standards, such as ASHRAE 15, ASHRAE 15.2, IAPMO Uniform Mechanical Code, ICC International Mechanical Code, or CSA B52. Any field joints shall be accessible for inspection before being covered or enclosed.
- Do not use the units if damaged. If problems occur, switch the unit off and disconnect it from the power supply.
- To prevent electric shocks, fires or injuries, always stop the unit, disable the protection switch and contact SAMSUNG's technical support if the unit produces smoke, if the power cable is hot or damaged or if the unit is very noisy.
- Always remember to inspect the unit, electric connections, refrigerant tubes and protections regularly. These operations should be performed by qualified personnel only.
- The unit contains moving parts, which should always be kept out of the reach of children.
- Do not attempt to repair, move, alter or reinstall the unit. If performed by unauthorized personnel, these operations may cause electric shocks or fires.
- Do not place containers with liquids or other objects on the unit.
- All the materials used for the manufacture and packaging of the air conditioner are recyclable.
- The air conditioner contains a refrigerant that must be disposed of as special waste. At the end of its life cycle, the air conditioner must be disposed of in authorized centers or returned to the retailer so that it can be disposed of correctly and safely.
- Wear protective equipment (such as safety gloves, goggles, and headgear) during installation and maintenance work. Installation/repair technicians may be injured if improper protective equipment is worn.
- Do not use means to accelerate the defrost operation or to clean, other than those recommended by Samsung.
- Do not pierce or burn.
- Be aware that refrigerants may not contain an odor.
- This appliance is not intended for use by persons (including children) with reduced physical, sensory, or mental capabilities, or lack of experience and knowledge unless they have been given supervision or instruction concerning the use of the appliance by a person responsible for their safety. Children should be supervised to ensure that they do not play with the appliance.

Installing the unit

WARNING

IMPORTANT: When installing the unit, always remember to connect first the refrigerant tubes, and then the electrical lines.

- Connecting one indoor unit to this product is prohibited.
- Upon receipt, inspect the product to verify that it has not been damaged during transport. If the product appears damaged, DO NOT INSTALL it, and immediately report the damage to the carrier or retailer (if the installer or the authorized technician has collected the material from the retailer.)
- After completing the installation, always carry out a functional test and provide instructions on how to operate the air conditioner to the user.
- Do not use the air conditioner in environments with hazardous substances or close to equipment that releases free flames to avoid the occurrence of fires, explosions or injuries.
- Our units should be installed in compliance with the spaces shown in the installation manual, to ensure accessibility from both sides and allow repairs or maintenance operations to be carried out. The unit's components should be accessible and easy to disassemble without endangering people and objects.
- For this reason, when provisions of the installation manual are not complied with, the cost required to access and repair the units (in SAFETY CONDITIONS, as set out in prevailing regulations) with harnesses, ladders, scaffolding or any other elevation system will NOT be considered part of the warranty and will be charged to the end customer.
- Make sure that the condensed water runs well out of the unit at low ambient temperature. The base heater can frost/ice cannot grow. If drain work is not effective for releasing condensed water, it can make the units get damaged by massive ice and the system can be stopped, covered by ice. (AC018/024/030/036/048DXSCCG models)
- Do not disassemble and alter the heater at your discretion. (AC018/024/030/036/048DXSCCG, AC024/030/036DXSCCF models)
- The outdoor unit shall be installed in an open space that is always ventilated.
- Please adhere to the local gas regulations.
- To handle, purge, and dispose of the refrigerant, or to break into the refrigerant circuit, the technician should have a certificate from an industry-accredited authority.
- While in installation or relocation of the product, do not mix the refrigerant with other gases including air or unspecified refrigerant. Failure to do so may cause pressure increase to result in rupture or injury.
- Do not cut or burn the refrigerant container or piping.
- Use clean parts such as manifold gauge, vacuum pump, and charging hose for the refrigerant.
- Installation must be carried out by qualified personnel handling the refrigerant. Additionally, reference local and national regulations and laws.
- Be careful not to let foreign substances (lubricating oil, refrigerant, water, etc.) enter the pipes.
- When mechanical ventilation is required, ventilation openings shall be kept clear of obstruction.
- For disposal of the product, follow the local laws and regulations.
- Do not work in a confined place.
- The work area shall be secured to only allow access by the technician(s).
- The refrigerant pipes shall be installed in a position where there are no substances that may result in corrosion.

Safety Information

- The following checks shall be performed for installation:
 - The charge amount depends on the room size.
 - The ventilation devices and outlets are operating normally and are not obstructed.
 - Markings and signs on the equipment shall be visible and legible.
- Upon leakage of the refrigerant, ventilate the room. When the leaked refrigerant is exposed to flame, it may cause the generation of toxic gases.
- Make sure that the work area is safe from flammable substances.
- To purge air in the refrigerant pipes, be sure to use a vacuum pump.
- Note that the refrigerant has no odor.
- The units are not explosion proof so they must be installed with no risk of explosion.
- This product contains fluorinated gases that contribute to the global greenhouse effect. Accordingly, do not vent gases into the atmosphere.
- For installation with handling the refrigerant(R-32), use dedicated tools and piping materials. The working pressure of R-32 is higher than R410A, so failure to use the dedicated tools and piping materials may cause rupture or injury. Furthermore, it may cause serious accidents such as water leakage, electric shock or fire.
- Servicing shall be performed as recommended by the manufacturer. In case other skilled persons are joined for servicing; it shall be carried out under the supervision of the person who is competent in handling flammable refrigerants.
- For servicing the units containing flammable refrigerants, safety checks are required to minimize the risk of ignition.
- Servicing shall be performed following the controlled procedure to minimize the risk of flammable refrigerants or gases.
- Do not install where there is a risk of combustible gas leakage.
- Do not place near heat sources
- Be cautious not to generate a spark as follows:
 - Do not remove fuses with power on.
- If the indoor unit is not R-32 compatible, an error signal appears and the unit will not operate.
- After installation, check for leakage. Toxic gas may be generated if it comes into contact with an ignition source such as a fan heater or stove.
- Never directly touch any accidental leaking refrigerant. It could result in severe wounds caused by frostbite.

Preparation of fire extinguisher

- If flammable work is to be done, appropriate fire extinguishing equipment should be available.
- Have a dry CO₂ fire extinguisher adjacent to the charging area and workspace.

Ignition source safety

- Make sure to store the units in a place without continuously operating ignition sources (for example, open flames, an operating gas appliance or an operating electric heater).
- The service technician shall not use any ignition sources with the risk of fire or explosion.
- Potential ignition sources shall be kept away from the work area where the flammable refrigerant can be released into the surrounding area.
- The work area should be checked to ensure that there are no flammable hazards or ignition risks. The “No Smoking” sign shall be attached.

- Under no circumstances shall potential sources of ignition be used while detecting refrigerant leaks.
- Make sure that the seals or sealing materials have not degraded.
- Safe parts are the ones with which the worker can work in a flammable atmosphere. Other parts may result in ignition due to leakage.
- Replace components only with parts specified by Samsung. Other parts may result in the ignition of refrigerant in the atmosphere from a leak.

Area ventilation

- Make sure that the work area is well ventilated before performing hot work.
- Ventilation shall be made even during work.
- The ventilation should safely disperse any released gases and preferably expel them into the atmosphere.

Leakage detection methods

- The leakage detector shall be calibrated in a refrigerant-free area.
- Make sure that the detector is not a potential source of ignition.
- The leakage detector shall be set to the LFL (lower flammability limit).
- The use of detergents containing chlorine shall be avoided for cleaning because the chlorine may react with the refrigerant and corrode the piping.
- If leakage is suspected, naked flames shall be removed.
- If a leakage is found while brazing, the entire refrigerant charge shall be recovered from the product or isolated (e.g. using shut-off valves). It shall not be directly released into the environment. Oxygen free nitrogen (OFN) shall be used for purging the system before and during the brazing process.

- The work area shall be checked with an appropriate refrigerant detector before and during work.
- Ensure that the leakage detector is appropriate for use with flammable refrigerants.

Labeling

- The parts shall be labeled to ensure that they have been decommissioned and emptied of refrigerant.
- The labels shall note the date of application.
- Make sure that the labels are affixed on the system to notify it contains flammable refrigerant.

Recovery

- When removing refrigerant from the system for servicing or decommissioning, it is recommended to remove the entire refrigerant charge.
- When transferring refrigerant into cylinders, make sure that only refrigerant recovery cylinders are used.
- All cylinders used for the recovered refrigerant shall be labeled.
- Cylinders shall be equipped with pressure relief valves and shut-off valves in a proper order.
- Empty recovery cylinders shall be evacuated and cooled before recovery.
- The recovery system shall operate normally according to the specified instructions and shall be suitable for refrigerant recovery.
- In addition, the calibration scales shall operate normally.
- Hoses shall be equipped with leak-free disconnect couplings.
- Before starting the recovery, check for the status of the recovery system and sealing state. Consult with the manufacturer if suspected.

Safety Information

- The recovered refrigerant shall be returned to the supplier in the correct recovery cylinders with the Waste Transfer Note attached.
- Do not mix refrigerants in the recovery units or cylinders.
- If compressors or compressor oils are to be removed, make sure that they have been evacuated to an acceptable level to ensure that flammable refrigerant does not remain in the lubricant.
- The evacuation process shall be performed before sending the compressor to the suppliers.
- Only the electrical heating of the compressor body is allowed to accelerate the process.
- Oil shall be drained safely from the system.
- For installation with handling the refrigerant (R-32), use dedicated tools and piping materials. Because the pressure of the refrigerant, R-32, is approximately 1.6 times higher than that of R-22, failure to use the dedicated tools and piping materials may cause rupture or injury. Furthermore, it may cause serious accidents such as water leakage, electric shock, or fire.
- Never install motor-driven equipment to prevent ignition.
- Verify that the voltage and frequency of the power supply comply with the specifications and that the installed power is sufficient to ensure the operation of any other domestic appliance connected to the same electric lines.
- Always verify that the cut-off and protection switches are suitably dimensioned.
- Verify that the air conditioner is connected to the power supply following the instructions provided in the wiring diagram included in the manual.
- Always verify that electric connections (cable entry, section of leads, protections...) are compliant with the electric specifications and with the instructions provided in the wiring scheme. Always verify that all connections comply with the standards applicable to the installation of air conditioners.
- Devices disconnected from the power supply should be completely disconnected in the condition of overvoltage category.
- Be sure not to perform power cable modification, extension wiring, and multiple wire connections.
 - It may cause electric shock or fire due to poor connection, poor insulation, or current limit override.

Power supply line, fuse or circuit breaker

WARNING

- Always make sure that the power supply is compliant with current safety standards. Always install the air conditioner in compliance with current local safety standards.
- Always verify that a suitable grounding connection is available.

Precautions for using R-32 refrigerant

General

- This product is pre-charged with mildly flammable gas classified as A2L by ASHRAE. The following precautions and instruction manuals must be followed during installation, operation, servicing and decommissioning of the product.
- The appliance shall be stored in a room without continuously operating ignition sources, like open flames or a gas appliance or an electric heater.
- All national and local regulations shall be observed at all times.

- All pipe-work including piping material, pipe routing and installation shall include protection from physical damage in operation and service, and be in compliance with national and local codes and standards, such as ASHRAE 15, ASHRAE 15.2, IAPMO Uniform Mechanical Code, ICC International Mechanical Code, or CSA B52. All field joints shall be accessible for inspection prior to being covered or enclosed.
- All field piping and joints shall be pressure tested with an inert gas according to prevalent industry standards prior to refrigerant charging and system commissioning.
- Where additional field charging is required. The installer shall write with a permanent marker the field charge added on the ODU label provided, such that the Total Charge = Factory 'Pre-charge' + field charge.
- For ducted systems, any auxiliary systems that are potential ignition sources shall not be installed in the duct work. Examples of ignition sources are hot surfaces with temperatures exceeding 700°C and electric switching devices.
- Any auxiliary device installed must be approved by Samsung and must be suitable for operating with the refrigerant marked on the label.
- For mechanical ventilation the lower edge of the air extraction opening shall not be more than 100mm above the floor. The exhaust location outside the building must be at least 3 m away from the building opening and mechanical air intake openings.
- To handle, purge, and dispose of the refrigerant, or break into the refrigerant circuit, the worker should have a certificate from an industry-accredited authority.
- Non-ducted systems may be installed in areas such as false ceilings not being used as return air plenum if the conditioned air does not mix with the air in the false ceilings.
- For ducted appliances false ceiling or drop ceilings may be used as return air plenum if a refrigerant leak detection system is provided in the system and any external connections are also provided with a sensor immediately below the return air plenum duct joint.
- Installation, servicing and any type of maintenance or repair must be performed by certified personnel that are competent to carry out such activity in accordance with national and local regulations.

General Information on Servicing

- Do not work in a confined space. Ensure adequate ventilation is provided at the workspace during the entirety of the duration of the work to safely disperse any released refrigerant.
- All maintenance staff and others working in the local area shall be instructed on the nature of the work being performed and instructed to follow all instructions provided by Samsung, national and local authorities.
- The area shall be checked with an approved refrigerant detector before and during any work on the system.
- Have a dry CO₂ fire extinguisher adjacent to the charging area and workspace.
- The service personnel shall not use any ignition sources in a manner that may lead to the risk of fire or explosion.
- Potential ignition sources shall be kept away from the work area where the flammable refrigerant can be released into the surrounding area.
- The work area should be checked to ensure that there are no flammable hazards or ignition risks. The "No Smoking" sign shall be attached.
- Under no circumstances shall potential sources of ignition be used upon detection of leakage.

Safety Information

The following checks shall be applied to installations and maintenance operations.

- The actual total refrigerant charge is in accordance with the room size in accordance with Table 1.
- The ventilation machinery and outlets are operating adequately and are not obstructed.
- Markings on the equipment are visible and legible.
- Refrigerant pipes or components are installed in a position where they are unlikely to be exposed to any substance that may corrode refrigerant-containing components.

Initial checks of electrical devices shall include the following.

- that capacitors are discharged in a safe manner to avoid sparking.
- that no live electrical components and wiring are exposed while charging, recovering or purging the system.
- That there is continuity to earth bonding.
- Check that the cabling is not worn, corroded or damaged in any manner.

Electrical repair safety measures

- All electrical components used or replaced must be to Samsung's specifications.
- If a fault exists that could compromise safety, then no electrical supply shall be connected to the circuit until it is satisfactorily dealt with.
- Sealed electrical components and intrinsically safe components shall be replaced and not repaired.
- Cabling should be protected from excessive vibration, pressure, sharp edges, and other adverse environmental factors.

Detection of flammable refrigerants

- Electronic leak detectors shall be used to detect flammable refrigerants, but the sensitivity may not be adequate or may need re-calibration. (Detection equipment shall be calibrated in a refrigerant-free area.)
- Make sure that the detector is not a potential source of ignition.
- Leak detection equipment shall be set at a percentage of the LFL (Lower flammable limit) of the refrigerant and shall be calibrated to the refrigerant employed and the appropriate percentage of gas (25% maximum) is confirmed.
- The use of detergents containing chlorine shall be avoided for cleaning because the chlorine may react with the refrigerant and corrode the piping.
- If leakage is suspected, naked flames shall be removed.
- If a leakage is found while brazing, the entire refrigerant shall be recovered from the product or isolated (e.g. using shut-off valves). It shall not be directly released into the environment. Oxygen-free nitrogen (OFN) shall be used for purging the system before and during the brazing process.
- The work area shall be checked with an appropriate refrigerant detector before and during work.
- Ensure that the leakage detector is appropriate for use with flammable refrigerants.

Removal and Evacuation

- When removing refrigerant for servicing it is recommended to remove the entire quantity.
- When removing refrigerant follow local and national regulations and follow best practices including;
 - evacuate;
 - purge the circuit with inert gas (optional for A2L);
 - evacuate (optional for A2L);
 - continuously flush or purge with inert gas when using a flame to open the circuit; and
 - open the circuit.

-
- Use proper recovery cylinders appropriate for the type of refrigerant.
 - Follow prescribed industry best practices for purging and evacuation.
 - Oxygen free nitrogen shall be used for purging the system.

Charging procedure

- Follow industry standard refrigerant charging best practices.
- Before recharging the system, it shall be pressure tested with oxygen-free nitrogen gas.
- Ensure that contamination of different refrigerants does not occur when charging.
- Cylinders shall be kept in the appropriate position as per instructions.
- The refrigerant system should be grounded before charging the system.
- Label the system when charging is completed.
- Take extreme care not to overfill the refrigeration system.
- The system shall be leak tested on completion of charging before commissioning.

Decommissioning

- Only qualified licensed professionals shall perform refrigerant recovery and decommissioning.
- Isolate the system electrically.
- All recovery equipment and cylinders shall conform to appropriate standards. Only approved cylinders, with pressure relief valves, for the type of refrigerant shall be used.
- Recover refrigerant following industry standard procedure for flammable refrigerants.
- When draining compressors oil care must be taken that there is no flammable refrigerant in the compressor and that the compressor is not hot. Oil should be handled according to local and federal regulations.
- After decommissioning, the system shall be labeled stating that it has been decommissioned. The label shall be dated and signed. The label should state that it "contains flammable refrigerant".
- Ensure that there are labels on the equipment indicating the equipment contains flammable refrigerant.
- Recovered refrigerant shall not be mixed or reused. It shall be processed according to national, state and local regulations.

Installation Procedure

Step 1 Choosing the installation location

⚠ WARNING

- If appliances contain R-32 refrigerant, then the floor area of the room in which the appliances are installed, operated and stored must be larger than the minimum floor area defined in the table below A, [ft²(m²)].

<Table 1>

m [lbs(kg)]	Minimum required room area [A, ft ² (m ²)]			
	Reference Height [h ₀ , ft(m)]			
	Ceiling-mounted(without R-32 sensor)			
	7.2(2.2)	8.2(2.5)	8.9(2.7)	10.5(3.2)
≤ 4.047(1.836)	- no room area restrictions -			
4.049(1.837)	58.7(5.46)	51.7(4.80)	47.9(4.45)	40.4(3.75)
4.18(1.9)	60.8(5.64)	53.5(4.97)	49.5(4.60)	41.8(3.88)
4.40(2.0)	64.0(5.94)	56.3(5.23)	52.1(4.84)	44.0(4.08)
4.85(2.2)	70.4(6.54)	61.9(5.75)	57.3(5.33)	48.4(4.49)
5.29(2.4)	76.7(7.13)	67.5(6.27)	62.5(5.81)	52.8(4.90)
5.73(2.6)	83.1(7.72)	73.2(6.80)	67.7(6.29)	57.2(5.31)
6.17(2.8)	89.5(8.32)	78.8(7.32)	73.0(6.78)	61.6(5.72)
6.61(3.0)	95.9(8.91)	84.4(7.84)	78.2(7.26)	66.0(6.13)
7.05(3.2)	102(9.51)	90.1(8.37)	83.4(7.75)	70.4(6.54)
7.49(3.4)	109(10.1)	95.7(8.89)	88.6(8.23)	74.7(6.94)
7.93(3.6)	115(10.7)	101(9.41)	93.8(8.71)	79.1(7.35)
8.37(3.8)	122(11.3)	107(9.93)	99.0(9.20)	83.5(7.76)
8.81(4.0)	128(11.9)	113(10.5)	104(9.68)	87.9(8.17)
9.25(4.2)	134(12.5)	118(11.0)	109(10.2)	92.3(8.58)
9.70(4.4)	141(13.1)	124(11.5)	115(10.7)	96.7(8.99)
10.14(4.6)	147(13.7)	129(12.0)	120(11.1)	101(9.40)
10.58(4.8)	158(14.7)	135(12.5)	125(11.6)	106(9.80)
11.02(5.0)	172(16.0)	141(13.1)	130(12.1)	110(10.2)
11.46(5.2)	186(17.3)	146(13.6)	135(12.6)	114(10.6)
11.90(5.4)	200(18.6)	155(14.4)	141(13.1)	119(11.0)
12.34(5.6)	215(20.0)	167(15.5)	146(13.6)	123(11.4)
12.78(5.8)	231(21.5)	179(16.6)	153(14.3)	128(11.8)
13.22(6.0)	247(23.0)	192(17.8)	164(15.3)	132(12.3)

m [lbs(kg)]	Minimum required room area [A, ft ² (m ²)]			
	Reference Height [h ₀ , ft(m)]			
	Ceiling-mounted(with R-32 sensor)			
	7.2(2.2)	8.2(2.5)	8.9(2.7)	10.5(3.2)
≤ 4.047(1.836)	- no room area restrictions -			
4.049(1.837)	58.7(5.46)	51.7(4.80)	47.9(4.45)	40.4(3.75)
4.18(1.9)	60.8(5.64)	53.5(4.97)	49.5(4.60)	41.8(3.88)
4.40(2.0)	64.0(5.94)	56.3(5.23)	52.1(4.84)	44.0(4.08)
4.85(2.2)	70.4(6.54)	61.9(5.75)	57.3(5.33)	48.4(4.49)
5.29(2.4)	76.7(7.13)	67.5(6.27)	62.5(5.81)	52.8(4.90)
5.73(2.6)	83.1(7.72)	73.2(6.80)	67.7(6.29)	57.2(5.31)
6.17(2.8)	89.5(8.32)	78.8(7.32)	73.0(6.78)	61.6(5.72)
6.61(3.0)	95.9(8.91)	84.4(7.84)	78.2(7.26)	66.0(6.13)
7.05(3.2)	102(9.51)	90.1(8.37)	83.4(7.75)	70.4(6.54)
7.49(3.4)	109(10.1)	95.7(8.89)	88.6(8.23)	74.7(6.94)
7.93(3.6)	115(10.7)	101(9.41)	93.8(8.71)	79.1(7.35)
8.37(3.8)	122(11.3)	107(9.93)	99.0(9.20)	83.5(7.76)
8.81(4.0)	128(11.9)	113(10.5)	104(9.68)	87.9(8.17)
9.25(4.2)	134(12.5)	118(11.0)	109(10.2)	92.3(8.58)
9.70(4.4)	141(13.1)	124(11.5)	115(10.7)	96.7(8.99)
10.14(4.6)	147(13.7)	129(12.0)	120(11.1)	101(9.40)
10.58(4.8)	153(14.3)	135(12.6)	125(11.6)	106(9.80)
11.02(5.0)	160(14.9)	141(13.1)	130(12.1)	110(10.2)
11.46(5.2)	166(15.5)	146(13.6)	135(12.6)	114(10.6)
11.90(5.4)	173(16.0)	152(14.1)	141(13.1)	119(11.0)
12.34(5.6)	179(16.6)	158(14.6)	146(13.6)	123(11.4)
12.78(5.8)	185(17.2)	163(15.2)	151(14.0)	128(11.9)
13.22(6.0)	192(17.8)	169(15.7)	156(14.5)	132(12.3)

m [lbs(kg)]	Minimum required room area [A, ft ² (m ²)]	
	Reference Height [h ₀ , ft(m)]	
	Wall-mounted	¹⁾ Floor-standing
≤ 4.047(1.836)	- no room area restrictions -	
4.049(1.837)	71.8(6.67)	215(20.0)
4.18(1.9)	74.3(6.90)	223(20.7)
4.40(2.0)	78.2(7.26)	235(21.8)
4.85(2.2)	86.0(7.99)	258(24.0)
5.29(2.4)	93.8(8.71)	281(26.1)
5.73(2.6)	102(9.44)	305(28.3)
6.17(2.8)	109(10.2)	328(30.5)
6.61(3.0)	117(10.9)	352(32.7)
7.05(3.2)	125(11.6)	375(34.9)
7.49(3.4)	133(12.3)	399(37.0)
7.93(3.6)	141(13.1)	422(39.2)
8.37(3.8)	149(13.8)	446(41.4)
8.81(4.0)	164(15.3)	469(43.6)
9.25(4.2)	181(16.8)	492(45.8)
9.70(4.4)	199(18.5)	516(47.9)
10.14(4.6)	217(20.2)	539(50.1)
10.58(4.8)	236(22.0)	563(52.3)
11.02(5.0)	257(23.8)	586(54.5)
11.46(5.2)	277(25.8)	610(56.6)
11.90(5.4)	299(27.8)	633(58.8)
12.34(5.6)	322(29.9)	657(61.0)
12.78(5.8)	345(32.1)	680(63.2)
13.22(6.0)	369(34.3)	704(65.4)

- m : Total refrigerant charge in the system
- A : Minimum required room area
- Calculated in accordance with UL 60335-2-40 Annex GG
- The actual refrigerant charge shall be per the room size within which the refrigerant-containing parts are installed.

¹⁾ For models with R-32 sensor

- The ventilation machinery and outlets shall be operating adequately and not obstructed.
- If an indirect refrigerating circuit is being used, the secondary circuit shall be checked for the presence of refrigerant.
- Marking the equipment shall continue to be visible and legible. Markings and signs that are illegible shall be corrected.
- Refrigerating pipe or components shall be installed in a position where they are unlikely to be exposed to any substance that may corrode refrigerant-containing components unless the components are constructed of materials that are inherently resistant to being corroded or are suitably protected against being so corroded.
- **IMPORTANT:** It's mandatory to either follow the table above or follow the federal, state, and/or local regulations regarding the minimum room area allowed for the total refrigerant charge in the system.
- Minimum installation height depends on indoor unit specifications. Please refer to the indoor unit installation manual.

Installation location requirements

- The outdoor unit shall be installed in an open space that is always ventilated.
- All national, state, and local codes and regulations shall be observed.
- For installation inside a building (this applies either to indoor or outdoor units installed inside) a minimum room floor area of space conditioned is mandatory according to EN378-1:2017 (see the reference table in the indoor unit installation manual).
- To handle, purge, and dispose of the refrigerant, or to break into the refrigerant circuit, the technician should have a certificate from an industry-accredited authority.

Installation Procedure

- Do not install the air conditioner in the following areas.
 - The place where there is mineral oil or arsenic acid. Resin parts flame and the accessories may drop or water may leak. The capacity of the heat exchanger may reduce or the air conditioner may be out of order.
 - The place where corrosive gas such as sulfurous acid gas is generated from the vent pipe or air outlet. The copper pipe or connection pipe may corrode, and the refrigerant may leak.
 - The place where there is a machine that generates electromagnetic waves. The air conditioner may not operate normally due to the control system.
 - The place where there is a danger of existing combustible gas, carbon fiber or flammable dust.
 - The place where animals may urinate on the product. Ammonia may be generated.
 - The place where thinner or gasoline is handled. Gas may leak and it may cause fire.
 - The place that is close to heat sources.
- Do not use the indoor unit for the preservation of food items, plants, equipment, and artwork. This may cause deterioration of their quality.
- Do not install the indoor unit if it has any drainage problems.
- Do not place the outdoor unit on its side or upside down. Failing to do so may cause the compressor lubrication oil to run into the cooling circuit and lead to serious damage to the unit.
- Install the unit in a well-ventilated location away from direct sunlight or strong winds.
- Install the unit in a location that would not obstruct any passageways or thoroughfares.
- Install the unit in a location that would not inconvenience or disturb your neighbors, as they could be affected by the noise or the airflow coming from the unit.
- Install the unit in a location where the pipes and the cables can be easily connected to the indoor unit.
- Install the unit on a flat, stable surface that can withstand the weight of the unit. Otherwise, the unit can generate noise and vibration during operation.

- Install the unit so that the air flow is directed towards the open area.
- Maintain sufficient clearance around the outdoor unit, especially from a radio, computer, stereo system, etc.

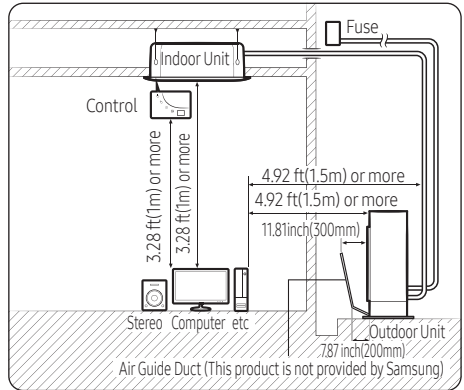

- Install the unit at a height where its base can be firmly fixed in place.
- Make sure that the water dripping from the drain hose runs away correctly and safely.

⚠ CAUTION

- You have just purchased a system air conditioner and it has been installed by your installation specialist.
- This device must be installed according to the national electrical codes.
- If your outdoor unit exceeds a net weight of 132.2 lbs(60 kg), do not install it on a suspended wall, but stand it on the floor.
- The reliability of our product cannot be guaranteed when the ambient temperature is less than "A".

Outdoor Model	"A"
AC***DXSCCG	-13°F(-25°C)
AC***DXADCG	-4°F(-20°C)
AC***DXSCCF	-40°F(-40°C)

- If you operate the cooling operation of the air conditioner in the condition where the ambient temperature is lower than 23 °F(-5°C) DB(Dry bulb), or the outdoor unit might be faced with strong wind directly, the wind baffle should be installed to prevent the outdoor unit fan from operating in reverse way.
- If the indoor unit is installed in an IT room (for example, a computer room), a separate backup system must be installed.
- When installing the outdoor unit at the seaside, make sure that it is not directly exposed to sea breeze. If you cannot find an adequate place free from direct sea breeze, construct a protection wall or a protective fence.
 - Install the outdoor unit in a place (such as near buildings etc.) where it can be protected from sea breeze. Failure to do so may cause damage to the outdoor unit.

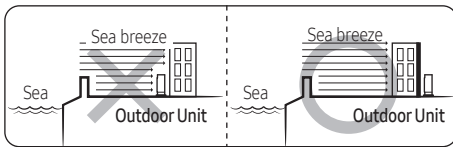

- If you cannot avoid installing the outdoor unit at the seaside, construct a protection wall around it to block the sea breeze.
- Construct a protection wall with a solid material such as concrete to block the sea breeze. Make sure that the height and the width of the wall are 1.5 times larger than the size of the outdoor unit. Also, secure a space larger than 27.6 inches(700mm) between the protection wall and the outdoor unit for exhausted air to ventilate.

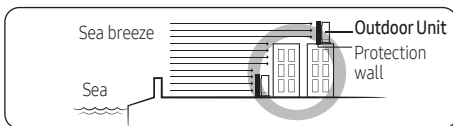

⚠ CAUTION

- Depending on the condition of the power supply, unstable power or voltage may cause malfunction of parts or control systems (for example : on a boat or places using power supplied from an electric generator, etc.).
- Install the unit in a place where water can drain smoothly.
- If you have any difficulty finding the installation location as prescribed above, contact your manufacturer for details.
- Consider that the salinity particles clinging to the external panels should be sufficiently washed out. Be sure to clean seawater and dust from the outdoor unit heat exchanger and apply a corrosion inhibitor on it at least once a year.
- Because the residual water at the bottom of the outdoor unit significantly promotes corrosion, make sure that the slope does not disturb drainage.
 - Keep the floor level so that rain does not accumulate.
 - Be careful not to block the drain hole due to foreign substances.
- Be sure to clean the heat exchanger and base plate of the outdoor unit regularly from any collected sand and salt.
- Touch up the additional protective coating (third party) if needed, at least once a year or according to the third party's product requirements

Installation Procedure

- Check the condition of the product periodically.
 - Check the installation site every 3 months and perform anti-corrosion treatment such as R-Pro supplied by SAMSUNG (Code : MOK-220SA) or commercial water repellent grease and wax, etc., based on the product condition.
 - When the product is to be shut down for a long time, such as off-peak hours, take appropriate measures like covering the product.
- If the product is installed within 1640.4 ft (500 m) of the seashore, a special anti-corrosion treatment is required.
 - ※ Please contact your local SAMSUNG representative for further details.

⚠ CAUTION

- In areas with heavy snowfall, piled snow could block the air intake. To avoid this incident, install a frame that is higher than the estimated snowfall. In addition, install a snow-proof hood to prevent snow from piling on the outdoor unit.

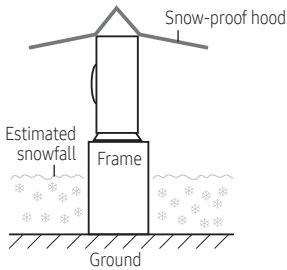

Outdoor unit dimensions

Unit : inch (mm)

A Type	
AC018DXSCCG, AC024DXADCG, AC024DXSCCF	
B Type	
AC024DXSCCG, AC030/036DXADCG, AC030/036DXSCCF	
C Type	
AC048DXADCG	
D Type	
AC030/036/048DXSCCG	

Minimum clearances for the outdoor unit

When installing 1 outdoor unit

Unit : inch (mm)

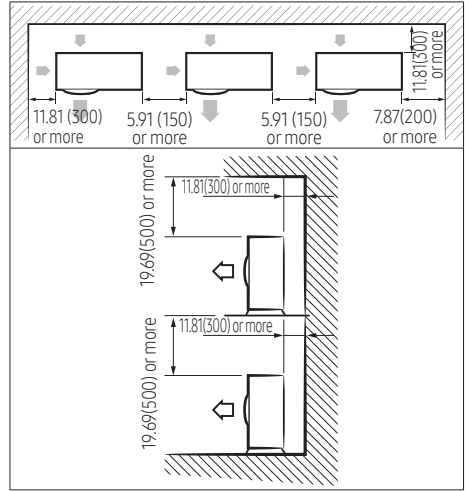
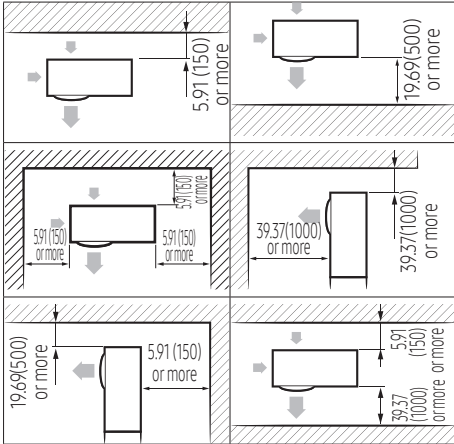

When installing more than 1 outdoor unit

Unit : inch (mm)

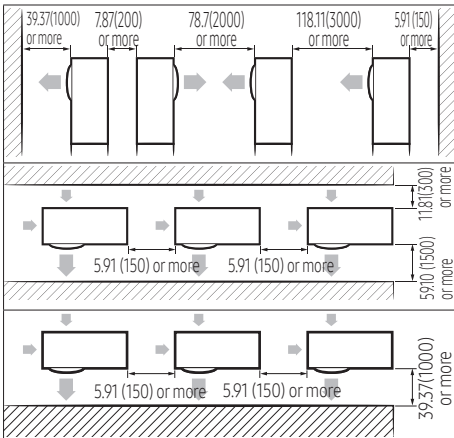

⚠ CAUTION

- The outdoor unit must be installed according to the specified clearance distances to permit accessibility from each side, and to guarantee correct operation, maintenance, and repair of the unit.

The components of the outdoor unit must be accessible and removable under safe conditions for people and the unit.

⚠ WARNING

- Should adopt bar type louver. Don't use a type of rain resistance louver.

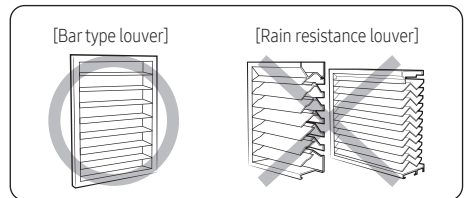

- Louver specifications.
 - Angle criteria : less than 20°
 - Opening ratio criteria : greater than 80%



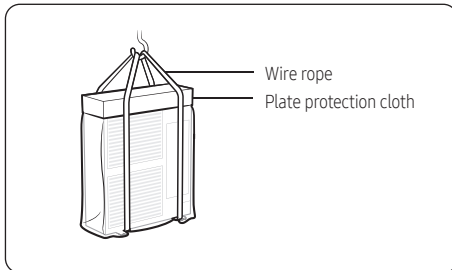
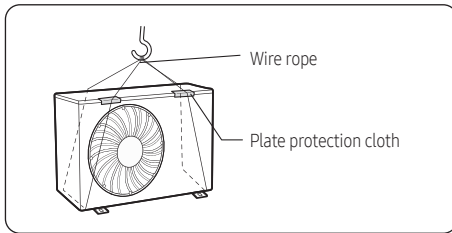

Installation Procedure

Moving the outdoor unit with wire rope

- 1 Before carrying the outdoor unit, fasten two wire ropes of 26.25 ft (8m) or longer, as shown in the figure.
- 2 To prevent damage or scratches effectively, insert a piece of cloth between the outdoor unit and the ropes.
- 3 Move the outdoor unit.



Step 2 Checking and preparing accessories and tools

Drain Plug (1) ¹⁾	Energy Label (1)
	
Rubber Leg (4)	Installation Manual (1)
	
Drain Cap (3) ¹⁾	
	

¹⁾ Not included for models:
AC024/030/036DXSCCF

NOTE

- Wire assembly cables are optional. If they are not supplied, use standard cables.
- The drain plugs and the rubber legs are included only when the air conditioner is supplied without assembly pipes.
- If these accessories are supplied, they are in the accessory package or outdoor unit package.

Step 3 Fixing the outdoor unit in place

Install the outdoor unit on a rigid and stable base to prevent disturbance from any noise caused by vibration. When installing the unit on tall stands or in a location exposed to strong winds, fix the unit securely to the ground or structure.

- Position the outdoor unit so that the air flow is directed towards the outside, as indicated by the arrows on the top of the unit.
 - Attach the outdoor unit to the appropriate support using anchor bolts.
- The ground wire for the telephone line cannot be used to ground the air conditioner.
- If the outdoor unit is exposed to strong winds, install shield plates around the outdoor unit, so that the fan can operate correctly.

NOTE

- Install provided rubber legs to prevent vibration and noise.

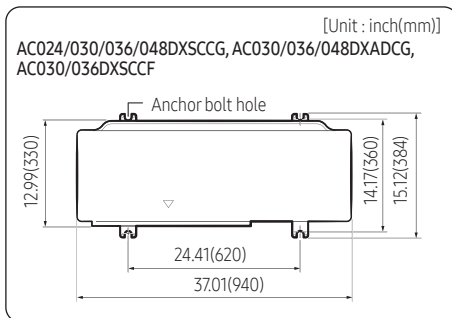
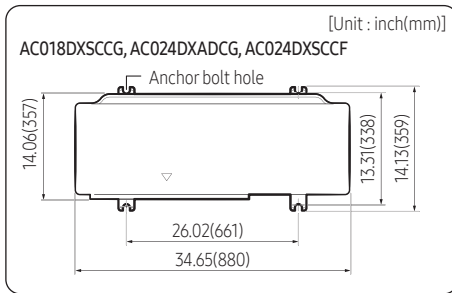

CAUTION

- Install a drain outlet at the lowest end around the base for outdoor unit drainage.
- When installing the outdoor unit on the roof, waterproof the unit and check the ceiling strength.

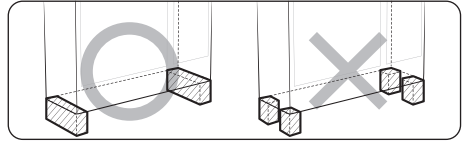

Optional: Fixing the outdoor unit to a wall with a rack

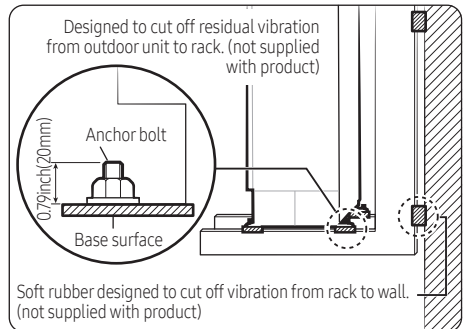

- Install a proper grommet to reduce noise and residual vibration transferred by the outdoor unit towards the wall.

CAUTION

- Make sure that the wall can support the weights of the rack and the outdoor unit.
- Install the rack as close to the column as possible.
- When installing an air guide duct, be sure to check the following:
 - The screws do not damage the copper pipe.
 - The air guide duct is fixed firmly on the guard fan.

Installation Procedure

Step 4 Connecting the power cables, communication cable, and controllers

You must connect the following three electrical cables to the outdoor unit:

- The main power cable between the auxiliary circuit breaker and the outdoor unit.
- The outdoor-to-indoor power cable between the outdoor unit and the indoor unit.
- The communication cable between the outdoor unit and the indoor unit.

⚠ CAUTION

- During installation, first make the refrigerant connections and then the electrical connections. If the unit is being removed, first disconnect the electrical cables and then the refrigerant connections.
- Connect the air conditioner to the earthing system before making the electrical connections.

Connecting wire conduits

When connecting the power supply cables and communication cable, use conduits to protect the cables.

- 1 Drill holes on the conduit plate per their use and quantity.
 - AC018DXSCCG, AC024DXADCG, AC024DXSCCF
 - Use snips to remove the conduit hole knockouts on the side cabinet. (knock out holes)

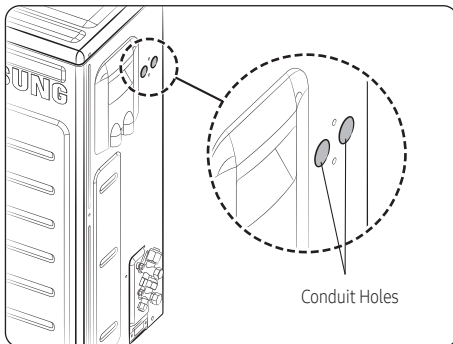

- AC024/030/036/048DXSCCG, AC030/036/048DXADCG, AC030/036DXSCCF
 - Use a nipper to remove conduit holes from the lower part of the cabinet. (Do not remove it by hammering.)

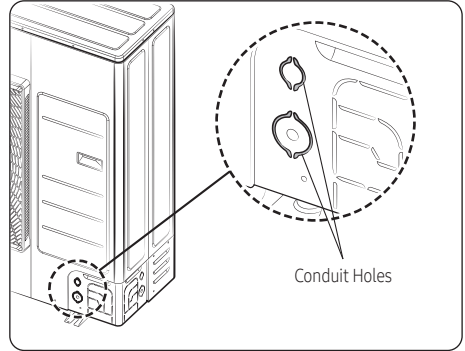

- 2 Insert the cables through the conduits, and then fix the conduits to the conduit plate with the lock nuts.
- 3 Apply silicone to the end of the hose to prevent rain from entering the hose.

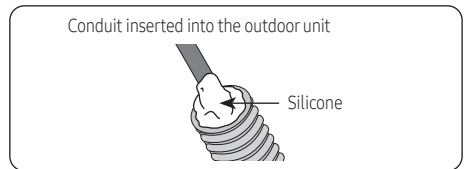

- 4 Connect the cables to the outdoor units. For how to connect the cables, refer to the next page.
- 5 Attach the conduit plate to the product.

Air conditioning system examples

When using an earth leakage circuit breaker (ELCB) for a single phase unit.

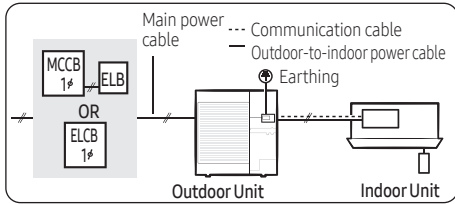

※ The appearance of the unit may be different from the picture depending on the model.

⚠ CAUTION

- Make sure to install an ELCB (RCD or RCCB) or ELB and MCB combination, according to local regulations.
- If the outdoor unit is installed in a location vulnerable to an electric leak or submergence, make sure to install an ELCB.
- AC018/024/030/036/048DXSCCG: ELCB must be installed since this product is equipped with a base heater.
- This product uses the R-32 refrigerant, be cautious not to generate any sparks near the product.

Connecting the main power cable

When using ELB for AC018DXSCCG, AC024DXADCG, AC024DXSCCF (1-phase)

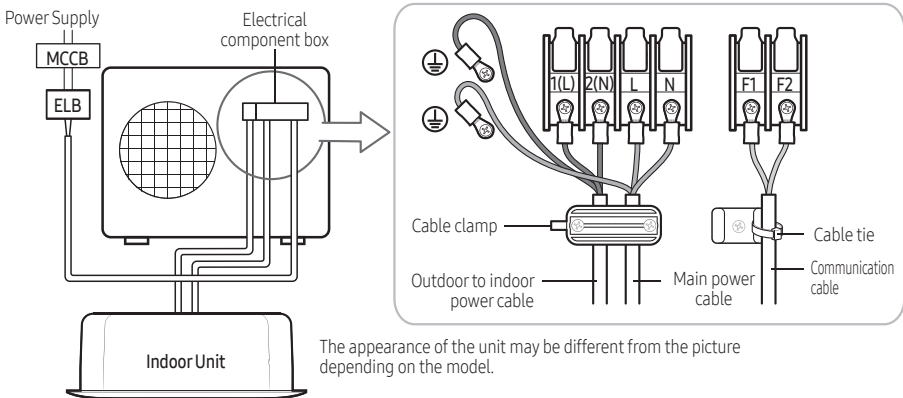

The appearance of the unit may be different from the picture depending on the model.

Installation Procedure

When using ELB for AC024/030/036/048DXSCCG, AC030/036/048DXADCG, AC030/036DXSCCF (1-phase)

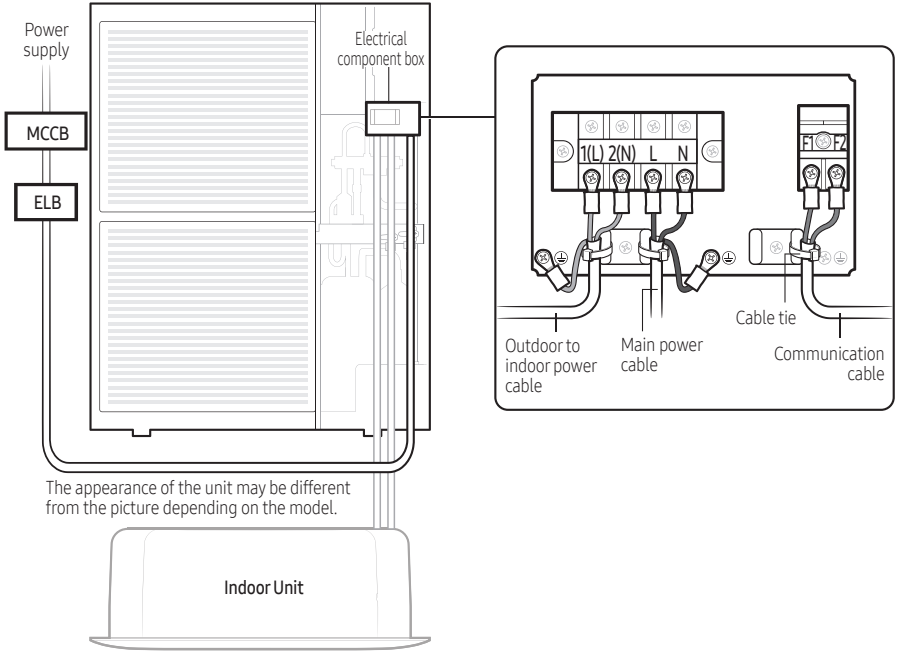

⚠ CAUTION

- You should connect the power cable to the power cable terminal and fasten it with a clamp.
- To protect the product from water and possible shock, you should keep the power cable and the connection cord of the indoor and outdoor units within ducts. (with appropriate IP rating and material selection for your application)
- Ensure that the main supply connection is made through a switch that disconnects all poles, with a contact gap of a least 0.12 inches(3mm).
- Devices disconnected from the power supply should be completely disconnected in the condition of overvoltage category.
- Keep distances of 1.97 inches(50 mm) or more between the power cable and communication cable. If a distance of 1.97 inches(50 mm) or more cannot be kept, a double shielded cable (FROHH2R or LiYCY type) must be used, connected to the earth on a single side.

Main power terminal block specifications

[Unit : inch(mm)]

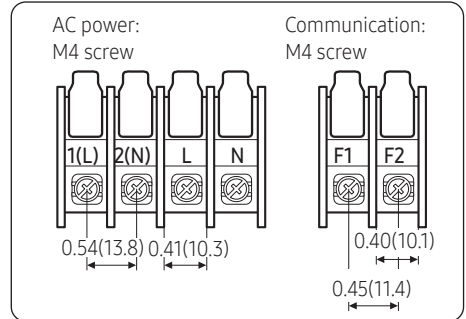

Main power cable specifications

The power cable is not supplied with the air conditioner.

- Select the power supply cable following relevant local and national regulations.
- Wire size must comply with the applicable local and national codes.
- Specifications for local power cord wiring and branch wiring must comply with local codes.

Installation Procedure

Model		Power Source	RLA (A)	Outdoor		Indoor	MCA (A)	MOP (A)
Outdoor	Indoor			MOC		Rated input current of the power conversion equipment		
				FAN1(A)	FAN2(A)	FAN(A)		
AC018DXSCCG	AC018DNLDCG	208-230V/ 60Hz	14.1	1.20	-	1.06	22.7	25.0
	AC018DNHDCG					2.10		
	AC018DNJDCG					0.49		
	AC018DNADCG					0.42		
	AC018DN1DCG					0.42		
	AC018DNNDCG					0.30		
	AC018DN4DCG					0.79		
	AC018DN6DCG					0.79		
	AC018DNZDCG					3.01		
AC024DXADCG	AC024DN4DCG		14.4	1.20	-	0.79	22.3	25.0
	AC024DNHDCG					2.10		
	AC024DNZDCG					3.01		
AC024DXSCCF	AC024DN4DCG		14.8	0.97	-	0.79	21.3	25.0
	AC024DNHDCG					2.10		
	AC024DNADCG					0.42		
AC024DXSCCG	AC024DNHDCG	17.3	1.20	-	2.10	26.7	30.0	
	AC024DNADCG				0.42			
	AC024DN4DCG				0.79			
	AC024DN6DCG				0.79			
	AC024DNZDCG				3.01			
AC030DXADCG	AC030DN4DCG	17.6	1.20	-	0.79	26.7	30.0	
	AC030DNHDCG				3.50			
	AC030DNZDCG				3.01			

Model		Power Source	RLA (A)	Outdoor		Indoor	MCA (A)	MOP (A)
Outdoor	Indoor			MOC		Rated input current of the power conversion equipment		
				FAN1(A)	FAN2(A)	FAN(A)		
AC030DXSCCF	AC030DN4DCG	208~230V/ 60Hz	17.9	0.97	-	0.79	27.0	30.0
	AC030DNHDCG					3.50		
	AC030DNTDCG					0.51		
AC030DXSCCG	AC030DNHDCG		22.6	1.20	1.20	3.50	35.0	40.0
	AC030DNTDCG					0.51		
	AC030DN4DCG					0.79		
	AC030DN6DCG					0.79		
	AC030DNZDCG					3.01		
AC036DXADCG	AC036DN4DCG		17.6	1.20	-	0.79	26.7	30.0
	AC036DNHDCG					3.50		
	AC036DNZDCG					4.33		
AC036DXSCCF	AC036DN4DCG		17.9	0.97	-	0.79	27.0	30.0
	AC036DNHDCG					3.50		
	AC036DNTDCG					0.51		
AC036DXSCCG	AC036DNHDCG		22.6	1.20	1.20	3.50	35.8	40.0
	AC036DNTDCG					0.51		
	AC036DN4DCG					0.79		
	AC036DN6DCG					0.79		
	AC036DNZDCG	4.33						
AC048DXADCG	AC048DN4DCG	23.0	1.20	1.20	0.79	36.1	40.0	
	AC048DNHDCG				3.50			
	AC048DNZDCG				4.94			
AC048DXSCCG	AC048DNHDCG/AA	22.4	1.20	1.20	3.50	36.2	40.0	
	AC048DN4DCG/AA				0.79			
	AC048DN6DCG/AA				0.79			
	AC048DNZDCG/AA				4.94			

Installation Procedure

NOTE

- RLA is based on AHRI 210/240 cooling standard condition [Indoor temp. : 26.7 °C / 80 °F(DB) / 19.46 °C / 67 °F(WB), Outdoor temp. : 35 °C / 95 °F(DB)]
- Voltage tolerance is $\pm 10 \%$.
- Symbols
 - RLA: Rated Load Ampere (A)
 - MOC: Maximum Operating Current (A)
 - MCA: Minimum Circuit Ampacity (A)
 - MOP: Maximum Overcurrent Protection Device (A)
- Voltage range
 - Units are suitable for use on electrical systems where the voltage supplied to the unit terminal is not below or above listed range limits.
- Wire size & type must comply with the applicable local and national codes.
 - Wire size: Based on the value of MCA.
 - Wire type: 1-phase: 60245 IEC57(IEC) or H05RN-F(CENELEC) grade or more

Silence mode controller wiring diagram with External controller

- AC018DXSCCG, AC024DXADCG, AC024DXSCCF

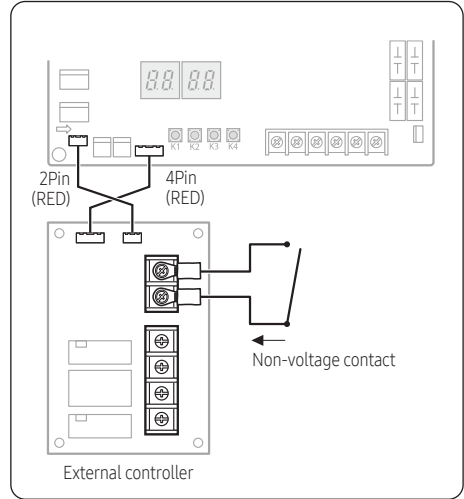

- AC024/030/036/048DXSCCG, AC030/036/048DXADCG, AC030/036DXSCCF

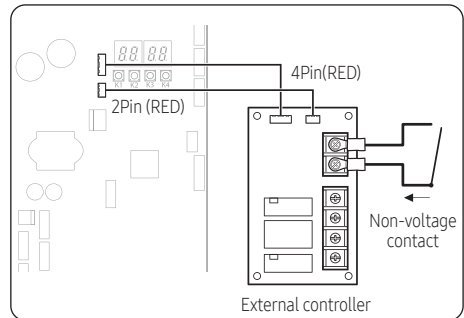

Connecting the outdoor-to-indoor power cable and the communication cable

- AC018DXSCCG, AC024DXADCG, AC024DXSCCF

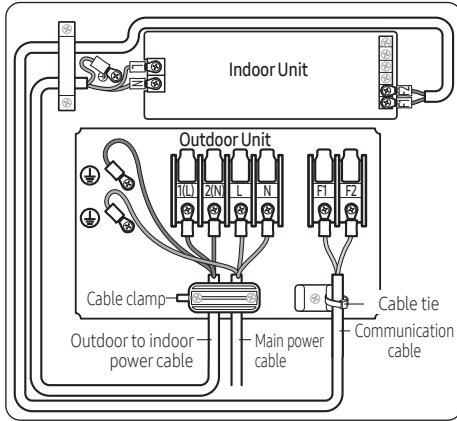

- AC024/030/036/048DXSCCG, AC030/036/048DXADCG, AC030/036DXSCCF

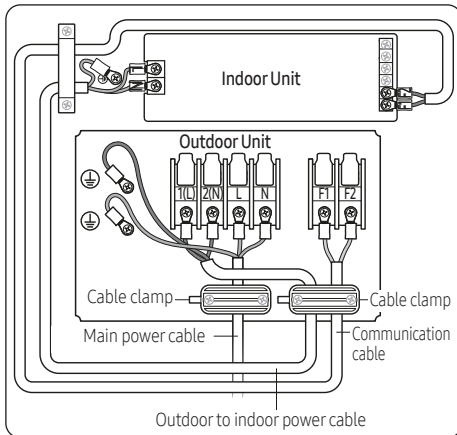

NOTE

- Lay the electrical wiring so that the front cover does not rise up when doing wiring work and attach the front cover securely.
- The ground wire for the indoor unit and outdoor unit connection cable must be clamped to a soft copper tin-plated eyelet terminal with M4 screw hole (NOT SUPPLIED WITH UNIT ACCESSORIES).
- The appearance of the unit may be different from the picture depending on the model.

Outdoor-to-indoor power terminal specifications

- Connect the cables to the terminal board using the compressed ring terminal.
- Cover a solderless ring terminal and a connector part of the power cable and then connect it.

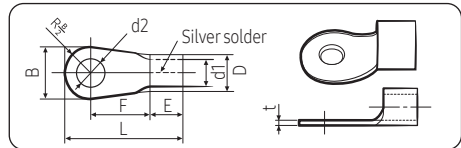

Installation Procedure

Nominal dimensions for cable [mm ² (inch ²)]	Nominal dimensions for screw [mm ² (inch ²)]	B		D		d1		E	F	L	d2		t
		Standard dimension [mm(inch)]	Allowance [mm(inch)]	Standard dimension [mm(inch)]	Allowance [mm(inch)]	Standard dimension [mm(inch)]	Allowance [mm(inch)]	Min. [mm (inch)]	Min. [mm (inch)]	Max. [mm (inch)]	Standard dimension [mm(inch)]	Allowance [mm(inch)]	Min. [mm (inch)]
4/6 (0.006/ 0.009)	4 (3/8)	9.5 (3/8)	±0.2 (±0.007)	5.6 (1/4)	+0.3(+0.011) -0.2(-0.007)	3.4(1/8)	±0.2 (±0.007)	6 (1/4)	5 (3/16)	20 (3/4)	4.3 (3/16)	+0.2 (+0.007) 0(0)	0.9 (0.03)
	8 (3/16)	15 (9/16)							9 (3/8)	28.5 (1-1/8)	8.4 (1-3/16)	+0.4(+0.015) 0(0)	
10 (0.01)	8 (3/16)	15 (9/16)	±0.2 (±0.007)	7.1 (1/4)	+0.3(+0.011) -0.2(-0.007)	4.5(3/16)	±0.2 (±0.007)	7.9 (5/16)	9 (3/8)	30 (1-3/16)	8.4 (1-3/16)	+0.4(+0.015) 0(0)	1.15 (0.04)
16 (0.02)	8 (3/16)	16 (10/16)	±0.2 (±0.007)	9 (3/8)	+0.3(+0.011) -0.2(-0.007)	5.8(1/4)	±0.2 (±0.007)	9.5 (5/16)	13 (1/2)	33 (1-5/16)	8.4 (1-3/16)	+0.4 (+0.015) 0(0)	1.45 (0.05)
25 (0.03)	8 (3/16)	12 (1/2)	±0.3 (±0.011)	11.5 (7/16)	+0.5(+0.019) -0.2(-0.007)	7.7(5/16)	±0.2 (±0.007)	11 (3/8)	15 (5/8)	34 (1-3/8)	8.4 (1-3/16)	+0.4 (+0.015) 0(0)	1.7 (0.06)
	8 (3/16)	16.5 (10/16)							13 (1/2)	45 (1-1/2)	8.4 (1-3/16)		
35 (0.05)	8 (3/16)	16 (10/16)	±0.3 (±0.011)	13.3 (1/2)	+0.5(+0.019) -0.2(-0.007)	9.4(3/8)	±0.2 (±0.007)	12.5 (1/2)	13 (1/2)	38 (1-1/2)	8.4 (1-3/16)	+0.4 (+0.015) 0(0)	1.8 (0.07)
	8 (3/16)	22 (7/8)							13 (1/2)	45 (1-1/2)	8.4 (1-3/16)		
50 (0.07)	8 (3/16)	22 (7/8)	±0.3 (±0.011)	13.5 (1/2)	+0.5(+0.019) -0.2(-0.007)	11.4(7/16)	±0.3 (±0.011)	17.5 (11/16)	14 (9/16)	50 (2)	8.4 (1-3/16)	+0.4 (+0.015) 0(0)	1.8 (0.07)
70 (0.10)	8 (3/16)	24 (1)	±0.4 (±0.015)	17.5 (11/16)	+0.5(+0.019) -0.4(-0.015)	13.3(1/2)	±0.4 (±0.015)	18.5 (3/4)	20 (3/4)	51 (2)	8.4 (1-3/16)	+0.4 (+0.015) 0(0)	2.0 (0.078)

- Connect the rated cables only.
- Connect using a driver which can apply the rated torque to the screws.
- If the terminal is loose, fire may occur caused by arc. If the terminal is connected too firmly, the terminal may be damaged.

⚠ CAUTION

- When connecting cables, you can connect the cables to the electrical part or connect them through the holes below depending on the spot.
- Connect the communication cable between the indoor and outdoor units through a conduit to protect against external forces, and feed the conduit through the wall together with refrigerant piping.
- Remove all burrs at the edge of the knock-out hole and secure the cable to the outdoor knock-out using lining and bushing with electrical insulation such as rubber and so on.
- Must keep the cable in a protection tube.
- Keep distances of 1.97 inch(50mm) or more between power cable and communication cable.
- When the cables are connected through the hole, remove the knock-out piece.

	Tightening torque	
	lbf•ft	N•m
M4	0.87 to 1.30	0.8 to 1.2
M5	1.45 to 2.17	2.0 to 3.0

Outdoor-to-indoor power and communication cable specifications

- Indoor unit :
 - 1-Way CST (AC***DN1DCG)
 - 4-Way CST (AC***DN4DCG)
 - 360 CST (AC***DN6DCG)
 - Mini 4-Way CST (AC***DNND CG)
 - Console (AC***DNJDCG)
 - High Wall (AC***DNTDCG, AC***DNADCG)
 - Slim Duct (AC***DNLDCG)

Indoor power supply		
Power supply	Max/Min (V)	Indoor power cable
1Φ, 208-230V~, 60Hz	±10%	AWG18↑, 3 wires
Communication cable		
AWG18↑, 2 wires		

- Indoor unit :
 - Duct S (AC***DNHDCG)
 - MPAHU (AC***DNZDCG)

Indoor power supply		
Power supply	Max/Min (V)	Indoor power cable
1Φ, 208-230V~, 60Hz	±10%	AWG14↑, 3 wires
Communication cable		
AWG18↑, 2 wires		

- Power supply cords of parts of appliances for outdoor use shall not be lighter than polychloroprene sheathed flexible cords. (Code designation IEC:60245 IEC 57 / CENELEC: H05RN-F)
- When installing the indoor unit in a computer room or network room, use the double shielded (tape aluminum / polyester braid + copper) cable of FROHH2R or LiYCY type.

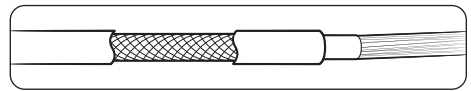

Installation Procedure

Step 5 Connecting the refrigerant pipe

Items	Maximum allowable length [ft (m)]	
Applicable outdoor unit models	Main pipe (L1)	Max. height difference between outdoor and indoor units (h1)
AC018DXSCCG AC024DXSCCG AC024DXADCG AC030DXADCG AC036DXADCG AC024DXSCCF AC030DXSCCF AC036DXSCCF	164.0(50)	98.4(30)
AC030DXSCCG AC036DXSCCG AC048DXSCCG AC048DXADCG	246.0(75)	98.4(30)

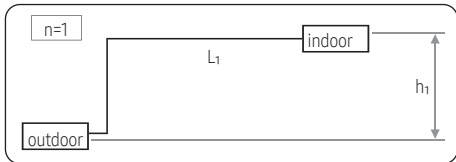

- Temper grade and minimum thickness of the refrigerant pipe

Outer diameter [inch(mm)]	Minimum thickness [inch(mm)]	Temper grade
ø1/4(6.35)	0.0276(0.7)	C1220T-O
ø3/8(9.52)	0.0276(0.7)	
ø1/2(12.7)	0.0315(0.8)	
ø5/8(15.88)	0.0394(1.0)	
ø5/8(15.88)	0.0315(0.8)	C1220T-1/2H OR C1220T-H
ø3/4(19.05)	0.0354(0.9)	
ø7/8(22.23)	0.0354(0.9)	

- The material specification (thickness) of the refrigerant pipes must follow national, state, and local regulations.

⚠ CAUTION

- Be sure to use C1220T-1/2H (Semi-hard) pipe for more than ø3/4 inch (19.09 mm). If you use a C1220T-O (Soft) pipe for ø3/4 inch (19.09 mm), the pipe may break, which can result in an injury.

AC018DXSCCG, AC024DXADCG, AC024DXSCCF

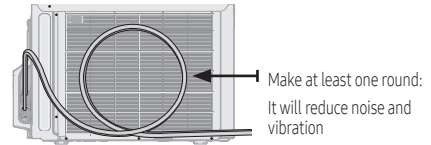

AC024/030/036/048DXSCCG, AC030/036/048DXADCG, AC030/036DXSCCF

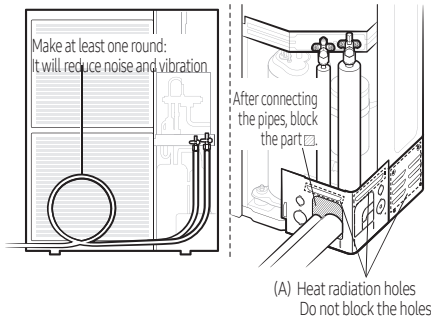

- The designs and shapes are subject to change according to the model.

⚠ CAUTION

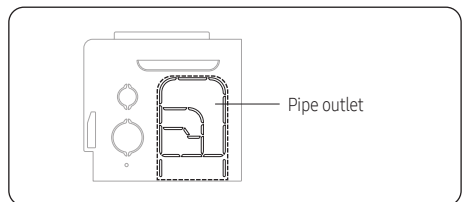

- Cut the pipe outlet to the exact pipe size. In addition, remove foreign substances and burrs around the outlet.
- Perform cutting with only a cutter (ex. nipper) and never tap with a hammer near the pipe outlet. Otherwise, it may cause product damage such as warping of the cabinet.
- After connecting the pipes with the Pipe outlet, plug the space around the pipes.
- Attach a full-thread bolt hanger every 3.28 to 4.92 ft (1 to 1.5 m) along the pipe to fix it in place.

- After connecting the pipes, proceed exactly as directed in the guide to prevent interference with the internal parts.
- Tighten the nuts to the specified torques. If overtightened, the nuts could be broken so refrigerant may leak.
- Protect or enclose refrigerant tubing to avoid mechanical damage.
- After installing pipes, block the unused knock-out holes to prevent small animals from entering. However, the radiant heat hole(A) should be able to intake air.

Step 6 Optional: Cutting and flaring the pipes

- 1 Make sure that you have the required tools available. (pipe cutter, reamer, flaring tool, and pipe holder)
- 2 If you wish to shorten the pipes, cut them with a pipe cutter, taking care to ensure that the cut edge remains at a 90° angle with the side of the pipe. Refer to the illustrations below for examples of edges cut correctly and incorrectly.

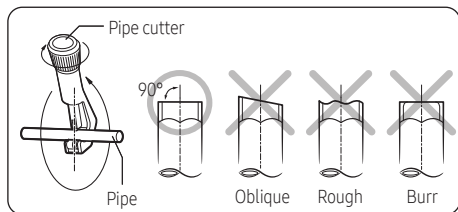

- 3 To prevent any gas from leaking out, remove all burrs at the cut edge of the pipe, using a reamer.

- 4 Slide a flare nut onto the pipe and create the flare.

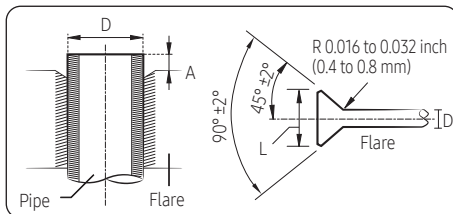

Outer Diameter (D)		Depth (A)		Flare dimension (L)	
mm	inch	mm	inch	mm	inch
Ø6.35	1/4	1.3	0.051	8.7 to 9.1	0.34 to 0.36
Ø9.52	3/8	1.8	0.071	12.8 to 13.2	0.50 to 0.52
Ø12.70	1/2	2.0	0.079	16.2 to 16.6	0.64 to 0.65
Ø15.88	5/8	2.2	0.087	19.3 to 19.7	0.76 to 0.78
Ø19.05	3/4	2.2	0.087	23.6 to 24.0	0.93 to 0.94

- 5 Check that the flaring is correct, refer to the illustrations below for examples of incorrect flaring.

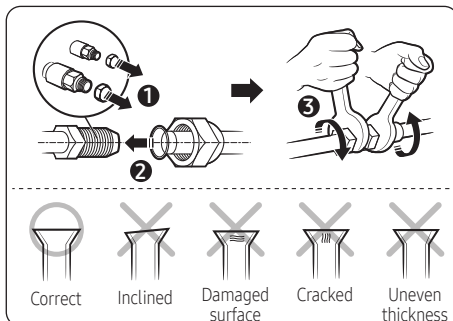

CAUTION

- Keep the piping length at a minimum to minimize the additional refrigerant charge due to piping extension.

Installation Procedure

- When connecting the pipes, make sure that surrounding objects do not interfere with or contact them to prevent refrigerant leakage due to physical damage.
- Make sure that the spaces where the refrigerant pipes are installed comply with all national, state, and local regulations.
- Be sure that the area where pipe brazing and adding additional refrigerant is well ventilated.
- Be sure that when performing brazing and mechanical connections the refrigerant does not circulate.
- When reconnecting the pipes, make sure to perform flared-jointing newly to prevent refrigerant leakage.
- When working on the refrigerant pipes and the flexible refrigerant connectors, be careful that they are not damaged physically by surrounding objects.
- For installation with handling the R-32 refrigerant, use the special tools for the R-32 refrigerant (manifold gauge, vacuum pump, charging hose, etc.).
- During tests never pressurize the appliances with a pressure higher than the maximum allowable pressure (as indicated on the nameplate of the unit).
- Never directly touch any accidental leaking refrigerant. This could result in severe wounds caused by frostbite.
- Never install a dryer on this unit to guarantee its lifetime.
- If the pipes require brazing, ensure that OFN (Oxygen Free Nitrogen) is flowing through the system.

- The nitrogen blowing pressure range is 2.9 to 7.3 psi(0.02 to 0.05 MPa).
- If the piping exceeds the standard pre-charged lengths, additional refrigerant must be added to the system. Otherwise, the indoor unit may freeze.
- While removing burrs, put the pipe face down to make sure that the burrs do not get into the pipe.

Step 7 Connecting up and removing air in the circuit

CAUTION

- When installing, make sure there is no leakage. When recovering the refrigerant, ground the compressor first before removing the connection pipe. If the refrigerant pipe is not properly connected and the compressor works with the service valve open, the pipe inhales the air and it makes the pressure inside of the refrigerant cycle abnormally high. It may cause an explosion and injury.

The outdoor unit is loaded with sufficient R-32 refrigerant. Do not vent R-32 into the atmosphere: it is a fluorinated greenhouse gas, covered by the Kyoto Protocol, with a Global Warming Potential (GWP) = 675.

You should purge the air in the indoor unit and the pipe. If air remains in the refrigerant pipes, it affects the compressor. It may cause a reduction of cooling/heating capacity and malfunction. Use a Vacuum Pump as seen in the picture.

- 1 Connect each assembly pipe to the appropriate valve on the outdoor unit and tighten the flare nut.

- 2 Referring to the illustration below, tighten the flare nut on section D first by hand and then with a torque wrench, applying the following torque.

Outer Diameter (D)	Torque [lbf•ft(N•m)]
ø1/4"(6.35mm)	10.3~13.3(14~18)
ø3/8"(9.52mm)	25.1~31.0(34~42)
ø1/2"(12.70mm)	36.1~45.0(49~61)
ø5/8"(15.88mm)	50.2~60.5(68~82)
ø3/4"(19.05mm)	73.8~88.5(100~120)

- 3 Connect the charging hose of the low pressure side of the manifold gauge to the packed valve having a service port as shown in the figure.

CAUTION

- The designs and shapes are subject to change according to the model.

- 4 Open the valve of the low pressure side(A) of the manifold gauge counterclockwise.

- AC018DXSCCG, AC024DXADCG, AC024DXSCCF

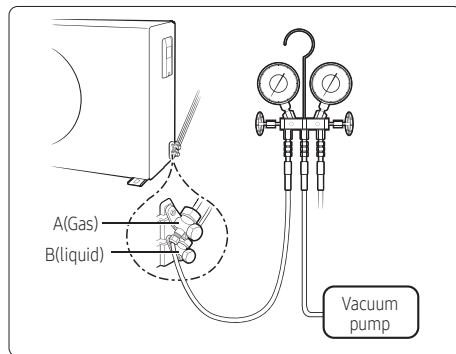

- AC024/030/036/048DXSCCG, AC030/036/048DXADCG, AC030/036DXSCCF

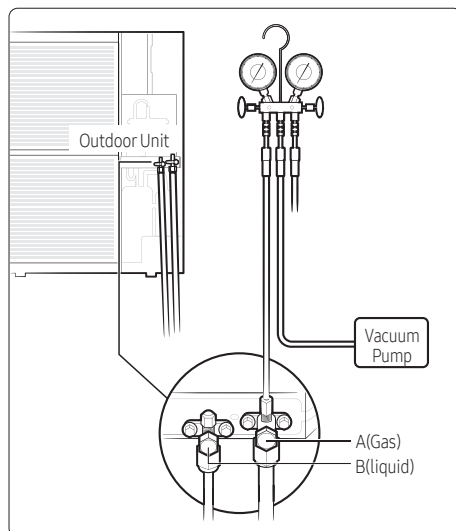

Installation Procedure

- 5 Purge the air from the system using a vacuum pump for about 10 minutes.
 - 1) Evacuate until 4000 microns is achieved, for at least 10 minutes.
 - 2) Close the gauge manifold valve, shut off the vacuum pump, and remove the common hose.
 - 3) Connect the hose to the nitrogen pressure regulator and bleed the hose by opening the end of the common hose closest to the manifold.
 - 4) Open the high-pressure manifold valve and slowly bring the system pressure to the atmosphere (101 kPa (14.64 psi)).
 - 5) Close the manifold and nitrogen cylinder and remove the common hose.
 - 6) Reconnect the common hose to the vacuum pump. Repeat steps 1) through 6), alternating between breaking the vacuum with dry nitrogen and evacuating, until system evacuation has occurred three times, to the following vacuum levels: Evacuation Microns

Evacuation	Microns
First	4000
Second	2000
Third	500

- 7) After evacuating to at least 500 microns for the third time, close the gauge manifold valve and wait 10 minutes, making sure that the vacuum level in the system does not decrease. If it does, a small leak is likely. Repair the leak and repeat the evacuation process.
- 6 Remove the hose of the low pressure side of the manifold gauge.
- 7 Open the stop valve of both liquid and gas sides.
- 8 Mount the valve stem nuts and the service port cap to the valve, and tighten them at the torque of 158.8 lbf•in (183 kgf•cm) with a torque wrench.
- 9 Check for gas leakage.
 - At this time, especially check for gas leakage from the 3-way valve's stem nuts(A port), and from the service port cap.

⚠ CAUTION

- Connect the indoor and outdoor units using pipes with flared connections (not supplied). For the lines, use insulated, unwelded, degreased and deoxidized copper pipe, (Cu DHP type to ISO 1337 or UNI EN 12735-1), suitable for operating pressures of at least 4.25 MPa (616.41 psi) and for a burst pressure of at least 17.0 MPa(2527.48 psi). Copper pipe for hydro sanitary applications is completely unsuitable.

- For sizing and limits (height difference, line length, max. bends, refrigerant charge, etc.) see "Connecting refrigerant pipe section".

Step 8 Performing the gas leak test

To detect basic refrigerant leaks, before creating the vacuum and circulating the R-32, it is the responsibility of the installer to pressurize the whole system with nitrogen (using a cylinder with a pressure reducer) at a pressure of 4.0 MPa(594.7 psi)

LEAK TEST WITH R-32 (after opening valves)

Before opening valves, discharge all the nitrogen into the system and create a vacuum. After opening valves check leaks using a leak detector for refrigerant R-32. Once you have completed all the connections, check for possible leaks using a leak detector specifically designed for HFC refrigerants.

- AC018DXSCCG, AC024DXADCG, AC024DXSCCF

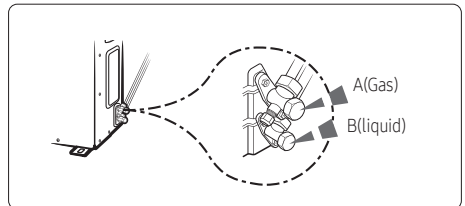

- AC024/030/036/048DXSCCG, AC030/036/048DXADCG, AC030/036DXSCCF

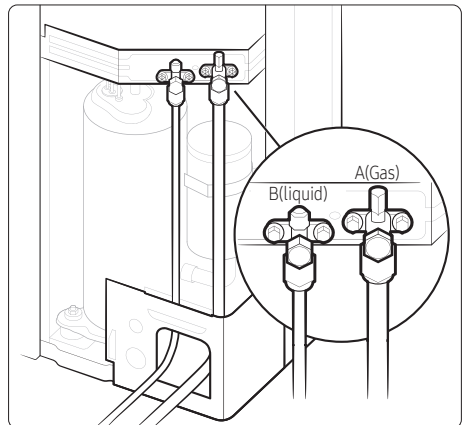

Step 9 Adding refrigerant (R-32)

Precautions on adding the R-32 refrigerant

In addition to the conventional charging procedure, the following requirements shall be kept.

- Make sure that contamination by other refrigerants does not occur for charging.
- To minimize the amount of refrigerant, keep the hoses and lines as short as possible.
- The cylinders shall be kept upright.
- Make sure that the refrigeration system is grounded before charging.
- Label the system after charging, if necessary.
- Extreme care is required not to overcharge the system.
- Before charging, the pressure shall be checked with nitrogen blowing.
- After charging, check for leakage before commissioning.
- Be sure to check for leakage before leaving the work area.

The outdoor unit is pre-charged with sufficient refrigerant for the standard piping. Thus, refrigerant must be added if the piping is longer than the standard length. This operation can only be performed by a qualified refrigeration specialist. To determine the quantity of refrigerant charge, see **Calculating the quantity of refrigerant to add** on page 37.

- AC018DXSCCG, AC024DXADCG, AC024DXSCCF
- 1 Open the liquid stop valve and gas stop valve.
 - 2 Operate the air conditioner by pressing the K2 button on the outdoor unit PCB.

- 3 After about 30 minutes, charge the refrigerant through the service port of the gas stop valve.

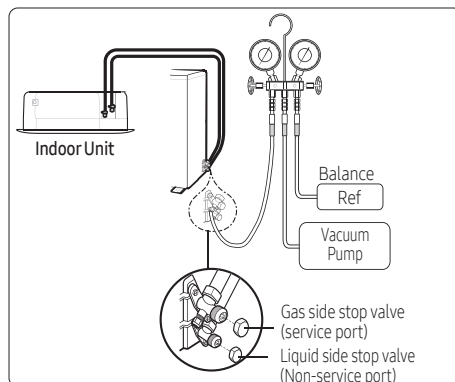

- AC024/030/036/048DXSCCG, AC030/036/048DXADCG, AC030/036DXSCCF

- 1 Check if the stop valve is closed completely.
- 2 Charge the refrigerant through the service port of the liquid stop valve.

NOTE

- Do not charge the refrigerant through the service port of the gas stop valve.
- 3 If you have any difficulty charging the refrigerant as described in the steps above, take the following steps:
 - a Open the liquid stop valve and gas stop valve.
 - b Operate the air conditioner by pressing the K2 button on the outdoor unit PCB.
 - c After about 30 minutes, charge the refrigerant through the service port of the gas stop valve.

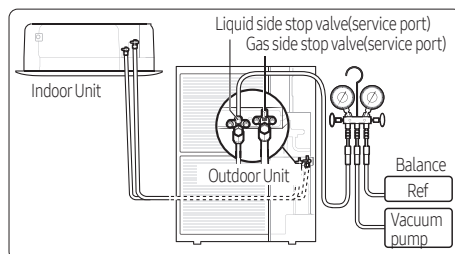

Installation Procedure

Precautions on adding R-32 refrigerant

In addition to the conventional charging procedure, the following requirements shall be kept.

⚠ CAUTION

- Make sure that contamination by other refrigerants does not occur for charging.
- To minimize the amount of refrigerant, keep the hoses and lines as short as possible.
- The cylinders shall be kept upright.
- Make sure that the refrigeration system is earthed before charging.
- Label the system with the final system charge with indelible ink.
- Extreme care is required not to overcharge the system.
- If the system must be evacuated for any reason, before recharging system tightness must be checked with nitrogen.
- After charging, check for leakage before commissioning.
- Be sure to check for leakage before leaving the work area.

⚠ CAUTION

Please fill in the following with indelible ink on the refrigerant charge label supplied with this product and on this manual.

- ① the factory refrigerant charge of the product,
- ② the additional refrigerant amount charged in the field and
- ① + ② the total refrigerant charge. on the refrigerant charge label supplied with the product.

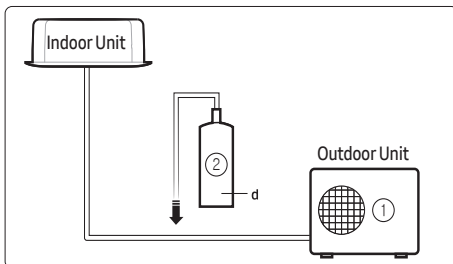

Unit	oz(g)
①, a	
②, b	
① + ②, c	

📄 NOTE

- Factory refrigerant charge of the product: see unit nameplate
- Additional refrigerant amount charged in the field (Refer to the above information for the quantity of refrigerant replenishment.)
- Total refrigerant charge
- Refrigerant cylinder and manifold for charging

⚠ CAUTION

- Make sure that the total refrigerant charge does not exceed (A), the maximum refrigerant charge, which is calculated in the following formula: Maximum refrigerant charge (A) = factory refrigerant charge (B) + maximum additional refrigerant charge due to piping extension (C)
- The table below shows the refrigerant charge limits for each product.

(Unit : oz(g))

Model	A	B	C
AC018DXSCCG	82.5(2337.5)	60.0(1700.0)	22.5(637.5)
AC024DXSCCG	103.6(2937.5)	81.1(2300.0)	22.5(637.5)
AC030DXSCCG	194.9(5525.0)	123.5(3500.0)	71.4(2025.0)
AC036DXSCCG	194.9(5525.0)	123.5(3500.0)	71.4(2025.0)
AC048DXSCCG	194.9(5525.0)	123.5(3500.0)	71.4(2025.0)
AC024DXADCG	82.5(2337.5)	60.0(1700.0)	22.5(637.5)
AC030DXADCG	140.2(3975.0)	95.2(2700.0)	45.0(1275.0)
AC036DXADCG	140.2(3975.0)	95.2(2700.0)	45.0(1275.0)
AC048DXADCG	173.7(4925.0)	102.3(2900.0)	71.4(2025.0)
AC024DXSCCF	82.5(2337.5)	60.0(1700.0)	22.5(637.5)
AC030DXSCCF	140.2(3975.0)	95.2(2700.0)	45.0(1275.0)
AC036DXSCCF	140.2(3975.0)	95.2(2700.0)	45.0(1275.0)

Charging the refrigerant under conditions of liquid by using a liquid pipe

It is necessary for recharging under conditions of liquid. When recharging refrigerant from the refrigerant cylinder to the equipment, follow the instructions below.

- Before recharging, check whether the cylinder has a siphon or not. There are two ways to recharge the refrigerant.

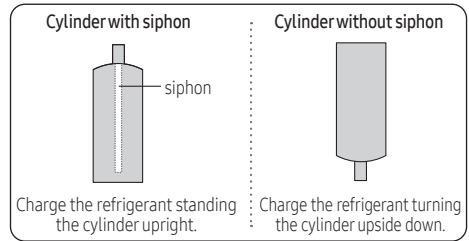

NOTE

- During the weigh-in operation of refrigerant quantity added use an electronic balance. If the cylinder doesn't have a siphon, invert it.

Calculating the quantity of refrigerant to add

The quantity of additional refrigerant is variable according to the installation situation. Thus, make sure the outdoor unit situation before adding refrigerant. This operation can only be performed by a qualified refrigeration specialist.

When installing the outdoor unit only

Model	Inter-connection pipe length [ft(m)]	
	0~24.6(0~7.5)	24.6~164.0(7.5~50)
AC018DXSCCG	0	+0.161 oz/ft over 24.6ft (+15g/m over 7.5 m)
AC024DXSCCG		
AC024DXADCG		
AC024DXSCCF		

Model	Inter-connection pipe length [ft(m)]	
	0~24.6(0~7.5)	24.6~164.0(7.5~50)
AC030DXADCG	0	0.323 oz/ft over 24.6ft (+30g/m over 7.5 m)
AC036DXADCG		
AC030DXSCCF		
AC036DXSCCF		

Model	Inter-connection pipe length [ft(m)]	
	0~24.6(0~7.5)	24.6~246.0(7.5~75)
AC030DXSCCG	0	0.323 oz/ft over 24.6ft (+30g/m over 7.5 m)
AC036DXSCCG		
AC048DXSCCG		
AC048DXADCG		

Installation Procedure

Step 10 Connecting the drain hose to the outdoor unit

- When using the air conditioner in the heating mode, ice may accumulate. During de-icing (defrost operation), the condensed water must be drained off safely. Consequently, you must install a drain hose on the outdoor unit, following the instructions below.
(For AC018/024/030/036/048DXSCCG, AC024/030/036DXSCCF model, do not install a drain hose and a drain plug.)

- 1 Make space more than 3.15 inches(80 mm) between the bottom of the outdoor unit and the ground for the installation of the drain hose, as shown in the figure.
- 2 Insert the drain plug into the hole on the underside of the outdoor unit.
- 3 Connect the drain hose to the drain plug.
- 4 Ensure that the drained water runs off correctly and safely. If needed apply a heating cable to prevent freezing of the drain hose/ pipe.

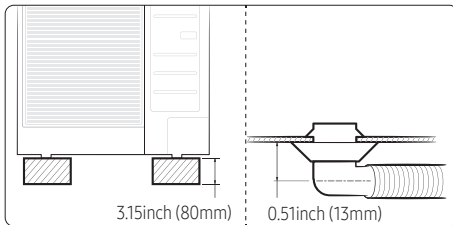

- 5 Be sure to plug the rest of the drain holes not connected with drain plugs using drain caps.
- AC024/030/036/048DXADCG

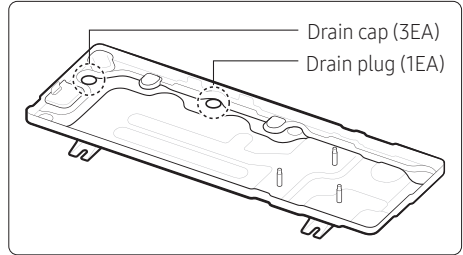

- When installing the product, make sure that the rack is not placed under the drain hole.
- If the product is installed in a region of heavy snow, allow enough separation distance between the product and the ground.

⚠ CAUTION

- For the AC018/024/030/036/048DXSCCG, AC024/030/036DXSCCF model, do not install a drain hose, a drain plug, or a drain cap. (Let the water drain naturally.)
- Ice may form on the ground. Take appropriate measures to prevent ice formation.

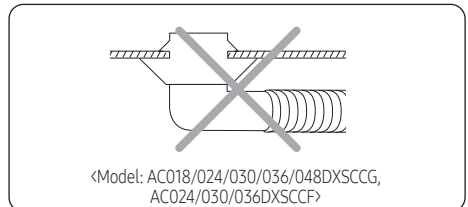

Step 11 Insulating the refrigerant pipes

- Once you have checked that there are no leaks in the system, you can insulate the piping and hose.

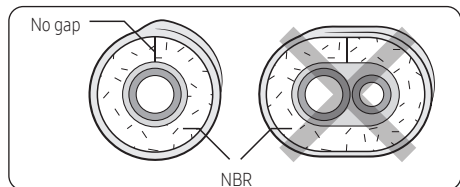

NOTE

- When insulating the pipe, be sure to overlap the insulation.
- Only use insulation that meets all applicable national, state, and local code requirements.

CAUTION

- When insulating the pipe, use a non-slit insulator.
- Select the insulation of the refrigerant pipe.
 - Insulate the gas side and liquid side pipe referring to the thickness according to the pipe size.
 - Less than Indoor temperature of 86°F(30°C) and humidity of 85% is the standard condition. If installing in a high humidity condition, use one grade thicker insulator by referring to the table below. If installed in unfavorable conditions, use a thicker one.
 - The insulator's heat-resistance temperature should be more than 248°F(120°C).

Pipe	Outer diameter		Insulation Type (Cooling, Heating)				Remarks		
			General [86°F(30°C), 85%]		High humidity [86°F(30°C), over 85%]				
			EPDM, NBR						
			mm	inch	mm	inch		mm	inch
Liquid pipe	6.35 ~ 9.52	1/4-3/8	9	3/8	9	3/8	Heating resisting temperature over 248°F(120°C)		
	12.7 ~ 50.80	1/2-2	13	1/2	13	1/2			
Gas pipe	6.35	1/4	13	1/2	19	3/4			
	9.52 ~ 25.4	3/8-1	19	3/4	25	1			
	28.58 ~ 44.45	11/8-1 3/4	19	3/4	32	11/4			
	50.8	2	25	1	38	11/2			

- When installing insulation in places and conditions below, use the same insulation that is used for high humidity conditions.
 - <Geological condition>
 - High humidity places such as shorelines, hot springs, near lakes or rivers, and ridges (when part of the building is covered by earth and sand.)
 - <Operation purpose condition>
 - Restaurant ceiling, sauna, swimming pool, etc.
 - <Building construction condition>
 - The ceiling is frequently exposed to moisture and cooling is not covered.
 - e.g. The pipe installed in a corridor of a dormitory and studio or near an exit that opens and closes frequently.
 - The place where the pipe is installed is highly humid due to the lack of a ventilation system.

Installation Procedure

Step 12 Checking the grounding

If the power distribution circuit does not have a ground or the grounding does not comply with specifications, a grounding electrode must be installed according to the applicable national, state, and local code requirements. The corresponding accessories are not supplied with the air conditioner.

Step 13 Performing final check and trial operation

- 1 Check the power supply between the outdoor unit and the auxiliary circuit breaker.
 - 1 phase power supply : L, N
- 2 Check the indoor unit.
 - a Check that you have connected the power and communication cables correctly. (If the power cable and communication cables are mixed up or connected incorrectly, the PCB will be damaged.)
 - b Check that the thermistor sensor, drain pump/hose, and display are connected correctly.

- 3 Press K1 or K2 on the outdoor unit PCB to run the test mode and stop.

(※AC***DXSCCF models are cooling-only models, in which running the test mode using K1 is not possible.)

Key	Push type	Mode	Display				
			SEG1	SEG2	SEG3	SEG4	
K1	Short	1st	Heating test mode	F	1	8	8
		2nd	Defrost test mode ¹⁾	F	3	8	8
		3rd	End Key operation	8	8	8	8
K2	Short	1st	Cooling test mode	F	2	8	8
		2nd	Inverter check ²⁾	F	4	8	8
		3rd	Pump down	F	6	8	8
		4th	Unusual	F	8	8	8
		5th	Inverter Fault Detection (Comp#1) ³⁾	F	A	8	8
		6th	Auto trial operation	F	E	8	8
		7th	Auto check (Install commissioning mode)	F	E	8	8
		8th	End Key operation	8	8	8	8
K3	Short	1st	Reset Release Eco mode	8	8	8	8

¹⁾ Defrost test mode

Condition 1: The outdoor temperature is below 50°F (10°C).

Condition 2: All the temperature conditions should meet the defrost conditions.

²⁾ To use the inverter check function, you must use the inverter checker.

³⁾ Indication on the display and action to take when an inverter fault is detected

	INV#1				Action to take
	SEG1	SEG2	SEG3	SEG4	
Fault detection is in progress	7	1	8	8	-
OK	7	1	0	F	-
NG	7	1	A	G	PBA defect: Replace the PBA
Check	7	1	E	H	Manual inspection is required
Going into fault detection mode failed	7	1	F	L	Try fault detection again

- AC018DXSCCG, AC024DXADCG, AC024DXSCCF

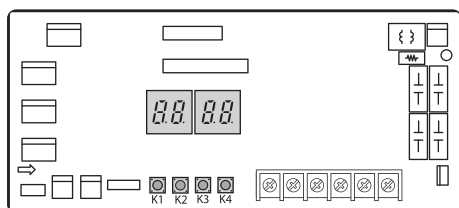

- AC024/030/036/048DXSCCG, AC030/036/048DXADCG, AC030/036DXSCCF

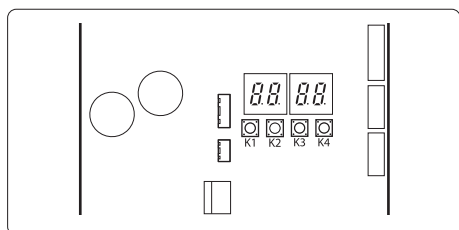

- After 12 minutes of operation check the discharged air temperature of the indoor unit
 - Cooling mode (indoor unit check) → Inlet air temp. - Outlet air temp.: From 18°F(10.0 °C) to 22°F(12.2 °C)
 - Heating mode (indoor unit check) → Outlet air temp. - Inlet air temp.: 20°F(11.1 °C) to 25°F(13.8 °C)
 - In heating mode, the indoor fan motor can remain off to avoid cold air blown into the air-conditioned space.
(※ AC***DXSCCF models are cooling-only models and do not support heating mode.)
 - How to reset the power supply of the outdoor unit and deactivate the eco mode (standby mode):
 - Press the K3 button for over 1 sec to reset the power supply of the outdoor unit and deactivate the eco mode (standby mode).
- ※ Eco mode : Standby for minimizing power consumption

Installation Procedure

- 6 View mode: When the K4 switch is pressed, you can see information about the system state as below.
- For a function that is not supported, "-" is shown for SEG2, SEG3 or SEG4.

K4 short push	Display contents	SEG1	SEG2	SEG3	SEG4	Unit
1	Target frequency	1	Hundreds digit	Tens digit	Units digit	Hz
2	Current frequency	2	Hundreds digit	Tens digit	Units digit	Hz
3	The number of preset indoor units	3	Hundreds digit	Tens digit	Units digit	EA
4	Ambient temperature sensor	4	Hundreds digit or "-" ¹⁾	Tens digit	Units digit	°C or °F ²⁾
5	Compressor discharge sensor	5	Hundreds digit	Tens digit	Units digit	°C or °F ²⁾
6	Eva-Mid sensor	6	Hundreds digit or "-" ¹⁾	Tens digit	Units digit	°C or °F ²⁾
7	Condenser sensor	7	Hundreds digit or "-" ¹⁾	Tens digit	Units digit	°C or °F ²⁾
8	Current	8	Tens digit	Units digit	The first place of decimals	A
9	Outdoor fan RPM	9	Thousands digit	Hundreds digit	Tens digit	rpm
10	Target discharge temperature	A	Hundreds digit or "-" ¹⁾	Tens digit	Units digit	°C or °F ²⁾
11	EEV	B	Hundreds digit	Tens digit	Units digit	step
12	The capacity sum of indoor units	C	Tens digit	Unit digit	The first place of decimals	kW or kBtu/h ³⁾
13	Protective control	D	0: Cooling 1: Heating	Protective control 0: No Protective control 1: Freezing 2: Non-stop defrosting 3: Over-load 4: Discharge 5: Total electric current	Frequency status 0: Normal 1: Hold 2: Down 3: Up_limit 4: Down_limit	-
14	IPM temperature	E	Hundreds digit or "-" ¹⁾	Tens digit	Units digit	°C or °F ²⁾
15	The number of connected indoor units	F	Hundreds digit	Tens digit	Units digit	EA
16	ESC EEV(CAM)	G	Hundreds digit	Tens digit	Units digit	step
17	ESC IN sensor	H	Hundreds digit or "-" ¹⁾	Tens digit	Units digit	°C or °F ²⁾
18	ESC OUT sensor	I	Hundreds digit or "-" ¹⁾	Tens digit	Units digit	°C or °F ²⁾
19	View mode end	BLANK	BLANK	BLANK	BLANK	

¹⁾ Sub-zero temperatures are expressed as a minus, instead of a hundred digit.

²⁾ The temperature unit can be switched between Celsius and Fahrenheit by Setting outdoor unit option switches. (Default value is Celsius.)

³⁾ If the temperature unit is set to Fahrenheit through the Setting outdoor unit option switches, the value is expressed in the unit of kBtu/h.

		Display contents	SEG1	SEG2	SEG3	SEG4
K4 long push	-	Main micom version	Year (Dec)	Month (Hex)	Date (Tens digit)	Date (Units digit)
	After short push 1	Inverter micom version	Year (Dec)	Month (Hex)	Date (Tens digit)	Date (Units digit)
	After short push 2	E2P version	Year (Dec)	Month (Hex)	Date (Tens digit)	Date (Units digit)
	After short push 3	Page 1 - AUTO Page 2 - (SEG1,2 - Indoor : "A","0") (SEG3,4 - Address : ex) 00)				
	After short push 4	Page 1 - MANU Page 2 - (SEG1,2 - Indoor : "A","0") (SEG3,4 - Address : ex) 00)				

Long push K4 (Main micom ver.) → short push 1 more (Inv. micom ver.) → short push 1 more (E2P. ver.) → short push 1 more (Automatic address) → short push 1 more (Manual address) → short push 1 more (Main micom ver.) → → Long push K4 (View mode end)

7 Setting outdoor unit option switch and address manually

- a Setting the option
 - Press and hold K2 to enter the option setting. (Only available when the operation is stopped)
 - If you enter the option setting, the display will show the following.

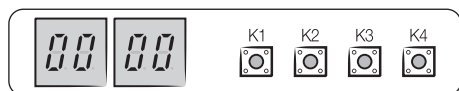

- Seg 1 and Seg 2 will display the number for the selected option.
- Seg 3 and Seg 4 will display the number for the set value of the selected option.
- If you have entered the option setting, you can shortly press the K1 switch to adjust the value of Seg 1, and Seg 2 and select the desired option.

Example)

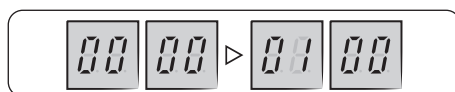

- If you have selected the desired option, you can shortly press the K2 switch to adjust the value of Seg 3, and Seg 4 and change the function for the selected option.

Example)

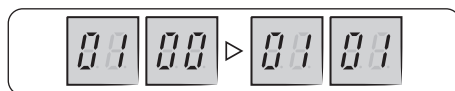

- After selecting the function for options, press and hold the K2 switch for 2 seconds. The edited value of the option will be saved when the entire segment blinks and tracking mode begins.

Option item	Input unit	SEG1	SEG2	SEG3	SEG4	Function
Channel address	Main	0	0	A	U	Automatic setting (Factory default)
				00~15		Manual setting

Installation Procedure

Option item	Input unit	SEG1	SEG2	SEG3	SEG4	Function
Snow accumulation prevention control	Main	0	1	0	0	Disabled (Factory default)
				0	1	Enabled
Step for Silence mode	Main	0	2	0	0	Disabled (Factory default)
				0	1	Step1
				0	2	Step2
				0	3	Step3
Type of Silence mode	Main	0	3	0	0	Automatic Silence mode (Factory default)
				0	1	Manual Silence mode
Temperature unit	Main	0	4	0	0	Celsius (default)
				0	1	Fahrenheit
Not applicable	Main	0	5	0	0	Not applicable
				0	1	Not applicable
Current restriction rate ¹⁾	Main	0	6	0	0	100% (Factory default)
				0	1	95%
				0	2	90%
				0	3	85%
				0	4	80%
				0	5	75%
				0	6	70%
				0	7	65%
				0	8	60%
				1	0	50%
1	1	100%				

Option item	Input unit	SEG1	SEG2	SEG3	SEG4	Function
Dedicated mode for cooling/heating ²⁾	Main	0	7	0	0	Cooling / Heating operation (default)
				0	1	Cooling operation only
				0	2	Heating operation only

- ¹⁾ Current restriction rate : When the restriction option is set, cooling and heating performance may decrease.
- ²⁾ AC***DXSCCF models are cooling-only and do not support heating mode. These models operate in cooling mode only, even if "heating operation only" mode is enabled.

CAUTION

- The edited option will not be saved if you do not end the option setting as explained in the above instruction.
- ※ While setting the option, you may press and hold the K1 button to reset the value to the previous setting.
- ※ If you want to restore the setting to factory default, press and hold the K4 button while in the option setting mode.
 - If you press and hold the K4 button, the setting will be restored to factory default, but it doesn't mean that the restored setting is saved. Press and hold the K2 button. When the segments show that tracking mode is in progress, the setting will be saved.

Extra Procedures

Pumping down refrigerant

⚠ WARNING

- After installing the product, perform a leak test on the piping connections. After pumping down refrigerant to inspect or relocate the outdoor unit, stop the compressor and remove the connected pipes.
 - Do not operate the compressor while a valve is open due to refrigerant leakage from a pipe or an unconnected or incorrectly connected pipe. Failure to do so may cause air to flow into the compressor and too high pressure to develop inside the refrigerant circuit, leading to an explosion or product malfunction.

Pump-down is an operation intended to collect all the system refrigerant in the outdoor unit. This operation must be carried out before disconnecting the refrigerant pipe to avoid refrigerant loss to the atmosphere.

- 1 Turn the system on in cooling with the fan operating at high velocity and then let the compressor run for more than 5 minutes. (Compressor will immediately start, provided 3 minutes have elapsed since the last stop.)
- 2 Release the valve caps on High and Low pressure sides.
- 3 Use an L-wrench to close the valve on the high pressure side.
- 4 After approximately 2 minutes, close the valve on the low pressure side.
- 5 Stop the air conditioner's operation by pressing the  (Power) button on the indoor unit or remote control.
- 6 Disconnect the pipes.
 - AC018DXSCCG, AC024DXADCG, AC024DXSCCF

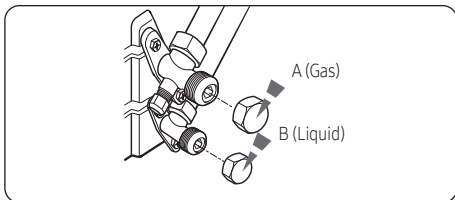

- AC024/030/036/048DXSCCG, AC030/036/048DXADCG, AC030/036DXSCCF

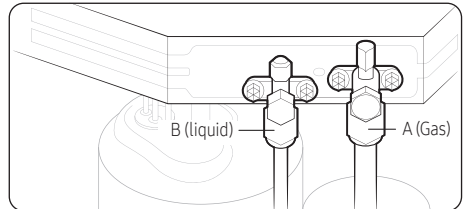

Relocating the indoor and outdoor units

- 1 Pump down refrigerant. See Pumping down refrigerant on page 45.
- 2 Disconnect the power supply only after rendering the system powerless from the main power.
- 3 Disconnect the assembly cable from the indoor and outdoor units.
- 4 Remove the flare nuts connecting the indoor units and the pipes. At this time, cover the pipes of the indoor unit and the other pipes using a cap or vinyl plug to avoid foreign material entering.
- 5 Disconnect the pipes connected to the outdoor units. At this time, cover the valve of the outdoor units and the other pipes using a cap or vinyl plug to avoid foreign material entering.

📖 NOTE

- Make sure you do not bend the connection pipes in the middle and store them with the cables.
- 6 Move the indoor and outdoor units to a new location.
- 7 Remove the mounting plate for the indoor unit and move it to a new location.

Extra Procedures

Using the stop valve

Opening the stop valve

- 1 Open the cap and turn the stop valve counterclockwise using a hexagonal wrench.
- 2 Turn it until the axis is stopped.

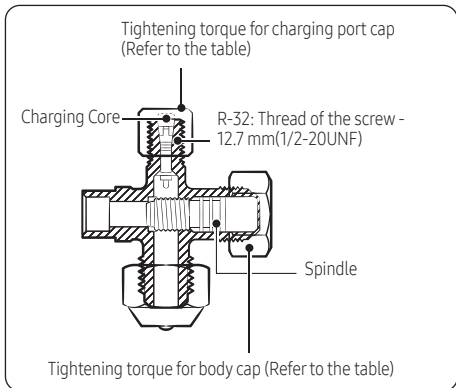

- 3 Tighten the cap securely.

Outer Diameter (mm)	Tightening torque	
	Body cap (N•m)	Charging port cap (N•m)
Ø 6.35	20 to 25	10 to 12
Ø 9.52	20 to 25	
Ø 12.70	25 to 30	
Ø 15.88	30 to 35	
Over Ø 19.05	35 to 40	

- (1 N•m=10 kgf•cm)

NOTE

- Do not apply excessive force to the stop valve always use special instruments. Otherwise, the stopping box can be damaged, and the back sheet can leak.
- If the watertight sheet leaks, turn the axis back by half, tighten the stopping box, and then check for leaks again. If there is no leakage, tighten the axis entirely.

Closing the stop valve

- 1 Remove the cap.
- 2 Turn the stop valve clockwise by using a hexagonal wrench.
- 3 Tighten the axis until the valve reaches the sealing point.
- 4 Tighten the cap securely.

CAUTION

- When you use the service port, always use a charging hose, too.
- Check the leakage of refrigerant gas after tightening the cap.
- Must use a spanner and wrench when you open/ tighten the stop valve.

Extra procedures

Maintenance Procedures

Performing the gas leak tests for repair

When repairing the refrigerant circuit, the following procedure must be followed to avoid flammability.

- 1 Remove the refrigerant.
- 2 Flush the system with nitrogen.
- 3 Repeat the previous step several times until no refrigerant is within the system.
- 4 Perform the repair work.
- 5 Conduct a pressure test.
- 6 Purge the refrigerant circuit with inert gas.
- 7 Perform vacuuming.
- 8 Charge with refrigerant.
- 9 Perform a leak test.
- 10 It is recommended to perform a second leak test within one month.

CAUTION

- Compressed air or oxygen shall not be used.
- Flush the system with nitrogen, pressurize the refrigerant circuit until the working pressure is reached, ventilate to the atmosphere, and then pull down to a vacuum state.
- For the final nitrogen blowing charge, the system shall be ventilated down to atmospheric pressure.
- The procedure is vital in case of brazing on the piping.
- Make sure that the outlet of the vacuum pump is not close to any ignition sources and there is ventilation available.
- Do not apply any permanent inductive or capacitance loads to the circuit without ensuring that this will not exceed the permissible voltage and current permitted for the air conditioner.

Decommissioning

The following requirements must be fulfilled before and while taking the decommissioning procedure:

- Only qualified, licensed professionals shall perform refrigerant recovery and decommissioning. Before decommissioning, the worker shall become familiar with the product.
- The entire refrigerant charge shall be recovered safely.
- Before starting the process, oil and refrigerant samples shall be taken just in case analysis is required for reuse.
- Before starting the process, a power supply must be available.

- 1 Be familiar with the equipment details.
- 2 Isolate the system electrically.
- 3 Before starting the process, make sure that:
 - Any mechanical equipment is available for handling refrigerant cylinders.
 - All PPE (personal protective equipment) is available for servicing.
 - The recovery process shall be supervised by a competent person.
 - The recovery equipment and cylinders comply with the standards. Only approved cylinders, with pressure relief valves, for the type of refrigerant shall be used.
- 4 Pump down the refrigeration system, if possible.
- 5 If vacuuming is not possible, make a manifold so that refrigerant can be easily removed from the parts of the system.
- 6 Make sure that the cylinders are placed on the scales before recovery.
- 7 Run the recovery system following the manufacturer's instructions.

Maintenance Procedures

- 8 Do not overcharge the cylinders. (No more than 80 %)
- 9 Keep the cylinder within the maximum working pressure, even temporarily.
- 10 After charging, make sure that the cylinders and the equipment are promptly removed from the site and all isolation valves are closed.
- 11 Recovered refrigerant shall not be mixed or reused. It shall be processed according to national, state, and local regulations.
- 12 After decommissioning, the system shall be labeled stating that it has been decommissioned. The label shall be dated and signed.
- 13 Ensure that there are labels on the equipment indicating the equipment contains flammable refrigerant.

Installing the wind baffle

If you operate the cooling operation of the air conditioner in conditions where the ambient temperature is lower than 23°F (-5 °C) DB(Dry bulb), or the outdoor unit might be faced with strong wind directly, the wind baffle should be installed to prevent the outdoor unit fan from operating in reverse way.

※ Wind baffle is not supplied with the product.

- AC018DXSCCG, AC024DXADCG, AC024DXSCCF

AC018DXSCCG, AC024DXADCG, AC024DXSCCF

<Front View>

Make holes on the front side and attach the wind baffle using screws.

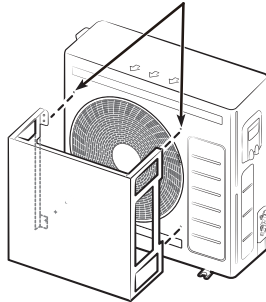

<Top Down View>

"A" – Should be 7 7/8" (200mm) or longer

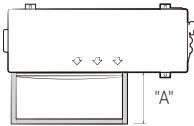

Partition

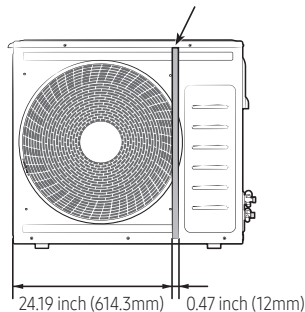

Installing the wind baffle

- AC024/030/036/048DXSCCG, AC030/036/048DXADCG, AC030/036DXSCCF

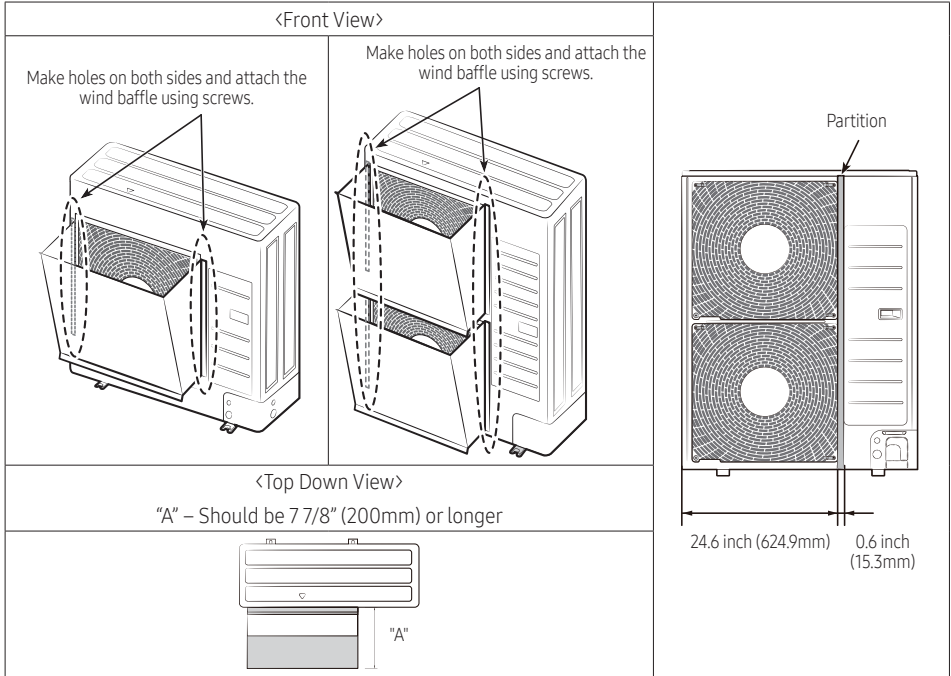

⚠ CAUTION

- When attaching the wind baffle using screws, be careful that the screws do not damage the partition and the heat exchanger.

📄 NOTE

- Install outdoor units with the back surface facing the wall side to eliminate the effects of external wind.

Installing the wind baffle

Appendix

Troubleshooting

The table below lists the self-diagnostic routines. For some of the error codes, you must contact an authorized service center.

If an error occurs during the operation, it is displayed on the outdoor unit PCB LED, both MAIN PCB and INVERTER PCB.

No.	Error Code	Meaning	Remarks
1	E108	Error due to duplicated communication address	Check on repeated indoor unit main address
2	E116	R-32 detection sensor 'Short' or 'Open' or 'Abnormal signal' error.	1. Check R-32 sensor connector. 2. Check R-32 sensor wire. 3. Check R-32 sensor. 4. Change R-32 sensor.
3	E118	Indoor fan controller PCB overheat error	Check Indoor fan controller PCB
4	E121	Error on room temperature sensor of indoor unit (Short or Open)	Indoor unit Room Thermistor Open/Short
5	E122	Error on EVA IN sensor of indoor unit (Short or Open)	Indoor unit EVA_IN Thermistor Open/Short
6	E123	Error on EVA OUT sensor of indoor unit (Short or Open)	Indoor unit EVA_OUT Thermistor Open/Short
7	E153	Error on float switch (2nd detection)	Indoor unit Float Switch Open/Short Drain Pump operation Check
8	E154	Indoor fan error	Check on indoor unit indoor Fan operation
9	E198	Error on thermal fuse of indoor unit (Open)	Thermal Fuse Open Check of indoor unit Terminal Block
10	E201	Communication error between the indoor unit and outdoor unit (Pre-tracking failure or when the actual number of indoor units are different from the indoor unit quantity setting on the outdoor unit) Error due to communication tracking failure after initial power is supplied (The error occurs regardless of the number of units.)	Check indoor quantity setting in outdoor
11	E202	Communication error between indoor unit and outdoor unit (When there is no response from indoor units after tracking is completed)	Check electrical connection and setting between indoor unit and outdoor unit
12	E203	Communication error between the outdoor unit and main micom (For PF #4 to #6 controllers, error will be determined from the time when the compressor is turned on.)	Check electrical connection and setting between outdoor unit MAIN PBA - INVERTER PBA

Appendix

No.	Error Code	Meaning	Remarks
13	E205	Main PBA - other PBA Communication error (All other PBA communication error)	1. Check Main PBA connectors 2. Check other PBA connectors 3. Change Mian PBA
14	E206	Main PBA - other PBA communication error (Some of PBA communication) C002 : Fan PCB communication error C003 : INV1 communication error	1. Check Main PBA connectors 2. Check other PBA connectors 3. Change other PBA
15	E221	Error on outdoor temperature sensor (Short or Open)	Check Outdoor sensor Open / Short
16	E231	Error on outdoor COND OUT sensor (Short or Open)	Check Cond-Out sensor Open / Short
17	E251	Error on discharge temperature sensor of compressor 1 (Short or Open)	Check Discharge sensor Open / Short
18	E320	Error on OLP sensor (Short or Open)	Check OLP sensor Open / Short
19	E321	Error on ESC IN temperature sensor (Short or Open)	Check ESC IN sensor Open / Short
20	E322	Error on ESC OUT temperature sensor (Short or Open)	Check ESC OUT sensor Open / Short
21	E381	INVERTER PCB overheat error	Check Outdoor Inverter PBA
22	E383	Outdoor Fan#1 PCB overheat error	1. Change motor 2. Change INV PCB
23	E403	Compressor down due to freeze protection control	Check Outdoor Cond.
24	E404	System stops due to overload protection control	Check Comp. when it starts
25	E416	System stops due to discharge temperature	-
26	E422	Blockage detected on high pressure pipe during cooling operation	1. Check if the service valve is open 2. Check for refrigerant leakage (pipe connections, heat exchanger) and charge refrigerant if necessary 3. Check if there's any blockage on the refrigerant cycle (indoor unit/ outdoor unit) 4. Check if additional refrigerant has been added after pipe extension
27	E425	Reverse phase or open phase	Check whether 3 phase is reversed or opened.
28	E440	Heating operation restricted at outdoor temperature over Theat_high value (default:30°C)	1. Check the range of temperature limited for heating operation 2. Check the outdoor temperature sensor

No.	Error Code	Meaning	Remarks
29	E441	Cooling operation restricted at outdoor temperature below Tcool_low value (default:0°C)	1. Check the range of temperature limited for cooling operation 2. Check the outdoor temperature sensor
30	E446	Outdoor Fan#1 motor Operation error	1. Change motor 2. Change INV PCB
31	E447	Outdoor Fan#1 motor wire disconnection error	1. Check motor connector 2. Change motor 3. Change INV PCB
32	E455	Outdoor Fan#1 IPM overheat error	1. Change motor 2. Change INV PCB
33	E458	Fan speed error	FAN1 ERROR
34	E461	Error due to operation failure of inverter compressor	-
35	E462	System stops due to full current control	-
36	E463	Over current trip / PFC over current error	Check OLP sensor
37	E464	IPM Over Current(O.C)	1. Check if the service valve is open 2. Check the state of refrigerant 3. Check if connecting wire and the pipe are OK 4. Check the compressor
38	E465	Comp. Overload error	-
39	E466	DC-Link voltage under/over error	Check AC Power and DC Link Voltage
40	E467	Error due to abnormal rotation of the compressor or unconnected wire of compressor	Check Comp wire
41	E468	Error on current sensor (Short or Open)	Check Outdoor Inverter PBA.
42	E469	Error on DC-Link voltage sensor (Short or Open)	-
43	E470	Outdoor unit EEPROM Read/Write error (Option)	Check Outdoor EEPROM Data
44	E471	Outdoor unit EEPROM Read/Write error (H/W)	Check Outdoor EEPROM PBA
45	E474	Error on IPM Heat Sink sensor of inverter 1 (Short or Open)	Check Outdoor Inverter PBA.
46	E475	Error on inverter fan 2	FAN2 ERROR
47	E478	Outdoor Fan#1 motor overcurrent error	1. Change motor 2. Change INV PCB
48	E483	Overvoltage of H/W detect DC link	Check AC Power
49	E484	PFC Overload (Over current) Error	Check Outdoor Inverter PBA.
50	E485	Error on input current sensor of inverter 1 (Short or Open)	Check Outdoor EEPROM PBA

Appendix

No.	Error Code	Meaning	Remarks
51	E486	Outdoor Fan#1 high voltage or low voltage error	1. Change motor 2. Change INV PCB
52	E488	Inverter input voltage sensor error	Check Outdoor Inverter PBA
53	E489	FAN #1 motor current limiting error	1. Change motor 2. Change INV PCB
54	E493	FAN #1 motor output current error	1. Change motor 2. Change INV PCB
55	E496	FAN #1 motor voltage sensor error	1. Change motor 2. Change INV PCB
56	E499	FAN #1 IPM temperature sensor error	1. Change motor 2. Change INV PCB
57	E500	IPM overheat error on inverter1	Check Outdoor Inverter PBA.
58	E507	Error due to high pressure switch open or compressor down by high pressure	-
59	E508	Smart install is not installed	-
60	E534	Blockage detected on high pressure pipe during heating operation.	1. Check if the service valve is open 2. Check if there's any blockage on the refrigerant cycle (indoor unit/outdoor unit) 3. Check the EEV connection and operation 4. Check if the connecting wire and the pipe are OK 5. Check the compressor
61	E554	Gas leak detected	Check the refrigerant
62	E556	Error due to mismatching capacity of indoor and outdoor unit	Check the indoor and outdoor unit capacity
63	E557	DPM remote controller option error	Check the indoor option code
64	E563	Error due to mismatching indoor and outdoor unit	Check the outdoor EEPROM data and indoor option code
65	E590	Inverter EEPROM Checksum error	-
66	E594	Fan EEPROM CheckSum error	1. Check Fan EEPROM
67	E601	Communication error between wired remote control and indoor unit	1. Check remote control wire connectors. 2. Change wired remote control.

No.	Error Code	Meaning	Remarks
68	E665	External Contact Input ERROR	<ol style="list-style-type: none"> 1. Check the External float switch connection. 2. Check whether the drain has been filled with water. 3. Check the emergency alarm system (Emergency Stop)
69	E695	R-32 detection sensor life unpredictable error	<ol style="list-style-type: none"> 1. Check R-32 sensor. 2. Change R-32 sensor.
70	E697	R-32 detection sensor 2nd detecting error	<ol style="list-style-type: none"> 1. Open the window to ventilate. 2. Contact service center.
71	E698	R-32 detection sensor failure error	<ol style="list-style-type: none"> 1. Check R-32 sensor connector. 2. Check R-32 sensor. 3. Change R-32 sensor.
72	E699	R-32 detection sensor replacement notification error	Change R-32 sensor.
73	E700	R-32 detection sensor Life-expiration error	Change R-32 sensor.

SAMSUNG