

Air conditioner

Installation manual

AC***DNLDCG, AC***DNHDCG

- Thank you for purchasing this Samsung air conditioner.
- Before operating this unit, please read this manual carefully and retain it for future reference.

Contents

Safety Information	3
Safety Information	3
Installation Procedure	8
Installation Procedure	8
Step 1 Checking and preparing accessories	8
Step 2 Choosing the installation location	8
Step 3 Optional: Insulating the body of the indoor unit	15
Step 4 Installing the indoor unit	15
Step 5 Purging inert gas from the indoor unit	17
Step 6 Cutting and flaring the pipes	17
Step 7 Connecting the assembly pipes to the refrigerant pipes	18
Step 8 Performing the gas leak test	19
Step 9 Insulating the refrigerant pipes	20
Step 10 Installing the drain hose and drain pipe	22
Step 11 Performing the drainage test	23
Step 12 Optional: Installing the external controller	24
Step 13 Connecting the power and communication cables	25
Step 14 Setting additional functions of wired remote control	27
Step 15 Optional : Setting the Emergency Temperature Output (ETO) function	30
Step 16 Setting the indoor unit option code with the wired remote control	32
Step 17 Setting indoor unit addresses and installation options with wired remote control	36
Step 18 Optional : Setting the indoor unit addresses and the installation options with the wireless remote control	40
Step 19 Optional : LED Display indicator specifications when checking Wi-Fi Easy Setup and Wi-Fi status	52
Step 20 Wi-Fi module Reinstallation guide	54
Appendix	58
Troubleshooting	58

Safety Information

California Proposition 65 Warning (US)

⚠ WARNING: Cancer and Reproductive Harm - www.P65Warnings.ca.gov.

IMPORTANT – This product has been designed and manufactured to meet ENERGY STAR criteria for energy efficiency when matched with appropriate coil components. However, proper refrigerant charge and proper air flow are critical to achieve rated capacity and efficiency. Installation of this product should follow the manufacturer's refrigerant charging and air flow instructions. Failure to confirm proper charge and airflow may reduce energy efficiency and shorten equipment life.

⚠ WARNING







- Hazards or unsafe practices that may result in severe personal injury or death.

⚠ CAUTION

- Hazards or unsafe practices that may result in minor personal injury or property damage.
- Carefully follow the precautions listed below because they are essential to guarantee the safety of the equipment.

⚠ WARNING

- Always disconnect the air conditioner from the power supply before servicing it or accessing its internal components.
- Verify that installation and testing operations are performed by qualified personnel.
- Verify that the air conditioner is not installed in an easily accessible area.

Symbol	Meaning
	Flammable gas
	Flammable materials
	Refrigerant safety group
	Read operating manual
	Refer to operating manual
	Read service manual

⚠ WARNING

The installation and testing of this appliance must be performed by a qualified technician.

- The instructions in this manual are not intended as a substitute for proper training or adequate experience in the safe installation of the appliance.

Always install the air conditioner in compliance with current local, state, and federal safety standards.

- Do not use means to accelerate the defrost operation or to clean, other than those recommended by Samsung.
- Do not pierce or burn.
- Be aware that refrigerants may not contain an odor.

Safety Information

General information

WARNING

- Carefully read the content of this manual before installing the air conditioner and store the manual in a safe place to be able to use it as a reference after installation.
- For maximum safety, installers should always carefully read the following warnings.
- Store the operation and installation manual in a safe location and remember to hand it over to the new owner if the air conditioner is sold or transferred.
- This manual explains how to install an indoor unit with a split system with two SAMSUNG units. The use of other types of units with different control systems may damage the units and invalidate the warranty. The manufacturer shall not be responsible for damages arising from the use of non-compliant units.
- The manufacturer shall not be responsible for damage originating from unauthorized changes or the improper connection of electricity and requirements outlined in the "Operating limits" table, included in the manual, shall immediately invalidate the warranty.
- All pipe work including piping material, pipe routing, and installation shall include protection from physical damage in operation and service and comply with national and local codes and standards, such as ASHRAE 15, ASHRAE 15.2, IAPMO Uniform Mechanical Code, ICC International Mechanical Code, or CSA B52. Any field joints shall be accessible for inspection before being covered or enclosed.
- The air conditioner should be used only for the applications for which it has been designed: the indoor unit is not suitable to be installed in areas used for laundry.
- Do not use the units if damaged. If problems occur, switch the unit off and disconnect it from the power supply.
- To prevent electric shocks, fires or injuries, always stop the unit, disable the protection switch and contact SAMSUNG's technical support if the unit produces smoke, if the power cable is hot or damaged or if the unit is very noisy.
- Always remember to inspect the unit, electric connections, refrigerant tubes and protections regularly. These operations should be performed by qualified personnel only.
- The unit contains moving parts, which should always be kept out of the reach of children.
- Do not attempt to repair, move, alter or reinstall the unit. If performed by unauthorized personnel, these operations may cause electric shocks or fires.
- Do not place containers with liquids or other objects on the unit.
- The air conditioner contains a refrigerant that has to be disposed of as special waste. At the end of its life cycle, the air conditioner must be disposed of in authorized centers or returned to the retailer so that it can be disposed of correctly and safely.

- Wear protective equipment (such as safety gloves, goggles, and headgear) during installation and maintenance work. Installation/repair technicians may be injured if improper protective equipment is worn.
- This unit is a partial unit air conditioner, complying with partial unit requirements of this International Standard, and must only be connected to other units that have been confirmed as complying with corresponding partial unit requirements of this International Standard.
- This appliance is not intended for use by persons (including children) with reduced physical, sensory, or mental capabilities, or lack of experience and knowledge unless they have been given supervision or instruction concerning the use of the appliance by a person responsible for their safety. Children should be supervised to ensure that they do not play with the appliance.

Installing the unit

WARNING

IMPORTANT: When installing the unit, always remember to connect first the refrigerant tubes, and then the electrical lines.

- Always disassemble the electric lines before the refrigerant tubes.
- Upon receipt, inspect the product to verify that it has not been damaged during transport. If the product appears damaged, DO NOT INSTALL it, and immediately report the damage to the carrier or retailer (if the installer or the authorized technician has collected the material from the retailer.)
- After completing the installation, always carry out a functional test and provide instructions on how to operate the air conditioner to the user.
- Do not use the air conditioner in environments with hazardous substances or close to equipment that releases free flames to avoid the occurrence of fires, explosions or injuries.
- Do not install the product on a ship or a vehicle (such as a campervan). Salt, vibration or other environmental factors may cause the product to malfunction, electric shock or fire.
- Excessive indoor humidity or clogged condensate drain lines may cause water to drip from indoor units. Do not install the indoor unit where dripping could result in damage to property, such as over electronic equipment or other sensitive instruments.
- Our units must be installed in compliance with the space specifications presented in the installation manual to ensure accessibility from both sides and allow repairs or maintenance operations to be carried out. The unit's components must be accessible and easy to disassemble without endangering people and objects.

- For this reason, where it is not observed as indicated in the Installation Manual, the cost necessary to reach and repair the unit (safely as required by local regulations) with slings, trucks, scaffolding or any other means of elevation won't be considered in warranty and charged to end user.
- If any gas or impurities, except R-32 refrigerant, come into the refrigerant pipe, a serious problem may occur and it may cause injury.
Use the supplied accessories, specified components and tools for the installation.
 - Do not use the pipe and the installation product used for the R-22, R-410A refrigerant.
 - Failure to use the specified components can cause the product to fall, water leakage, electrical shock, and fire. (The pipe and flare components used for R-22, R-410A refrigerant must not be used)
 - Excessive indoor humidity or clogged condensate drain lines may cause water to drip from indoor units. Do not install the indoor unit where dripping could result in property damage, such as over electronic equipment or other sensitive instruments.
- Auxiliary systems which may be a potential ignition source shall not be installed in the ductwork.
- The air conditioner contains a refrigerant that must be disposed of as special waste. At the end of its life cycle, the air conditioner must be disposed of in authorized centers or returned to the retailer so that it can be disposed of correctly and safely.
- AC***DNLDGC indoor unit is intended for free-air discharge or connection to a duct supplying only one room. Improper installation could contribute to the spread of smoke or flames in the event of a fire.
- Always verify that electric connections (cable entry, section of leads, protections...) are compliant with the electric specifications and with the instructions provided in the wiring scheme. Always verify that all connections comply with the standards applicable to the installation of air conditioners.
- Devices disconnected from the power supply should be completely disconnected in the condition of overvoltage category.

CAUTION

Make sure that you ground the cables.

- Do not connect the ground wire to the gas pipe, water pipe, lightning rod, or telephone wire. If the grounding is not complete, electric shock or fire may occur.

Install the circuit breaker.

- If the circuit breaker is not installed, electric shock or fire may occur.

Make sure that the condensed water dripping from the drain hose runs out properly and safely.

Install the power cable and communication cable of the indoor and outdoor unit at least 3.3ft (1m) away from the electric appliance.

Install the indoor unit away from a lighting apparatus using the ballast.

- If you use the wireless remote control, reception error may occur due to the ballast of the lighting apparatus.
- If the supply cord is damaged, it must be replaced by the manufacturer, its service agent or similarly qualified persons to avoid a hazard.

**Do not use the indoor unit for the preservation of food items, plants, equipment, and artwork.
This may cause deterioration of their quality.**

Do not install the indoor unit if it has any drainage problems.

Precautions for using R-32 refrigerant

General

- This product is pre-charged with mildly flammable gas classified as A2L by ASHRAE. The following precautions and instruction manuals must be followed during installation, operation, servicing and decommissioning of the product.
- The appliance shall be stored in a room without continuously operating ignition sources, like open flames, a gas appliance, or an electric heater.
- All national and local regulations shall be observed at all times.

Power supply line, fuse or circuit breaker

WARNING

- Always make sure that the power supply is compliant with current safety standards. Always install the air conditioner in compliance with current local safety standards.
- Always verify that a suitable grounding connection is available.
- Verify that the voltage and frequency of the power supply comply with the specifications and that the installed power is sufficient to ensure the operation of any other domestic appliance connected to the same electric lines.
- Always verify that the cut-off and protection switches are suitably dimensioned.
- Verify that the air conditioner is connected to the power supply following the instructions provided in the wiring diagram included in the manual.

Safety Information

- All pipe work including piping material, pipe routing and installation shall include protection from physical damage in operation and service, and comply national and local codes and standards, such as ASHRAE 15, ASHRAE 15.2, IAPMO Uniform Mechanical Code, ICC International Mechanical Code, or CSA B52. All filed joints shall be accessible for inspection before being covered or enclosed.
- All field piping and joints shall be pressure tested with an inert gas according to prevalent industry standards prior to refrigerant charging and system commissioning.
- Where additional field charging is required. The installer shall write with a permanent marker the field charge added on the ODU label provided, such that the Total Charge = Factory 'Pre-charge' + field charge.
- Minimum floor area of the room shall be in compliance with the min. room area according to the total charge of the installation according to Table 1.
- For ducted systems, any auxiliary systems that are potential ignition sources shall not be installed in the duct work. Examples of ignition sources are hot surfaces with temperatures exceeding 700°C and electric switching devices.
- Any auxiliary device installed must be approved by Samsung and must be suitable for operating with the refrigerant marked on the label.
- For mechanical ventilation the lower edge of the air extraction opening shall not be more than 3.9 inch (100mm) above the floor. The exhaust location outside the building must be at least 9.8ft (3m) away from the building opening and mechanical air intake openings.
- To handle, purge, and dispose of the refrigerant, or break into the refrigerant circuit, the worker should have a certificate from an industry-accredited authority.
- Non-ducted systems may be installed in the areas such as false ceilings not being used as return air plenum as long as the conditioned air does not mix with the air in the false ceilings.
- For ducted appliances false ceilings or drop ceilings may be used as return air plenum if a refrigerant leak detection system is provided in the system and any external connections are also provided with a sensor immediately below the return air plenum duct joint.
- Installation, servicing and any type of maintenance or repair must be performed by certified personnel that is competent to carry such activity in accordance with national and local regulations.

General Information on Servicing

- Do not work in a confined space. Ensure adequate ventilation is provided at the workspace during the entirety of the duration of the work to safely disperse any released refrigerant.
- All maintenance staff and others working in the local area shall be instructed on the nature of the work being performed and instructed to follow all instructions provided by Samsung, national and local authorities.
- The area shall be checked with an approved refrigerant detector before and during any work on the system.
- Have a dry CO₂ fire extinguisher adjacent to the charging area and workspace.
- The service personnel shall not use any ignition sources in a manner that it may lead to the risk of fire or explosion.
- Potential ignition sources shall be kept away from the work area where the flammable refrigerant can be released into the surrounding area.
- The work area should be checked to ensure that there are no flammable hazards or ignition risks. The "No Smoking" sign shall be attached.
- Under no circumstances shall potential sources of ignition be used upon detection of leakage.

The following checks shall be applied to installations and maintenance operations.

- The actual total refrigerant charge is in accordance with the room size in accordance with Table 1.
- The ventilation machinery and outlets are operating adequately and are not obstructed.
- Markings on the equipment are visible and legible.
- Refrigerant pipes or components are installed in a position where they are unlikely to be exposed to any substance which may corrode refrigerant containing components.

Initial checks of electrical devices shall include the following.

- That capacitors are discharged in a safe manner to avoid sparking.
- That no live electrical components and wiring are exposed while charging, recovering or purging the system.
- That there is continuity to earth bonding.
- Check that cabling is not worn, corroded or damaged in any manner.

Electrical repair safety measures

- All electrical components used or replaced must be to Samsung's specifications.
- If a fault exists that could compromise safety, then no electrical supply shall be connected to the circuit until it is satisfactorily dealt with.
- Sealed electrical components and intrinsically safe components shall be replaced and not repaired.
- Cabling should be protected from excessive vibration, pressure, sharp edges, and other adverse environmental factors.

Detection of flammable refrigerants

- Electronic leak detectors shall be used to detect flammable refrigerants, but the sensitivity may not be adequate or may need re-calibration. (Detection equipment shall be calibrated in a refrigerant-free area.)
- Make sure that the detector is not a potential source of ignition.
- Leak detection equipment shall be set at a percentage of the LFL (Lower flammable limit) of the refrigerant and shall be calibrated to the refrigerant employed and the appropriate percentage of gas (25% maximum) is confirmed.
- The use of detergents containing chlorine shall be avoided for cleaning because the chlorine may react with the refrigerant and corrode the piping.
- If leakage is suspected, naked flames shall be removed.
- If a leakage is found while brazing, the entire refrigerant shall be recovered from the product or isolated (e.g. using shut-off valves). It shall not be directly released into the environment. Oxygen-free nitrogen (OFN) shall be used for purging the system before and during the brazing process.
- The work area shall be checked with an appropriate refrigerant detector before and during work.
- Ensure that the leakage detector is appropriate for use with flammable refrigerants.

Removal and Evacuation

- When removing refrigerant for servicing it is recommended to remove the entire quantity.
- When removing refrigerant follow local and national regulations and follow best practices including;
 - evacuate;
 - purge the circuit with inert gas (optional for A2L);
 - evacuate (optional for A2L);
 - continuously flush or purge with inert gas when using flame to open circuit; and
 - open the circuit.

- Use proper recovery cylinders appropriate for the type of refrigerant.
- Follow prescribed industry best practices for purging and evacuation.
- Oxygen free nitrogen shall be used for purging the system.

Charging procedure

- Follow industry standard refrigerant charging best practices.
- Prior to recharging the system shall be pressure tested with oxygen free nitrogen gas.
- Ensure that contamination of different refrigerants does not occur when charging.
- Cylinders shall be kept in appropriate position as per instructions.
- The refrigerant system should be earthed prior to charging the system.
- Label the system when charging is completed.
- Take extreme care not to overfill the refrigeration system.
- The system shall be leak tested on completion of charging prior to commissioning.









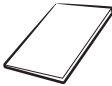

Decommissioning

- Only qualified licensed professionals shall perform refrigerant recovery and decommissioning.
- Isolate the system electrically.
- All recovery equipment and cylinders shall conform to appropriate standards. Only approved cylinders, with pressure relief valves, for the type of refrigerant shall be used.
- Recover refrigerant following industry standard procedure for flammable refrigerants.
- When draining compressors oil care must be taken that there is no flammable refrigerant in the compressor and that the compressor is not hot. Oil should be handled according to local and federal regulations.
- After decommissioning, the system shall be labeled stating that it has been decommissioned. The label shall be dated and signed. The label should state that it "contains flammable refrigerant".
- Ensure that there are labels on the equipment indicating the equipment contains flammable refrigerant.
- Recovered refrigerant shall not be mixed or reused. It shall be processed according to national, state and local regulations.

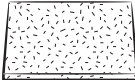
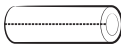
Installation Procedure

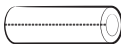
Step 1 Checking and preparing accessories

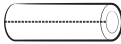
The following accessories are supplied with the indoor unit. The type and quantity may differ, depending on the specifications.

User manual (1)	Installation manual (1)
	
Clamp hose (1)	Flexible hose (1)
	
Insulation drain (1)	Thermal insulation sponge A (1)
	
Cable-tie (AC***DNLDGC : 4EA, AC***DNHDCG : 8EA)	Thermal insulation sponge B (1)
	
Rubber (4)	Thermal insulation sponge C (1)
	
Reducer (1)	Wi-Fi connecting Wire 55.12 inch (1400 mm) (1)
	

Step 2 Choosing the installation location

Installation location requirements

- There must be no obstacles near the air inlet and outlet.
- Install the indoor unit with a ceiling that can support its weight.
- Maintain sufficient clearance around the indoor unit.
- Before installing the indoor unit, check whether the chosen location has proper drainage possibilities.
- The indoor unit must be installed such that it is beyond public access and is not touchable by users.
- A vibration-resistant location that is not inclined (If the indoor unit is installed on a structure that is not sturdy, it may fall and get damaged or cause injury.)
- Where it is not exposed to direct sunshine.
- Where the air filter can be removed and cleaned easily.
- A location where animals cannot access and urinate on the product. Ammonia may be generated.

WARNING

- If appliances contain R-32 refrigerant, then the floor area of the room where the appliances are installed, operated and stored must be larger than the minimum floor area defined in the table below A [ft²(m²)].

<Table 1>

m [lb(kg)]	Minimum required room area A [ft ² (m ²)]			
	Reference Height [h _r , ft(m)]			
	7.2(2.2)	8.2(2.5)	8.9(2.7)	10.5(3.2)
≤ 4.047(1.836)	no room area restrictions			
4.049(1.837)	58.7(5.46)	51.7(4.80)	47.9(4.45)	40.4(3.75)
4.18(1.9)	60.8(5.64)	53.5(4.97)	49.5(4.60)	41.8(3.88)
4.40(2.0)	64.0(5.94)	56.3(5.23)	52.1(4.84)	44.0(4.08)
4.85(2.2)	70.4(6.54)	61.9(5.75)	57.3(5.33)	48.4(4.49)
5.29(2.4)	76.7(7.13)	67.5(6.27)	62.5(5.81)	52.8(4.90)
5.73(2.6)	83.1(7.72)	73.2(6.80)	67.7(6.29)	57.2(5.31)
6.17(2.8)	89.5(8.32)	78.8(7.32)	73.0(6.78)	61.6(5.72)
6.61(3.0)	95.9(8.91)	84.4(7.84)	78.2(7.26)	66.0(6.13)
7.05(3.2)	102(9.51)	90.1(8.37)	83.4(7.75)	70.4(6.54)
7.49(3.4)	109(10.1)	95.7(8.89)	88.6(8.23)	74.7(6.94)
7.93(3.6)	115(10.7)	101(9.41)	93.8(8.71)	79.1(7.35)
8.37(3.8)	122(11.3)	107(9.93)	99.0(9.20)	83.5(7.76)
8.81(4.0)	128(11.9)	113(10.5)	104(9.68)	87.9(8.17)
9.25(4.2)	134(12.5)	118(11.0)	109(10.2)	92.3(8.58)
9.70(4.4)	141(13.1)	124(11.5)	115(10.7)	96.7(8.99)
10.14(4.6)	147(13.7)	129(12.0)	120(11.1)	101(9.40)
10.58(4.8)	158(14.7)	135(12.5)	125(11.6)	106(9.80)
11.02(5.0)	172(16.0)	141(13.1)	130(12.1)	110(10.2)
11.46(5.2)	186(17.3)	146(13.6)	135(12.6)	114(10.6)
11.9(5.4)	200(18.6)	155(14.4)	141(13.1)	119(11.0)
12.34(5.6)	215(20.0)	167(15.5)	146(13.6)	123(11.4)

12.78(5.8)	231(21.5)	179(16.6)	153(14.3)	128(11.8)
13.22(6.0)	247(23.0)	192(17.8)	164(15.3)	132(12.3)

- m : Total refrigerant charge in the system
- A : Minimum required room area
- Calculated in accordance with UL 60335-2-40 Annex GG
- **IMPORTANT:** It's mandatory to either follow the table above or follow the federal, state, and/or local regulations regarding the minimum room area allowed for the total refrigerant charge in the system.
- The actual refrigerant charge shall be per the room size within which the refrigerant-containing parts are installed.
- The ventilation machinery and outlets shall be operating adequately and not obstructed.
- If an indirect refrigerating circuit is being used, the secondary circuit shall be checked for the presence of refrigerant.
- Marking the equipment shall continue to be visible and legible. Markings and signs that are illegible shall be corrected.
- Refrigerating pipe or components shall be installed in a position where they are unlikely to be exposed to any substance that may corrode refrigerant-containing components unless the components are constructed of materials that are inherently resistant to being corroded or are suitably protected against being so corroded.

⚠ CAUTION

- The minimum installation height of the indoor unit is 7.2ft (2.2 m) for ceiling.

Do not install the air conditioner in the following places.

- Place where there is mineral oil or arsenic acid. Resin parts flame and the accessories may drop or water may leak. The capacity of the heat exchanger may be reduced or the air conditioner may be out of order.
- A place exposed to mineral oil, oil vapor or a cooking area where there is spray (If oil adheres to the heat exchanger, performance degradation, spray or condensation scattering may occur. If oil adheres to a plastic component, the component may deform or get damaged. Such issues may result in a system failure or refrigerant leak.)
- A place with aromatic diffusers, aromatherapy, scented candles or perfumes as the chemicals may react to the product's materials and may result in system failure or refrigerant leaks.
- The place where corrosive gas such as sulphuric acid gas is generated from the vent pipe or air outlet.
- The copper pipe or connection pipe may corrode, and the refrigerant may leak.
- The place where there is a machine that generates electromagnetic waves. The air conditioner may not operate normally due to the control system.

- The place where there is a danger of existing combustible gas, carbon fiber or flammable dust.
- The place that thinner or gasoline is handled. Gas may leak and it may cause fire.
- The place that is close to heat sources.
- Do not use the indoor unit for the preservation of food items, plants, equipment, and artwork. This may cause deterioration of their quality.
- Do not install the indoor unit if it has any drainage problems.

Space requirements for installation

Construction Standard for Inspection Hole

- 1 In the case the ceiling is lay-in tile, an inspection hole is not needed.
- 2 In case, the ceiling is the plasterboard, the inspection hole depends on the Inside height of the ceiling.
 - a Height is more than 1.64ft (0.5m) : Only "B" [Inspection for PBA] is applied.
 - b Height is less than 1.64ft (0.5m) : Both "A"&"B" are applied.
 - c "A"&"B" are inspection holes .

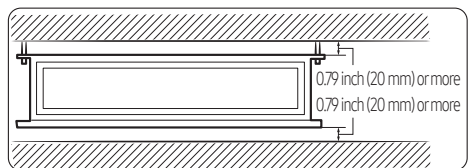
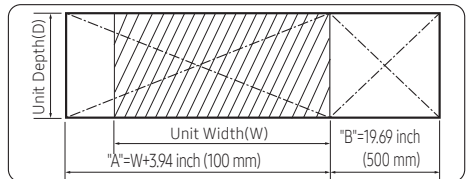

- You must have 0.79 inch (20 mm) or more space between the ceiling and the bottom of the indoor unit. Otherwise, the noise from the vibration of the indoor unit may bother the user. When the ceiling is under construction, the hole for check-up must be made to take service, clean and repair the unit.
- If you install the cassette or duct type indoor unit on the ceiling with humidity over 80%, you must apply an extra 0.39 inch (10mm) of polyethylene foam or other insulation with a similar material on the bottom of the indoor unit.

Installation Procedure

Indoor unit dimensions

AC009DNLD CG/AC012DNLD CG

Unit : inch(mm)

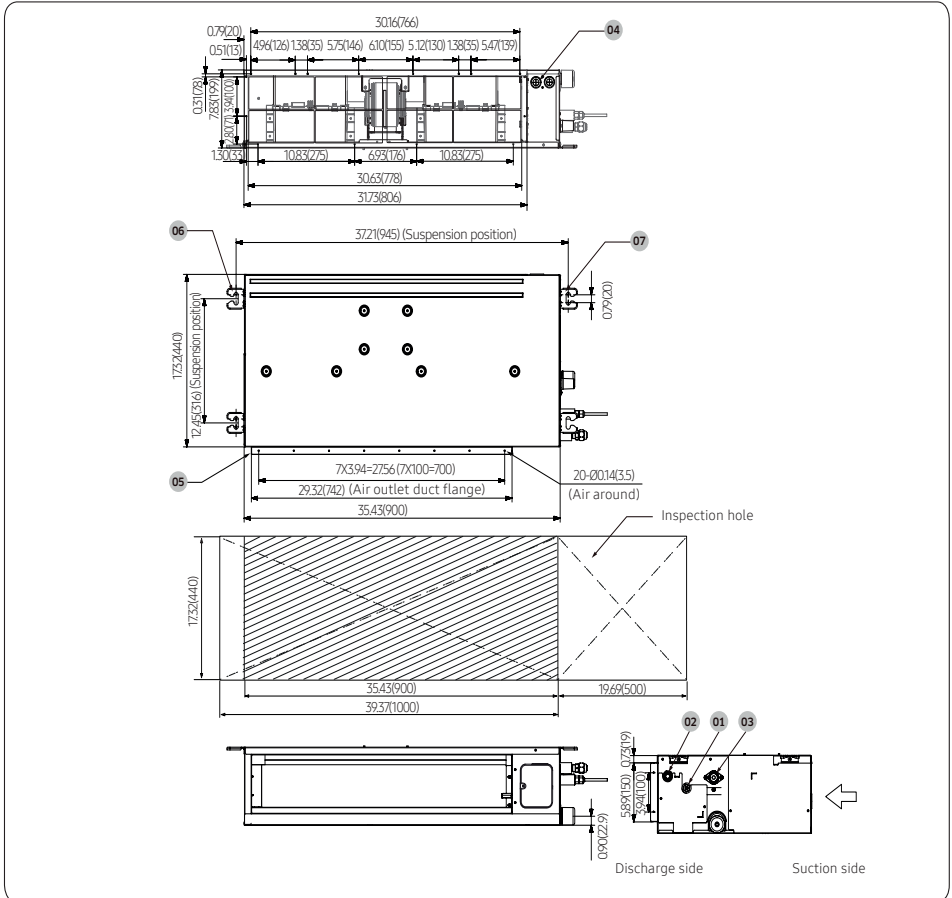

No.	Name	Description
01	Liquid pipe connection	Ø1/4 inch (6.35 mm)
02	Gas pipe connection	Ø3/8 inch (9.52mm)
03	Drainpipe connection	3/4 inch [OD 1.05 inch (26.67 mm)]
04	Power supply connection	
05	Air discharge flange	
06	Suction flange	Air filter
07	Hook	M8-M10

AC018DNLDCC

Unit : inch(mm)

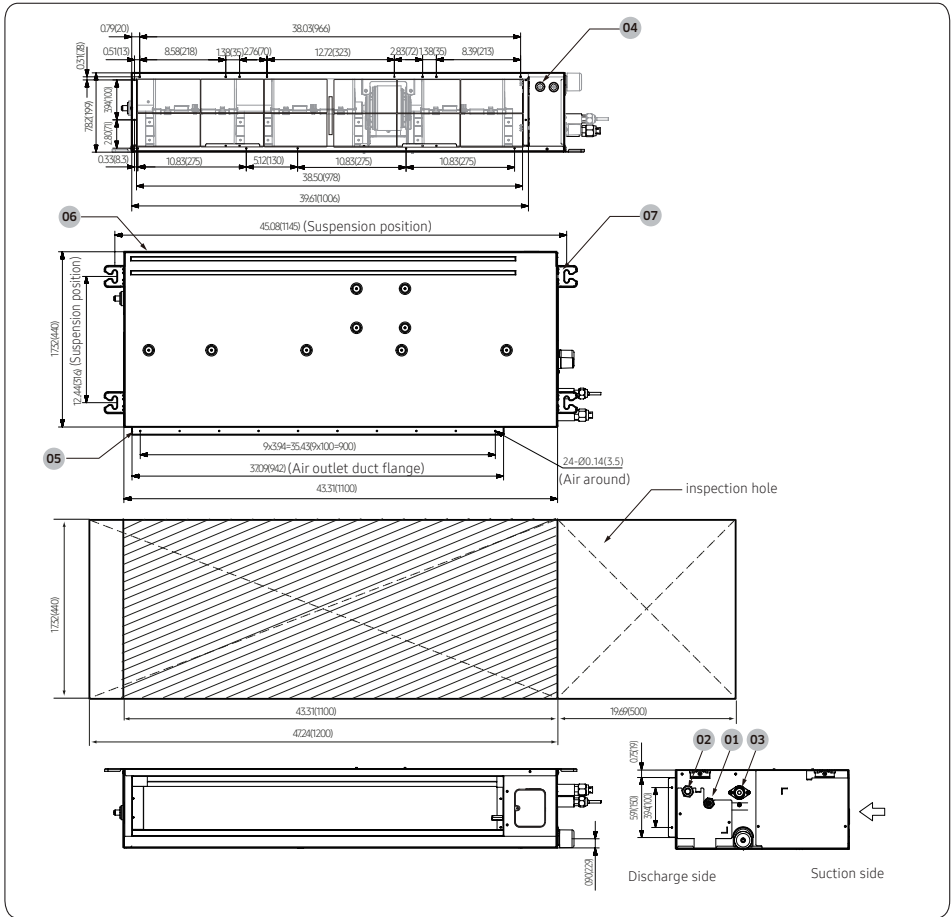

No.	Name	Description
01	Liquid pipe connection	Ø1/4 inch (6.35 mm)
02	Gas pipe connection	Ø1/2 inch (12.70 mm)
03	Drainpipe connection	3/4 inch [OD 1.05 inch (26.67 mm)]
04	Power supply connection	
05	Air discharge flange	
06	Suction flange	Air filter
07	Hook	M8~M10

Installation Procedure

Installation Procedure

AC009DNHDCG/AC012DNHDCG

Unit : inch(mm)

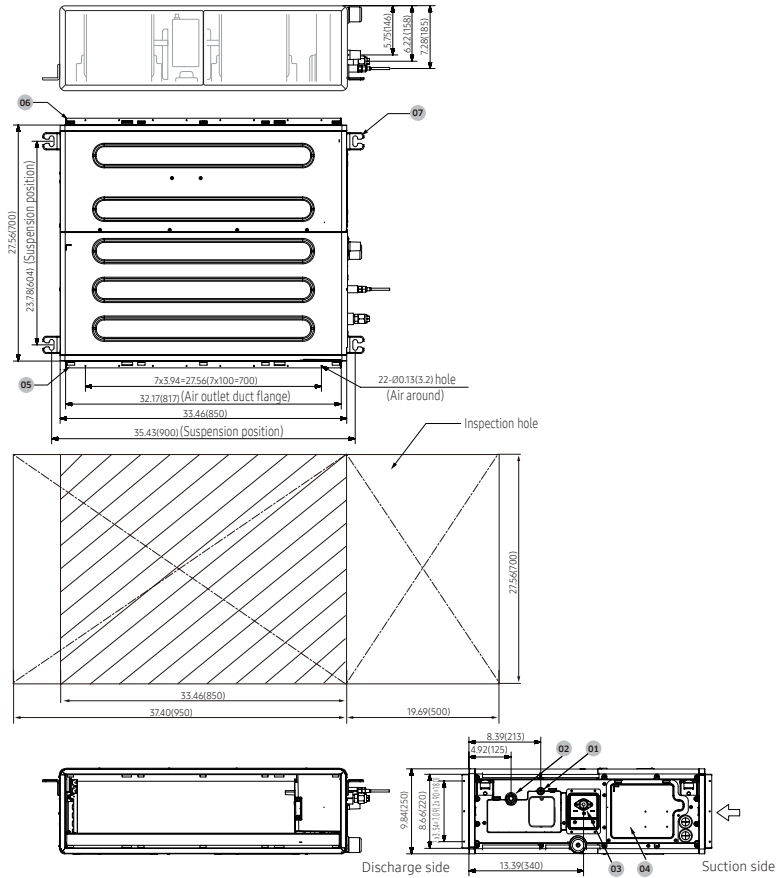

No.	Name	Description
01	Liquid pipe connection	Ø1/4 inch (6.35 mm)
02	Gas pipe connection	Ø3/8 inch (9.52 mm)
03	Drainpipe connection	3/4 inch [OD 1.05 inch (26.67 mm)]
04	Power supply connection	
05	Air discharge flange	
06	Suction flange	
07	Hook	M8~M10

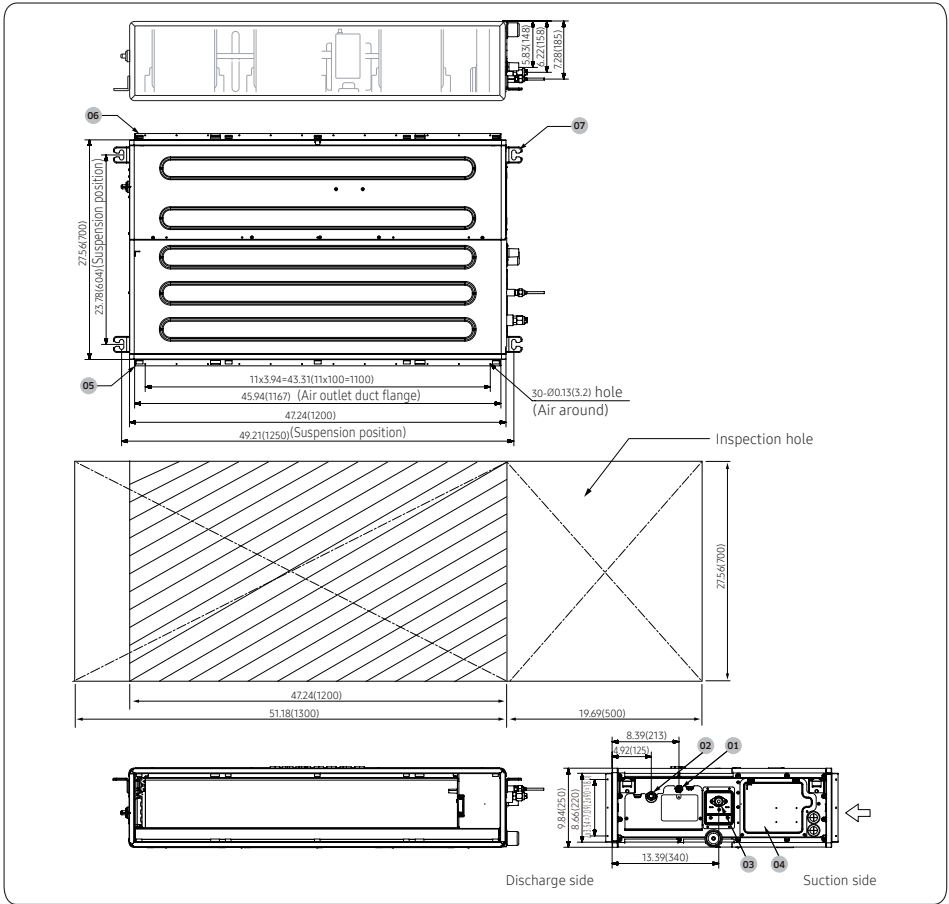

No.	Name	Description	
		AC018DNHDCG	AC024DNHDCG
01	Liquid pipe connection	Ø1/4 inch (6.35 mm)	
02	Gas pipe connection	Ø1/2 inch (12.70mm)	Ø5/8 inch (15.88 mm)
03	Drainpipe connection	3/4 inch [OD 1.05 inch (26.67 mm)]	
04	Power supply connection		
05	Air discharge flange		
06	Suction flange		
07	Hook	M8-M10	

Installation Procedure

AC030DNHDCG/AC036DNHDCG/AC048DNHDCG

Unit : inch(mm)

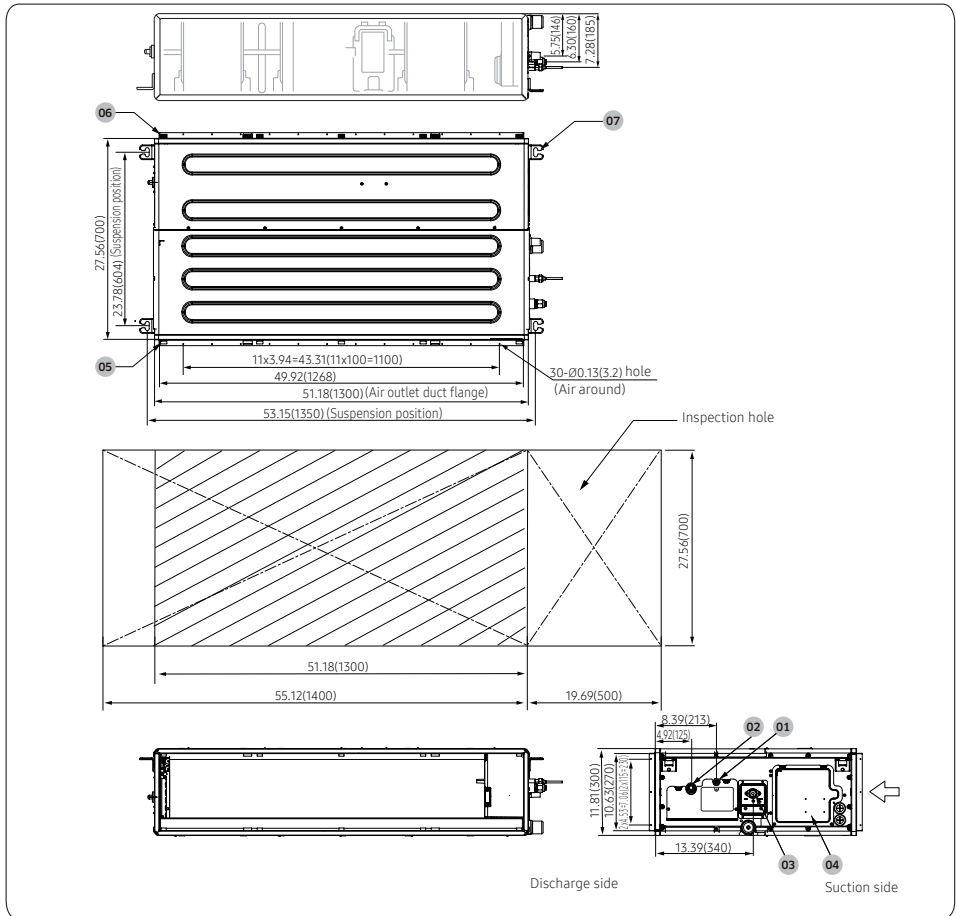

No.	Name	Description
01	Liquid pipe connection	Ø3/8 inch (9.52 mm)
02	Gas pipe connection	Ø5/8 inch (15.88 mm)
03	Drainpipe connection	3/4 inch [OD 1.05 inch (26.67 mm)]
04	Power supply connection	
05	Air discharge flange	
06	Suction flange	
07	Hook	M8-M10

Step 3 Optional: Insulating the body of the indoor unit

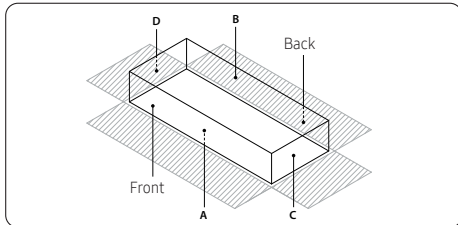

Thickness: more than 0.39 inch(10mm)

Indoor Unit	AC009DNLD CG AC012DNLD CG	AC018DNLD CG
		35.43X17.32X7.83 (900X440X199)
A	35.43X7.83 (900X199)	43.31X7.83 (1100X199)
B	35.43X7.83 (900X199)	43.31X7.83 (1100X199)
C	17.32X7.83 (440X199)	17.32X7.83 (440X199)
D	17.32X7.83 (440X199)	17.32X7.83 (440X199)
Front/ Back	Insulate the front and back sides in proper size at the same time when insulating the suction duct and discharge duct.	

Unit: inch(mm)

Indoor Unit	AC009DNHDCG AC012DNHDCG	AC018DNHDCG AC024DNHDCG	AC030DNHDCG AC036DNHDCG AC048DNHDCG
		33.46X27.56X9.84 (850X700X250)	47.24X27.56X9.84 (1200X700X250)
A	33.46X27.56 (850X700)	47.24X27.56 (1200X700)	51.18X27.56 (1300X700)
B	33.46X27.56 (850X700)	47.24X27.56 (1200X700)	51.18X27.56 (1300X700)
C	27.56X9.84 (700X250)	27.56X9.84 (700X250)	27.56X11.81 (700X300)
D	27.56X9.84 (700X250)	27.56X9.84 (700X250)	27.56X11.81 (700X300)
Front/ Back	Insulate the front and back sides in proper size at the same time when insulating the suction duct and discharge duct.		

Unit: inch(mm)

NOTE

- Insulate the end of the pipe and some curved areas by using a separate insulator.
- Insulate the discharge and suction part at the same time as you insulate the connection duct.
- If you install a duct type indoor unit on the ceiling with humidity over 80%, you must apply an extra 0.39 inch (10 mm) of polyethylene foam or other insulation with similar material on the body of the indoor unit.

Step 4 Installing the indoor unit

When deciding on the location of the air conditioner with the owner, the following restrictions must be considered.

- 1 Place the pattern sheet on the ceiling at the spot where you want to install the indoor unit.

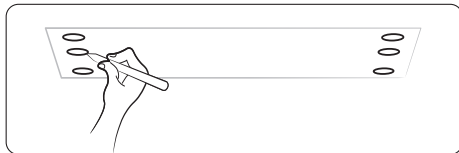

NOTE

- Since the diagram is made of paper, it may shrink or stretch slightly due to temperature or humidity. For this reason, before drilling the holes maintain the correct dimensions between the markings.
- 2 Insert bolt anchors. Use existing ceiling supports or construct a suitable support as shown in the figure.

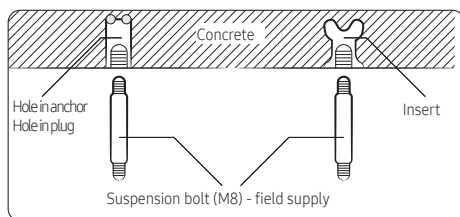

Installation Procedure

3 Install the suspension bolts depending on the ceiling type.

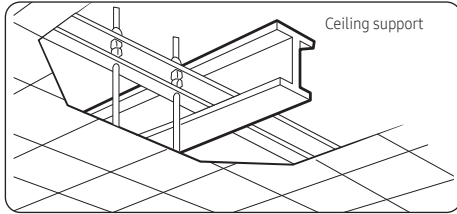

CAUTION

- Ensure that the ceiling is strong enough to support the weight of the indoor unit. Before hanging the unit, test the strength of each attached suspension bolt.
- If the length of the suspension bolt is more than 4.92 ft (1.5m), it is required to prevent vibration.
- If this is not possible, create an opening on the false ceiling to be able to use it to perform the required operations on the indoor unit.

4 Screw eight nuts to the suspension bolts making space for hanging the indoor unit.

NOTE

- You must install all the suspension rods.
- 5 Hang the indoor unit to the suspension bolts between two nuts.

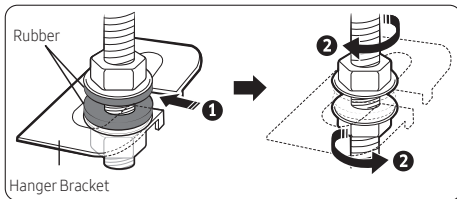

CAUTION

- Piping must be laid and connected inside the ceiling when suspending the unit. If the ceiling is already constructed, lay the piping into position for connection to the unit before placing the unit inside the ceiling.
- 6 Screw the nuts to suspend the unit.
- 7 Adjust the level of the unit by using a measurement plate for all 4 sides.

CAUTION

- For proper condensate drainage, give a 0.118 inch (3mm) slant to the left or right side of the unit which will be connected to the drain hose, as shown in the figure. Make a tilt when you wish to install the drain pump, too.

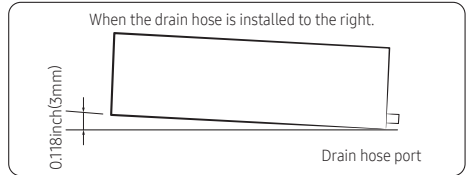

- When installing the indoor unit, make sure it is not tilted toward the front or back side.

CAUTION

- You can modify the air intake as shown in the image below.
 - Noise will increase by 3~6 dB(A) when the air flow enters from the bottom side (Only for AC***DNLDCG indoor unit product).
- 1 Disassemble 6 screws and replace the frame.
- Please put the image before work.
 - Please check screw Q'ty.

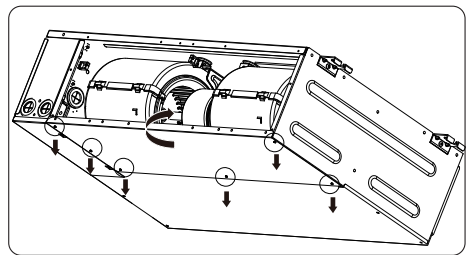

2 Assemble 6 screws.

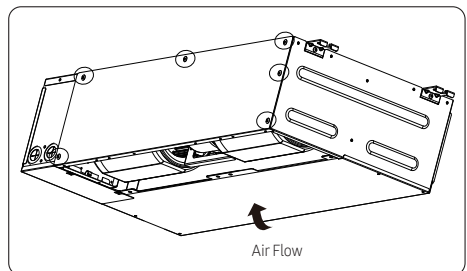

Step 5 Purging inert gas from the indoor unit

From the factory, the unit is supplied and set with a pre-charge of nitrogen gas. Therefore, all inert gas must be purged before connecting the assembly piping.

⚠ CAUTION

- Be careful not to damage the Wi-Fi cover when removing Flare Nut.

Unscrew the pinch pipe at the end of each refrigerant pipe.

Result : All inert gas escapes from the indoor unit.

AC***DNLDG

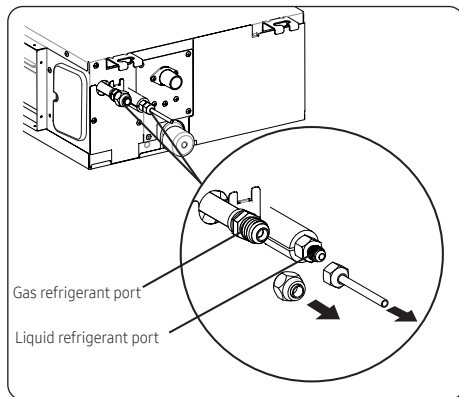

AC***DNHDCG

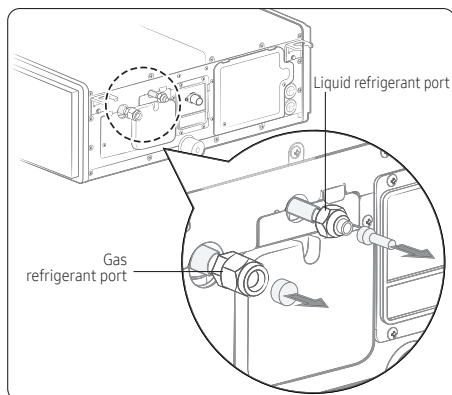

📖 NOTE

- The designs and shapes are subject to change according to the model.
- To prevent dirt or foreign objects from getting into the pipes during installation, do NOT remove the pinch pipe completely until you are ready to connect the piping.

⚠ CAUTION

- Connect the indoor and outdoor units using pipes with flared connections (not supplied). For the lines, use insulated, unwelded, degreased and deoxidized copper pipe (Cu DHP type to ISO 1337 or UNI EN 12735-1). Operating pressure depends on outdoor unit specifications. Check the outdoor unit installation manual.
- For sizing and limits (height difference, line length, max. bends, refrigerant charge, etc.) see the outdoor unit installation manual.
- All refrigerant connections must be accessible, to permit either unit maintenance or removing it completely.
- If the pipes require brazing, ensure that OFN (Oxygen Free Nitrogen) is flowing through the system.
- The nitrogen blowing pressure range is 0.02 ~ 0.05MPa(2.9 to 7.3 psi).

Step 6 Cutting and flaring the pipes

- Make sure that you have the required tools available. (pipe cutter, reamer, flaring tool and pipe holder)
- If you wish to shorten the pipes, cut them with a pipe cutter, taking care to ensure that the cut edge remains at a 90° angle with the side of the pipe. Refer to the illustrations below for examples of edges cut correctly and incorrectly.

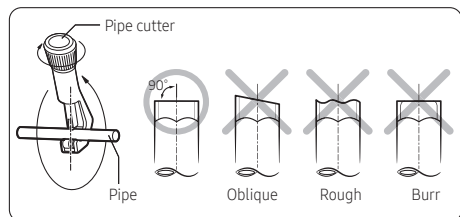

- To prevent any gas from leaking out, remove all burrs at the cut edge of the pipe, using a reamer.

Installation Procedure

4 Slide a flare nut onto the pipe and modify the flare.

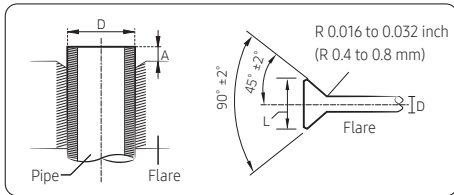

Outer Diameter (D)	Depth (A)	Flare dimension (L)
Ø1/4 (6.35)	0.051 (1.3)	0.34~0.36 (8.7~9.1)
Ø3/8 (9.52)	0.071 (1.8)	0.50~0.52 (12.8~13.2)
Ø1/2 (12.70)	0.079 (2.0)	0.64~0.65 (16.2~16.6)
Ø5/8 (15.88)	0.087 (2.2)	0.76~0.78 (19.3~19.7)
Ø3/4(19.05)	0.087 (2.2)	0.93~0.94 (23.6~24.0)

Unit: inch(mm)

5 Check that the flaring is correct, refer to the illustrations below for examples of incorrect flaring.

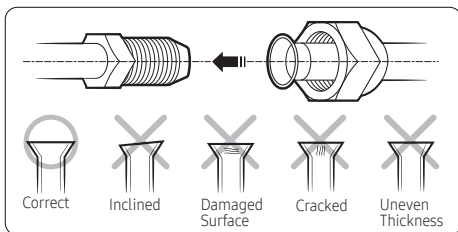

CAUTION

- If the pipes require brazing, ensure that OFN (Oxygen Free Nitrogen) is flowing through the system.
- The Nitrogen blowing pressure range is 0.02 ~ 0.05MPa.

Step 7 Connecting the assembly pipes to the refrigerant pipes

There are two refrigerant pipes of different diameters :

- A smaller one for the liquid refrigerant
 - A larger one for the gas refrigerant
 - The inside of copper pipe must be clean & has no dust
- 1 Remove the pinch pipe on the pipes and connect the assembly pipes to each pipe, tightening the nuts, first manually and then with a torque wrench, a spanner applying the following torque.

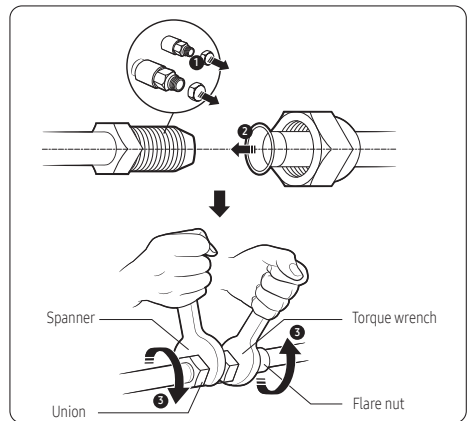

Outer Diameter		Torque	
mm	inch	N•m	lbf.ft
Ø6.35	1/4	14 to 18	10.3 to 13.3
Ø9.52	3/8	34 to 42	25.1 to 31.0
Ø12.70	1/2	49 to 61	36.1 to 45.0
Ø15.88	5/8	68 to 82	50.2 to 60.5
Ø19.05	3/4	100 to 120	73.8 to 88.5

(1 N•m=10 kgf•cm)

NOTE

- If the pipes must be shortened refer to page 17, **Step 6 Cutting and flaring the pipes**
 - Tighten the nuts to the specified torques. If overtightened, the nuts could be broken so refrigerant may leak.
- 2 Be sure to use an insulator that is thick enough to cover the refrigerant tube to protect the condensate water on the outside of the pipe from falling onto the floor and the efficiency of the unit will be better.
 - 3 Cut off any excess foam insulation.

- 4 Be sure that there are no cracks or waves on the bent area.
- 5 It would be necessary to double the insulation thickness [0.39 inch (10mm) or more] to prevent condensation even on the insulator when the installed area is warm and humid.
- 6 Do not use joints or extensions for the pipes that connect the indoor and outdoor units. The only permitted connections are those for which the units are designed.

⚠ CAUTION

- Be careful not to damage the Wi-Fi cover when removing Flare Nut.

AC***DNLDCG

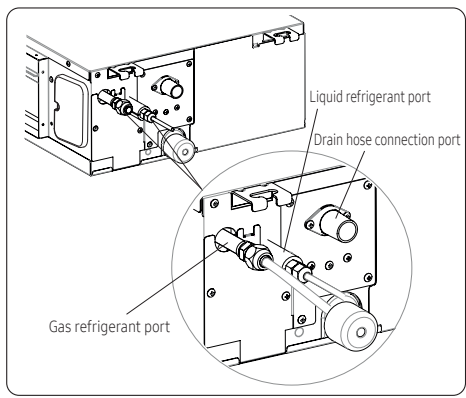

AC***DNHDCG

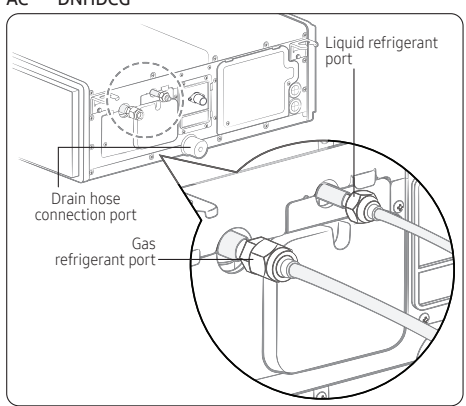

Step 8 Performing the gas leak test

To identify potential gas leaks in the indoor unit, inspect the connection area of each refrigerant pipe using a leak detector for R-32.

Before vacuuming and circulating the refrigerant gas, pressurize the whole system with nitrogen (using a cylinder with a pressure reducer) at a pressure of 4.0 MPa(594.7 psi) (gauge) to immediately detect leaks on the refrigerant fittings.

Make a vacuum for 15 minutes and pressurize the system with nitrogen.

AC***DNLDCG

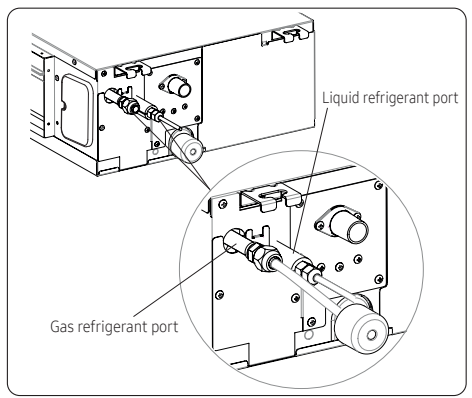

AC***DNHDCG

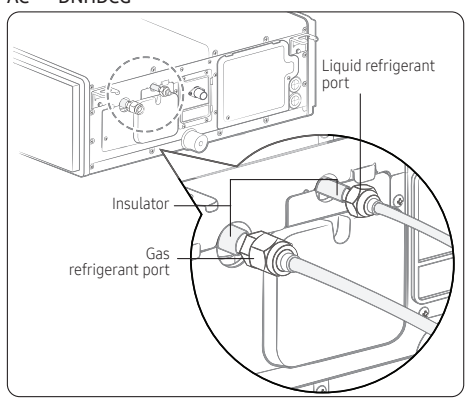

📄 NOTE

- The designs and shapes are subject to change according to the model.

Installation Procedure

Step 9 Insulating the refrigerant pipes

Once you have checked that there are no leaks in the system, you can insulate the piping and hose.

- 1 To avoid condensation problems, place Acrylonitrile Butadiene Rubber separately around each refrigerant pipe.

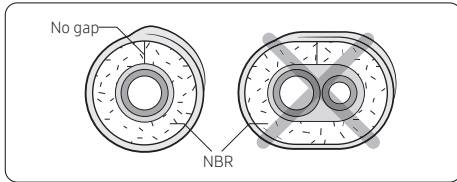

NOTE

- Always make the seam of pipes face upwards.
- 2 Wind insulating tape around the pipes and drain hose to avoid compressing the insulation too much.

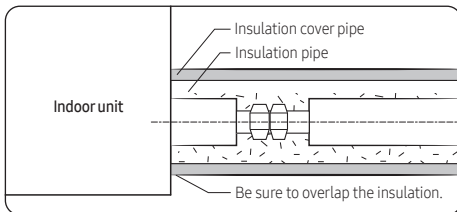

CAUTION

- Be sure to wrap the insulation tightly without any gaps.
- 3 Finish wrapping insulating tape around the rest of the pipes leading to the outdoor unit.
 - 4 The pipes and electrical cables connecting the indoor unit with the outdoor unit must be fixed to the wall with suitable ducts.

CAUTION

- Make sure that all refrigerant connections are accessible for easy maintenance and detachment.
- Install the insulation not to get wider and use the adhesives on the connection part of it to prevent moisture from entering.
- Wind the refrigerant pipe with insulation tape if it is exposed to outside sunlight.
- Install the refrigerant pipe respecting that the insulation does not get thinner on the bent part or hanger of pipe.
- Add additional insulation if the insulation plate gets thinner.

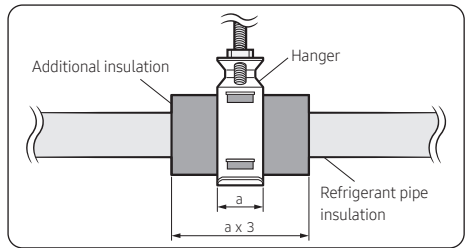

- 5 Select the insulation of the refrigerant pipe.
 - Insulate the gas side and liquid side pipe, noting the insulation thickness that must differ according to the pipe size.
 - Standard: Less than an indoor temperature of 86°F(30°C), with humidity at 85%. If installing in a high humidity environment, use one grade thicker insulator by referring to the table below. If installing in an unfavorable environment, use a thicker one.
 - The heat-resistance temperature of the insulator must be more than 248°F(120°C).

Pipe	Outer diameter		Insulation Type (Cooling, Heating)				Remarks
			General [86°F(30°C), 85%]		High humidity [86°F(30°C), over 85%]		
			EPDM, NBR				
			mm	inch	mm	inch	
Liquid pipe	6.35~9.52	1/4~3/8	9	3/8	9	3/8	The internal temperature is higher than 248°F(120°C)
	12.7~50.80	1/2~2	13	1/2	13	1/2	
Gas pipe	6.35	1/4	13	1/2	19	3/4	
	9.52~25.4	3/8~1	19	3/4	25	1	
	28.58~44.45	1 1/8~1 3/4	19	3/4	32	1 1/4	
	50.8	2	25	1	38	1 1/2	

- When installing insulation in the places and conditions below, use the same insulation that is used for high humidity conditions.

<Geological condition>
High humidity locations such as shorelines, hot springs, lakes or riversides, and ridges (when part of the building is covered by earth and sand)
<Operation purpose condition>
Restaurant ceiling, sauna, swimming pool etc.
<Building construction condition>
Ceilings frequently exposed to moisture and cooling are not covered. For example, pipes installed in a corridor of a dormitory and studio or near an exit that opens and closes frequently. Places (where the pipes are installed) that are highly humid due to a lack of ventilation.

Installation Procedure

Step 10 Installing the drain hose and drain pipe

- 1 Push the supplied drain hose as far as possible over the drain socket.
- 2 Tighten the metal clamp as shown in the picture.

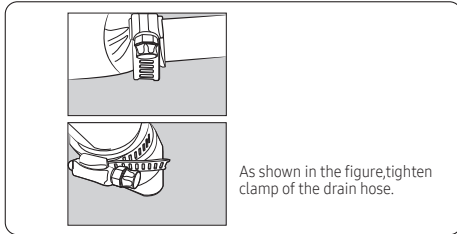

- 3 Wrap the supplied large sealing pad over the metal clamp and drain hose to insulate and fix it with clamps.
- 4 Insulate the complete drain piping inside the building (field supply).
If the drain hose cannot be sufficiently set on a slope, fit the hose with drain raising piping (field supply).
- 5 Push the drain hose up to insulation when connecting the drain hose to the drain socket.

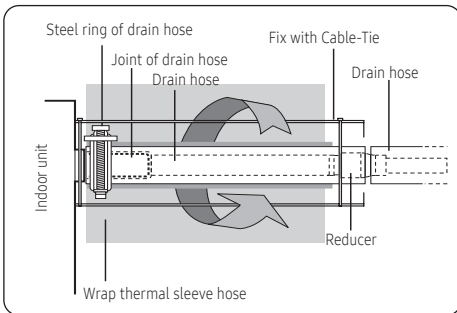

With the drain pump

- 1 The drain pipe should be installed within 11.81inch(300mm) to 21.65inch(550mm) from the flexible hose and then lift down 0.79inch(20mm) or more.
- 2 Install the horizontal drainpipe and copper pipe at an incline of at least 1/100, and attach a full-thread bolt hanger every 39.37 to 59.05 inches (1 to 1.5 m) along the pipe to fix it in place.
- 3 Install the air vent in the horizontal drainpipe to prevent water from flowing back to the indoor unit.
 - Place the drainpipe at a height of 11.81 to 21.65 inches (300 to 550 mm) within 11.81 inches (300 mm) from the drain hose, and install it with a drop-off of at least 0.79 inch (20 mm).
 - If the slope of the horizontal drainpipe is less than 1/100, install an air vent with a height of at least 7.87 inches (200 mm) or a backflow prevention vent at each drain inlet, to ensure smooth condensate flow.
 - If the slope of the drainpipe is less than 1/100 and no air vent is installed, the air conditioner will not operate properly because condensate is not discharged.
 - If an air vent with a of height less than 7.87 inches(200 mm) or a vent without backflow prevention functionality is installed, the drainpipe may become clogged, causing water to leak through the vent.

NOTE

- You may not need to install it if there is a proper slope in the horizontal drainpipe.
- 4 The flexible hose should not be installed in a upward position, as it may cause water to flow back to the indoor unit.

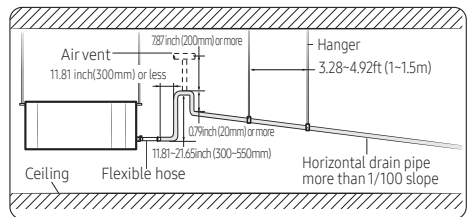

Centralized drainage with the drain pump

NOTE

- If a concentrated drain pipe is installed, refer to the figure below.

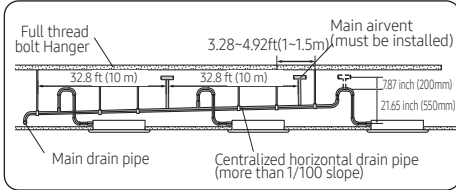

- If 3 or more units are installed, install a main air vent in front of the farthest indoor unit from the main drain pipe.
- To prevent water from flowing back to indoor units, install an individual air vent at the top of each indoor unit.
 - The air vents should be T or 7 shaped to prevent dust or foreign substances from entering.
 - You may not need to install an air vent if the horizontal drain pipe has a proper slope.

① If the centralized horizontal drain pipe is 32.8 ft (10 m) or longer, install an air vent every 32.8 ft (10 m).

- If the centralized horizontal drain pipe is shorter than 32.8 ft (10 m), install an air vent in front of the indoor unit farthest from the main drain pipe.

② Install the centralized horizontal drain pipe at an incline of at least 1/100, and attach a full-thread bolt hanger every 3.28 to 4.92 ft (1 to 1.5 m) along the pipe to fix it in place.

- If the slope of the centralized horizontal drain pipe is less than 1/100, install an air vent with a height of at least 7.87 inches (200 mm) or a backflow prevention vent at each drain inlet, to ensure smooth condensate flow.
- If the slope of the centralized horizontal drain pipe is less than 1/100 and no air vent is installed, the air conditioner may not operate properly because condensate is not discharged.
- If an air vent with a height less than 7.87 inches (200 mm) or a vent without backflow prevention functionality is installed, the drain pipe may become clogged, causing condensate to flow back through the vent.

Step 11 Performing the drainage test

Prepare a little water, about 2 liters.

- 1 Pour water into the base pan in the indoor unit as shown in the figure.
- 2 Confirm that the water flows out through the drain hose.

AC***DNLDCCG

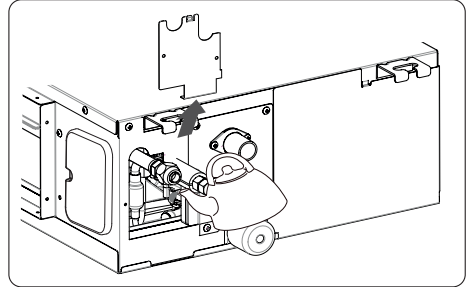

AC***DNHDCG

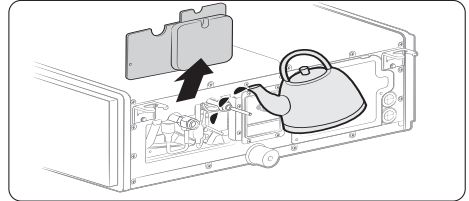

※The designs and shapes are subject to change according to the model.

- 3 Confirm that the water flows out through the drain hose.
- 4 When the drain pump is installed, operate the unit in cooling mode and check a drain pump pumping.
- 5 Check drain water drops at the end of the drainpipe.
- 6 Make sure there is no water leak in the drainage.
- 7 Reinstall the side cover plate.

Installation Procedure

Step 12 Optional: Installing the external controller

- 1 Fix the case at with bolts on the side of the control box in the indoor unit.(See the picture).
- 2 Attach the external controller PCB to the case in the control box of the indoor unit.
- 3 Connect the harness wires.

Accessories (External controller : MIM-B14 / MIM-B14U)

External Controller	PCB Case
Wire Harness(4P)	Wire Harness(2P)
Screw	

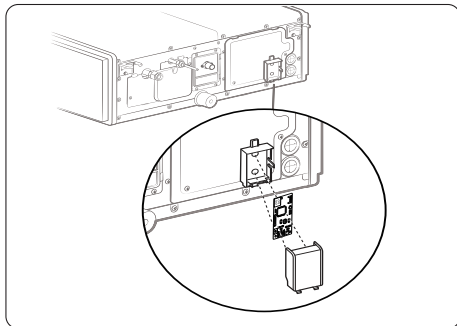

Wiring work

Selecting compressed ring terminal

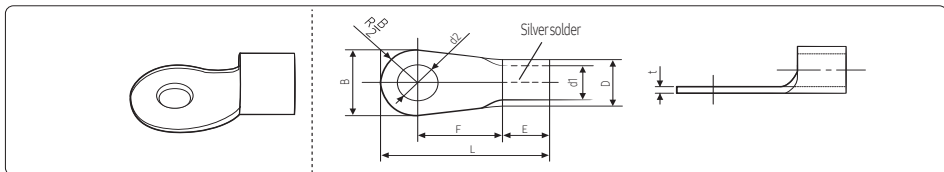

Nominal dimensions for cable [Inch ² (mm ²)]		0.002 (1.5)		0.003 (2.5)		0.006 (4)	
Nominal dimensions for screw [Inch (mm)]		0.15 (4)		0.15 (4)		0.15 (4)	
B	Standard dimension [Inch (mm)]	0.25 (6.6)		0.31 (8.0)		0.25 (6.6)	
	Allowance [Inch (mm)]	±0.007 (±0.2)		±0.007 (±0.2)		±0.007 (±0.2)	
D	Standard dimension [Inch (mm)]	0.13 (3.4)		0.16 (4.2)		0.22 (5.6)	
	Allowance [Inch (mm)]	+0.011 (+0.3) -0.007 (-0.2)		+0.011 (+0.3) -0.007 (-0.2)		+0.011 (+0.3) -0.007 (-0.2)	
d1	Standard dimension [Inch (mm)]	0.06 (1.7)		0.09 (2.3)		0.13 (3.4)	
	Allowance [Inch (mm)]	±0.007 (±0.2)		±0.007 (±0.2)		±0.007 (±0.2)	
E	Min. [Inch (mm)]	3/16 (4.1)		1/4 (6)		1/4 (6)	
F	Min. [Inch (mm)]	1/4 (6)		1/4 (6)		1/4 (6)	
L	Max. [Inch (mm)]	5/8 (16)		3/4 (17.5)		3/4 (20)	
d2	Standard dimension [Inch (mm)]	0.16 (4.3)		0.16 (4.3)		0.16 (4.3)	
	Allowance [Inch (mm)]	+0.007 (+0.2) 0 (0)		+0.007 (+0.2) 0 (0)		+0.007 (+0.2) 0 (0)	
t	Min. [Inch (mm)]	0.02 (0.7)		0.03 (0.8)		0.035 (0.9)	

Step 13 Connecting the power and communication cables

⚠ CAUTION

- Always remember to connect the refrigerant pipes before performing the electric connections. When disconnecting the system, always disconnect the electric cables before disconnecting the refrigerant pipes.

⚠ CAUTION

- Always connect the air conditioner to the grounding system before performing the electric connections. Use a crimp ring terminal at the end of each wire.

The indoor unit is powered through the outdoor unit using a H05RN-F (60245 / IEC57) connection cable (or a more powerful model), with insulation in synthetic rubber and a jacket in polychloroprene (neoprene), following the requirements specified in the standard EN 60335-2-40.

- Remove the screw on the electrical component box and remove the cover plate.
- Route the connection cord through the side of the indoor unit and connect the cable to the terminals refer to the figure below.
- Route the other end of the cable to the outdoor unit through the ceiling & the hole in the wall.
- Reassemble the electrical component box cover, carefully tightening the screw.

AC***DNLDGC

AC***DNHDCC

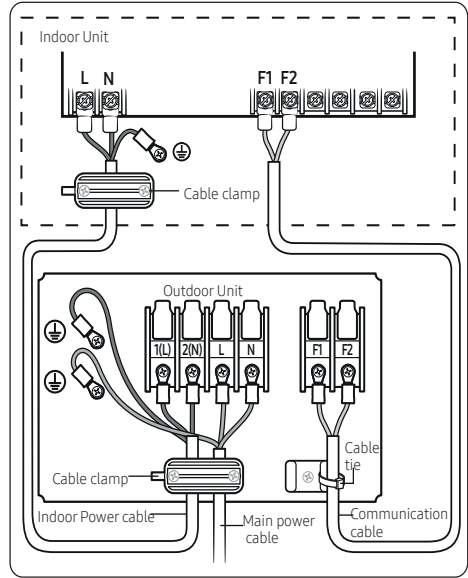

📖 NOTE

- The Terminal Block of the outdoor unit may be different from the diagram depending on the model. Refer to the manual of the outdoor unit for the configuration of the terminal block of the outdoor unit.

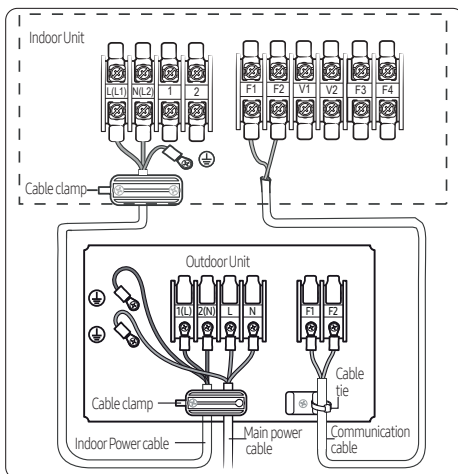

Indoor power supply		
Power supply	Max/Min(V)	Indoor power cable
208 to 230V, 60 Hz	±10%	AC***DNLDGC : AWG18↑ AC***DNHDCC : AWG14↑, 3 wires
Communication cable		
AWG18↑, 2 wires		

Installation Procedure

AC***DNLDCG

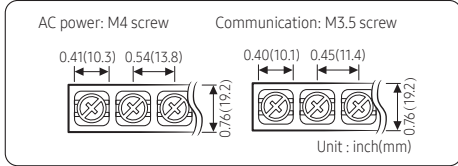

AC***DNHDCG

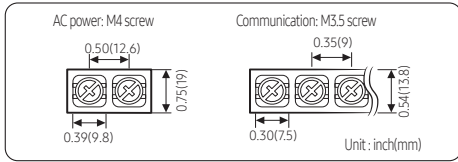

Tightening torque lbf·ft (kgf·cm)

M3.5	0.58 to 0.87 (8.0 to 12.0)
M4	0.87 to 1.30 (12.0 to 18.0)

- 1 N·m = 10 kgf·cm

- Power supply cords of parts of appliances for outdoor use shall not be lighter than polychloroprene sheathed flexible cords.

–Code designation

[1-phase] IEC: 60245 IEC 57 / CENELEC: H05RN-F grade or more

- Be sure to run the power supply cable and the communication cable through the electrical conduit as seen in the picture.

AC***DNLDCG

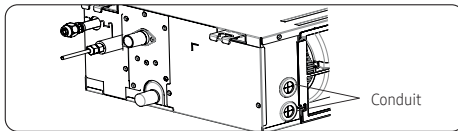

AC***DNHDCG

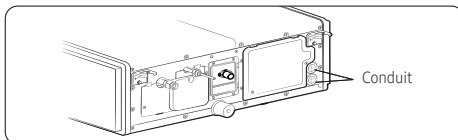

⚠ CAUTION

- Be sure not to put your finger into the conduit.
- Since it has an external power supply, refer to the outdoor unit installation manual for MAIN POWER.

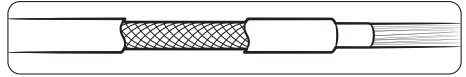

⚠ CAUTION

- When installing the indoor unit in a computer room or a server room, use the double shielded communication cable (tape aluminum / polyester braid + copper) of FROHH2R or LiYCY type.

Step 14 Setting additional functions of wired remote control

Automatic Air-Volume (This function can't be used at AC***DNLDGC model)

An Automatic Air-Volume function must be performed for each indoor unit with the wired remote control attached.

With its BLDC motor, you can use smart adjust the indoor unit fan speed depending on the installation condition.

If the duct is long so the external static pressure is high, or the duct is short so the external static pressure is low, the Automatic Air Volume will automatically adjust the supply air flow to the rate air flow rate. Push the  button to enter the automatic air volume setting screen.

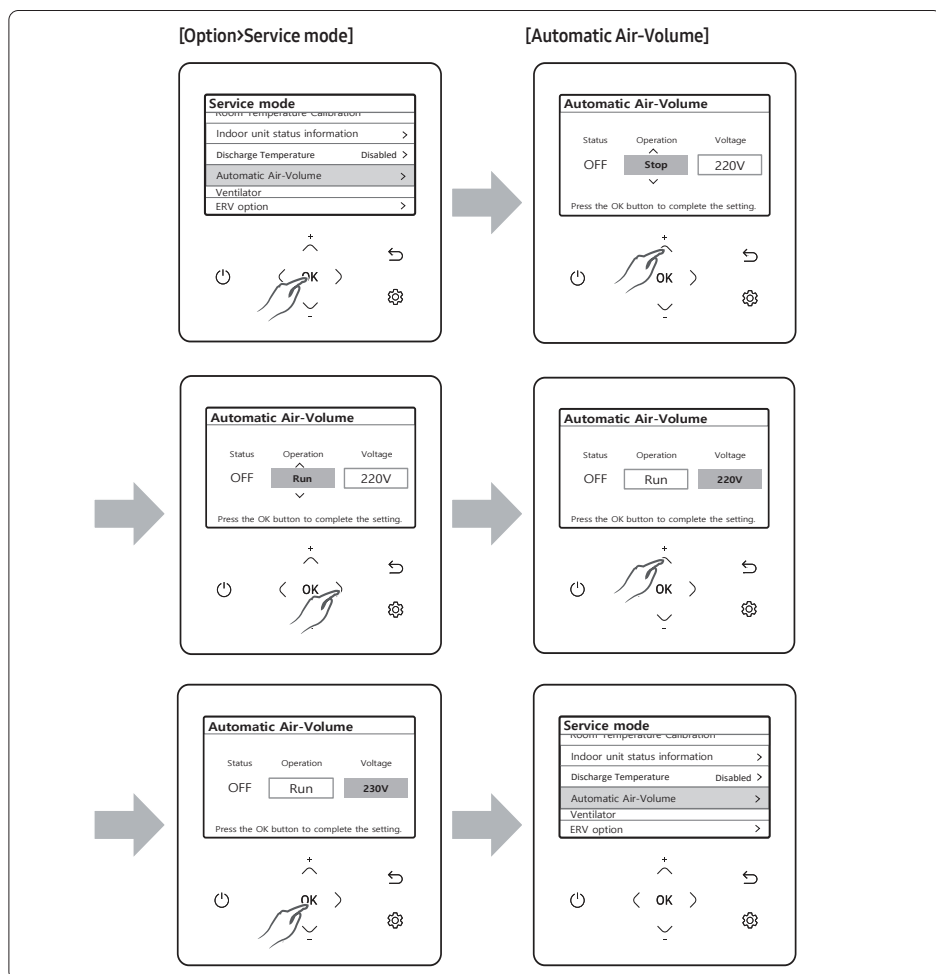

Installation Procedure

External Static Pressure (ESP) setting for phase control motor

With its phase control motor, you can adjust the indoor unit fan speed depending on the installation condition. If the external static pressure is high so that the duct becomes longer or if the external static pressure is low so that the duct becomes shorter, adjust the fan speed by referring to the following table.

Model		AC009DNLDGC
Static Pressure		Option Code for Indoor Unit
inWg	mmAq	
0.01<P _s ≤0.06	0.3<P _s ≤1.5	01C3FC-1C543A-271A23-372000
0.06<P _s ≤0.1	1.5<P _s ≤2.6	01C3FC-1C549E-271A23-372000
0.1<P _s ≤0.16	2.6<P _s ≤4.0	01C3FC-1C55E3-271A23-372000
0.16<P _s ≤0.20	4.0<P _s ≤5.0	01C3FC-1C5925-271A23-372000
0.20<P _s ≤0.24	5.0<P _s ≤6.0	01C3FC-1C5968-271A23-372000

Model		AC012DNLDGC
Static Pressure		Option Code for Indoor Unit
inWg	mmAq	
0.01<P _s ≤0.06	0.3<P _s ≤1.5	01C3FC-1C54DF-272328-372000
0.06<P _s ≤0.1	1.5<P _s ≤2.6	01C3FC-1C5923-272328-372000
0.1<P _s ≤0.16	2.6<P _s ≤4.0	01C3FC-1C5975-272328-372000
0.16<P _s ≤0.20	4.0<P _s ≤5.0	01C3FC-1C59A8-272328-372000
0.20<P _s ≤0.24	5.0<P _s ≤6.0	01C3FC-1C59DA-272328-372000

Model		AC018DNLDGC
Static Pressure		Option Code for Indoor Unit
inWg	mmAq	
0.01<P _s ≤0.06	0.3<P _s ≤1.5	01C3EC-1C54FB-22343C-372000
0.06<P _s ≤0.1	1.5<P _s ≤2.6	01C3EC-1C583D-22343C-372000
0.1<P _s ≤0.16	2.6<P _s ≤4.0	01C3EC-1C5980-22343C-372000
0.16<P _s ≤0.20	4.0<P _s ≤5.0	01C3EC-1C59B2-22343C-372000
0.20<P _s ≤0.24	5.0<P _s ≤6.0	01C3EC-1C59F5-22343C-372000

Model		AC009DNHDCG
Static Pressure		Option Code for Indoor Unit
inWg	mmAq	
0.10<P _s ≤0.20	2.5<P _s ≤5	01B3FC-1C5422-271A23-372000
0.20<P _s ≤0.30	5<P _s ≤7.5	01B3FC-1C5495-271A23-372000
0.30<P _s ≤0.40	7.5<P _s ≤10.0	01B3FC-1C54EA-271A23-372000
0.40<P _s ≤0.50	10.0<P _s ≤12.5	01B3FC-1C588E-271A23-372000
0.50<P _s ≤0.60	12.5<P _s ≤15.0	01B3FC-1C5970-271A23-372000

Model		AC012DNHDCG
Static Pressure		Option Code for Indoor Unit
inWg	mmAq	
0.01<P _s ≤0.06	2.5<P _s ≤5	01B3FC-1C5443-272328-372000
0.06<P _s ≤0.1	5<P _s ≤7.5	01B3FC-1C54A7-272328-372000
0.1<P _s ≤0.16	7.5<P _s ≤10.0	01B3FC-1C54FC-272328-372000
0.16<P _s ≤0.20	10.0<P _s ≤12.5	01B3FC-1C589F-272328-372000
0.20<P _s ≤0.24	12.5<P _s ≤15.0	01B3FC-1C5981-272328-372000

Model		AC018DNHDCG
Static Pressure		Option Code for Indoor Unit
inWg	mmAq	
0.10<P _s ≤0.20	2.5<P _s ≤5	01B3FC-1C5459-2F343C-372020
0.20<P _s ≤0.30	5<P _s ≤7.5	01B3FC-1C54BD-2F343C-372020
0.30<P _s ≤0.40	7.5<P _s ≤10.0	01B3FC-1C5901-2F343C-372020
0.40<P _s ≤0.50	10.0<P _s ≤12.5	01B3FC-1C5954-2F343C-372020
0.50<P _s ≤0.60	12.5<P _s ≤15.0	01B3FC-1C5997-27343C-372020
0.60<P _s ≤0.70	15<P _s ≤17.5	01B3FC-1C59E9-2F343C-372020
0.70<P _s ≤0.80	17.5<P _s ≤20.0	01B3FC-1C5D2C-2F343C-372020



Model		AC024DNHDCG
Static Pressure		Option Code for Indoor Unit
inWg	mmAq	
0.10<P _s ≤0.20	2.5<P _s ≤5	01B3FC-1C545A-27484F-372020
0.20<P _s ≤0.30	5<P _s ≤7.5	01B3FC-1C54BE-27484F-372020
0.30<P _s ≤0.40	7.5<P _s ≤10.0	01B3FC-1C5902-27484F-372020
0.40<P _s ≤0.50	10.0<P _s ≤12.5	01B3FC-1C5955-27484F-372020
0.50<P _s ≤0.60	12.5<P _s ≤15.0	01B3FC-1C5998-27484F-372020
0.60<P _s ≤0.70	15<P _s ≤17.5	01B3FC-1C59EA-27484F-372020
0.70<P _s ≤0.80	17.5<P _s ≤20.0	01B3FC-1C5D2D-27484F-372020

Model		AC030DNHDCG
Static Pressure		Option Code for Indoor Unit
inWg	mmAq	
0.10<P _s ≤0.20	2.5<P _s ≤5	01B3FC-1C5405-275A66-372045
0.20<P _s ≤0.30	5<P _s ≤7.5	01B3FC-1C5459-275A66-372045
0.30<P _s ≤0.40	7.5<P _s ≤10.0	01B3FC-1C54AC-275A66-372045
0.40<P _s ≤0.50	10.0<P _s ≤12.5	01B3FC-1C54EF-275A66-372045
0.50<P _s ≤0.60	12.5<P _s ≤15.0	01B3FC-1C5912-275A66-372045
0.60<P _s ≤0.70	15<P _s ≤17.5	01B3FC-1C5954-275A66-372045
0.70<P _s ≤0.80	17.5<P _s ≤20.0	01B3FC-1C5987-275A66-372045

Model		AC036DNHDCG
Static Pressure		Option Code for Indoor Unit
inWg	mmAq	
0.10<P _s ≤0.20	2.5<P _s ≤5	01B3FC-1C5439-276975-372045
0.20<P _s ≤0.30	5<P _s ≤7.5	01B3FC-1C548C-276975-372045
0.30<P _s ≤0.40	7.5<P _s ≤10.0	01B3FC-1C54CE-276975-372045
0.40<P _s ≤0.50	10.0<P _s ≤12.5	01B3FC-1C55F1-276975-372045
0.50<P _s ≤0.60	12.5<P _s ≤15.0	01B3FC-1C5933-276975-372045
0.60<P _s ≤0.70	15<P _s ≤17.5	01B3FC-1C5965-276975-372045
0.70<P _s ≤0.80	17.5<P _s ≤20.0	01B3FC-1C59A6-276975-372045

Model		AC048DNHDCG
Static Pressure		Option Code for Indoor Unit
inWg	mmAq	
0.10≤Ps≤0.20	2.5≤Ps≤5	01B3FC-1C545A-278C9B-372045
0.20<Ps≤0.30	5<Ps≤7.5	01B3FC-1C54AD-278C9B-372045
0.30<Ps≤0.40	7.5<Ps≤10.0	01B3FC-1C54EF-278C9B-372045
0.40<Ps≤0.50	10.0<Ps≤12.5	01B3FC-1C5912-278C9B-372045
0.50<Ps≤0.60	12.5<Ps≤15.0	01B3FC-1C5954-278C9B-372045
0.60<Ps≤0.70	15<Ps≤17.5	01B3FC-1C5986-278C9B-372045
0.70<Ps≤0.80	17.5<Ps≤20.0	01B3FC-1C59C7-278C9B-372045

NOTE



-  represents E. S. P (External Static Pressure) range of factory setting.
 You don't have to adjust the fan speed separately if the external static pressure of the installation place is in . When it is out of , input the appropriate option code.
- If you input the inappropriate option code, an error may occur, or the air conditioner is out of order. The option code must be input correctly by the installation specialist or service agent.

EASY Tuning

If more cooling and heating airflow rate is wanted, or if the quieter operation set is wanted, the air conditioner can be tuned for comfort.

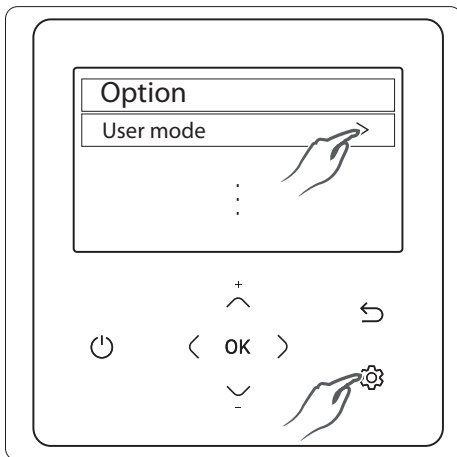
Indoor unit airflow rate for high, mid and low modes increases or decreases for +2 ~ -2 Steps with wired remote control.



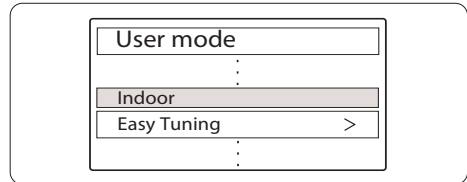

- Press the  button.
 (Main Menu) will be displayed, and you can press the []/[] buttons to select User mode.

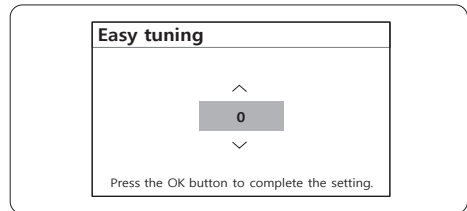

- Press the []/[] buttons to select Easy Tuning.



- Press the []/[] buttons to select Easy tuning value (-2,-1,0,1,2) tuning.

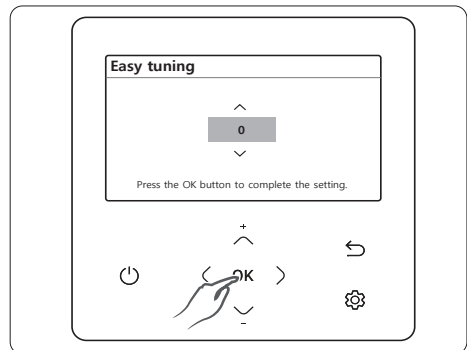

- Press the **OK** buttons to complete the Easy Tuning.

NOTE

- Easy tuning value
 - Default : 0, reflecting the status value of the indoor unit.
 - Range : -2/+2 (unit:1)
- Press the  button anytime during setup to exit without setting.
- When airflow is reduced using Easy Tuning, reduction in system performance is possible.

Installation Procedure

Step15 Optional : Setting the Emergency Temperature Output (ETO) function

CAUTION

- To deploy the ETO function, the MIM-B14 or MIM-B14U, an external contact interface module, must be installed in each indoor unit.
- To use the ETO function, should use S-NET Pro 2.
- The ETO is a concept of emergency operation of indoor units. If indoor unit 1 (main indoor unit) stops because of an error, indoor unit 2 (sub-indoor unit) starts to operate.
- Basically, indoor unit 2 operates in the previous mode. [For the first time operation, it starts in 24 °C (75 °F) Auto mode.]
- To set more detailed operation conditions for the indoor unit 2, use the S-net Pro 2.

Setting up the ETO

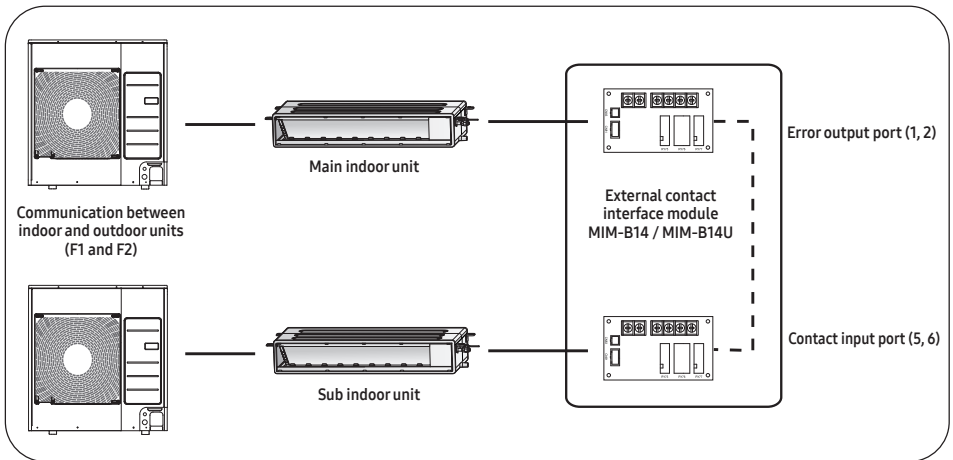

- 1 Main indoor unit
 - Disable the external contact control (Default).
 - Connect the S-net Pro 2 to F1 and F2.
 - Enable the ETO function and set the temperature and time.
- 2 Sub indoor unit
 - (Required) Enable the external contact control (with the installation option SEG14 - Reverse Control).
 - Connect the S-net Pro 2 to F1 and F2.
 - Enable the entrance control and set the mode, set temperature, and fan speed.

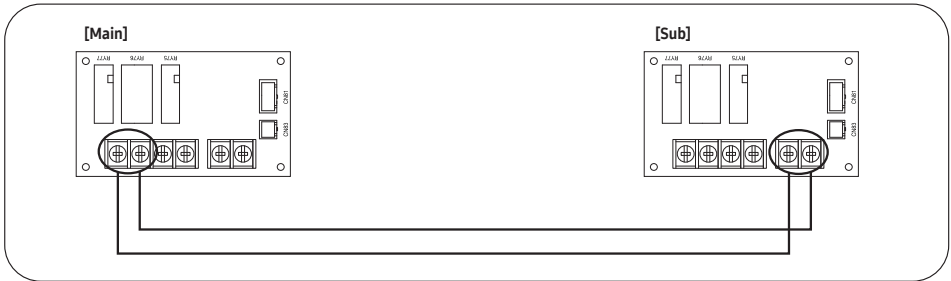

ETO operation specifications

See the details for SEG 14 and SEG 15 in the table titled '02 series installation option'.

1 Main indoor unit

- Based on the external contact control settings, the main indoor unit decides whether to generate output when an error (indoor unit stop) occurs.
- Based on the ETO settings, the main indoor unit decides whether to generate output according to the temperature and time conditions.

2 Sub indoor unit

- Based on the entrance control settings, the sub-indoor unit decides the mode, set temperature, and fan speed when contact inputs are given.

	Enable ETO	Enable external contact	Error port output
Main indoor unit	X	X	N/A
	X	O	Output due to an error
	O	X	Output by ETO entrance conditions (temperature / time / error occurrence)
	O	O	Output by ETO entrance conditions (temperature / time / error occurrence) * Ready to control the main contact input

	Enable entrance control	Enable external contact	Operation when outputting the Main
Sub indoor unit	X	X	N/A
	X	O	On with the previous operation conditions
	O	O	On with the entrance control enabled

Installation Procedure

Step 16 Setting the indoor unit option code with the wired remote control

To set the indoor unit option code use the wired remote control and follow the directions below.

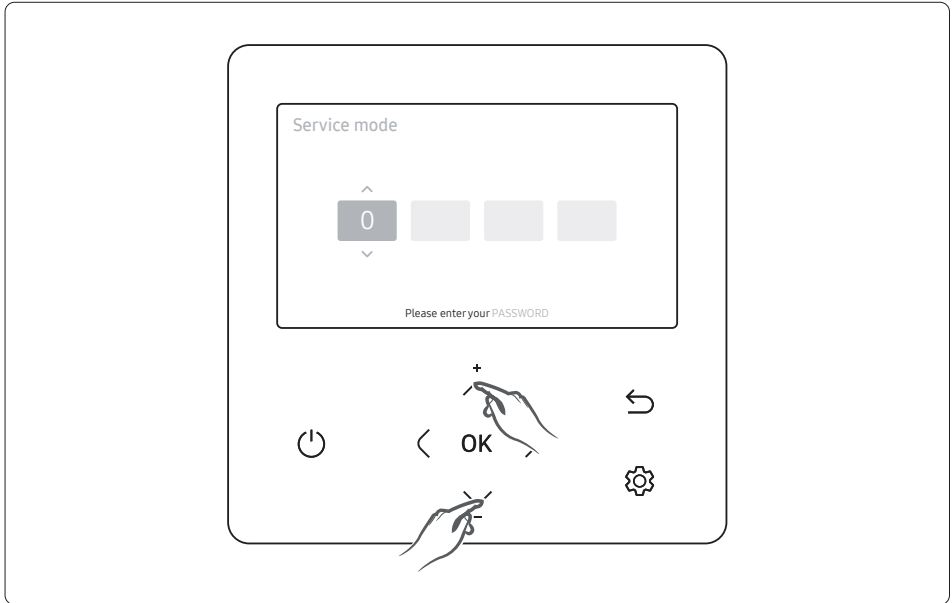

- 1 If you want to use the various additional functions for your Wired Remote Control, press the \wedge and \vee buttons at the same time for more than 3 seconds.
 - The password entry screen appears.
- 2 Enter the password, "0202," and then press the **OK** button.
 - The settings screen for installation/service mode appears.
- 3 See the list of additional functions for the Wired Remote Control on the next page, and then select the Product option menu.
 - Once you have entered the settings screen, the current setting appears.
 - Refer to the chart for data setting.
 - Using the \wedge / \vee buttons, change the settings and press the \rangle button to move to the next setting.
 - Press the **OK** button to save the new setting.
 - Press the \hookrightarrow button to move to the Home screen.

NOTE

- While setting the data, you can press the \hookrightarrow button to move to the Home screen after checking the saving status at a pop-up screen.

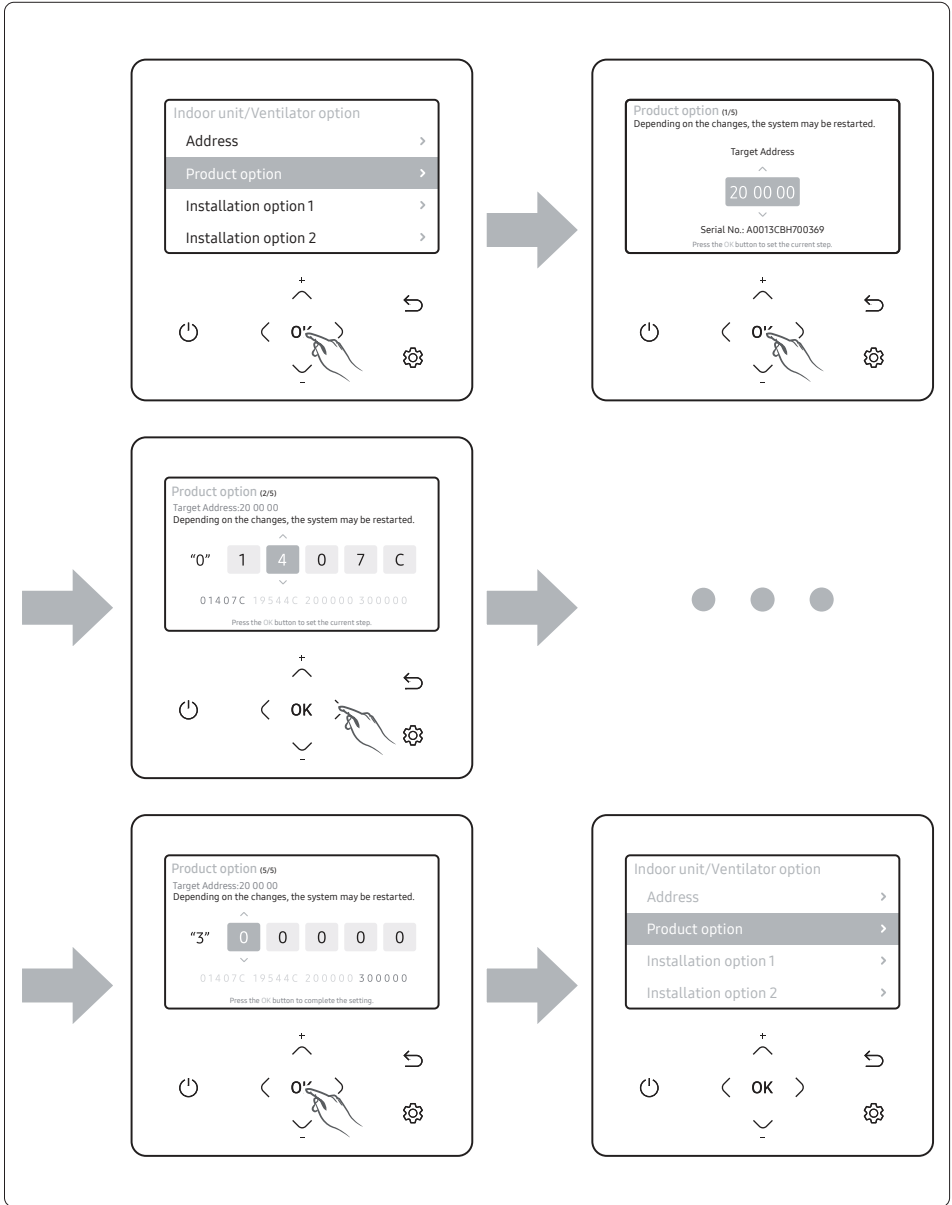

Installation Procedure

Product Option (1/5)

Depending on the changes, the system may be restarted.

Target Address

^

20 00 01

v

Serial No. : *****

Press the OK button to set the current step.

[Product Option 2page]

Product Option (2/5)

Target Address: 20 00 01

Depending on the changes, the system may be restarted.

"0" 1 **0** 0 0 0

00000 00000 00000 00000

Press the OK button to set the current step.

[Product Option 3page]

Product Option (3/5)

Target Address: 20 00 01

Depending on the changes, the system may be restarted.

"1" **0** 0 0 0 0

00000 00000 00000 00000

Press the OK button to set the current step.

[Product Option 4page]

Product Option (4/5)

Target Address: 20 00 01

Depending on the changes, the system may be restarted.

"2" **0** 0 0 0 0

00000 00000 00000 00000

Press the OK button to set the current step.

[Product Option 5page]

Product Option (5/5)

Target Address: 20 00 01

Depending on the changes, the system may be restarted.

"3" **0** 0 0 0 0

00000 00000 00000 00000

Press the OK button to set the current step.

SEG1	SEG2	SEG3	SEG4	SEG5	SEG6
0	*	*	*	*	*

Page number

SEG7	SEG8	SEG9	SEG10	SEG11	SEG12
1	*	*	*	*	*

Page number

SEG13	SEG14	SEG15	SEG16	SEG17	SEG18
2	*	*	*	*	*

Page number

SEG19	SEG20	SEG21	SEG22	SEG23	SEG24
3	*	*	*	*	*

Page number



CAUTION

- Option code will not be applied if you don't press the **OK** button.
- Setting the indoor unit option code is only possible in the Main wired remote Control. You can only check the indoor unit option code in Sub wired remote Control.
- Setting an indoor unit option code is possible when one indoor unit is connected. If more than 2 indoor units are connected, you can only check the Main indoor unit option code.

Installation Procedure

Step 17 Setting indoor unit addresses and installation options with wired remote control

Set the indoor unit address and installation option with the remote control option. Set each option separately since you cannot set the ADDRESS setting and indoor unit installation setting option at the same time. You need to set twice when setting the indoor unit address and installation option.

Setting an indoor unit address

- 1 If you want to use the various additional functions for your Wired Remote control, press the \wedge and \vee buttons at the same time for more than 3 seconds.
 - The password entry screen appears.
- 2 Enter the password, "0202," and then press the **OK** button.
 - The settings screen for installation/service mode appears.
- 3 See the list of additional functions for the Wired Remote control on the next page, and then select the Address menu.
 - Once you have entered the settings screen, the current setting appears.
 - Refer to the chart for data setting.
 - Using the \wedge / \vee buttons, change the settings and press the \rangle button to move to the next setting.
 - Press the **OK** button to save the new setting.
 - Press the \hookrightarrow button to move to the Home screen.

NOTE

- While setting the data, you can press the \hookrightarrow button to move to the Home screen after checking the saving status at a pop-up screen.

Indoor Unit/Ventilator Option

Address	>
Product Option	>
Installation Option 1	>
Installation Option 2	>







1	Address -Move to 'Address' page.
2	Product Option -Move to 'Product Option' page.
3	Installation Option 1 Move to 'Installation Option 1' page.
4	Installation Option 2 Move to 'Installation Option 2' page.

[Address > Main Address]	[Address > RMC Address]
<p>Main Address</p> <p>Target Address New address</p> <p>^</p> <p>20 00 01 0 8</p> <p>v</p> <p>Press the 'OK' button to complete the setting.</p>	<p>RMC Address</p> <p>Target Address New address</p> <p>^</p> <p>20 00 01 0 8</p> <p>v</p> <p>Press the 'OK' button to complete the setting.</p>
Address setting range : Main (0 ~ 4F) / RMC (0 ~ FE)	

NOTE

- Press the  button anytime during setup to exit without setting.
- Address will not be applied if you don't press **OK** button.
- Setting the Main/RMC Address of an Indoor unit is available only with a Main wired remote control.

Setting an indoor unit installation option

- 1 If you want to use the various additional functions for your Wired Remote control, press the  and  buttons at the same time for more than 3 seconds.
 - The password entry screen appears.
- 2 Enter the password, "0202," and then press the **OK** button.
 - The settings screen for installation/service mode appears.
- 3 See the list of additional functions for the Wired Remote control on the next page, and then select the Installation Option 1 menu.
 - Once you have entered the settings screen, the current setting appears.
 - Refer to the chart for data setting.
 - Using the  /  buttons, change the settings and press the  button to move to the next setting.
 - Press the **OK** button to save the new setting.
 - Press the  button to move to the Home screen.

NOTE

- While setting the data, you can press the  button to move to the Home screen after checking the saving status at a pop-up screen.

Installation Procedure

Installation Option 1 (1/5)

Depending on the changes, the system may be restarted.

Target Address



20 00 01



Serial No. : *****

Press the OK button to set the current step.

[Installation Option 1-2page]

Installation Option 1 (2/5)

Target Address: 20 00 01

Depending on the changes, the system may be restarted.

"0" 2 **0** 0 0 0

00000 00000 00000 00000

Press the OK button to set the current step.

[Installation Option 1-3page]

Installation Option 1 (3/5)

Target Address: 20 00 01

Depending on the changes, the system may be restarted.

"1" **0** 0 0 0 0

00000 00000 00000 00000

Press the OK button to set the current step.

[Installation Option 1-4page]

Installation Option 1 (4/5)

Target Address: 20 00 01

Depending on the changes, the system may be restarted.

"2" **0** 0 0 0 0

00000 00000 00000 00000

Press the OK button to set the current step.

[Installation Option 1-5page]

Installation Option 1 (5/5)

Target Address: 20 00 01

Depending on the changes, the system may be restarted.

"3" **0** 0 0 0 0

00000 00000 00000 00000

Press the OK button to set the current step.

SEG1	SEG2	SEG3	SEG4	SEG5	SEG6
0	2	RESERVED	External room temperature sensor / Minimizing fan operation when the thermostat is off	Central control	RESERVED
SEG7	SEG8	SEG9	SEG10	SEG11	SEG12
1	Drain pump & Emergency Stop	Hot Coil	Auxiliary heater	Controller variables for the auxiliary heater	RESERVED
SEG13	SEG14	SEG15	SEG16	SEG17	SEG18
2	External control	External control output	RESERVED	Buzzer	Maximum filter usage time
SEG19	SEG20	SEG21	SEG22	SEG23	SEG24
3	Individual control of a remote control	Heating setting compensation	RESERVED	Away Set OFF Timer	RESERVED

NOTE

- Press **S** button anytime during setup to exit without setting.
- Option code will not be applied if you don't press **OK** button.
- The setting Installation option code is available only with a Main wired remote control.
- Setting Installation option code is available when there is one-on-one connection between a wired remote control and an indoor unit.

Installation Procedure

Step 18 Optional : Setting the indoor unit addresses and the installation options with the wireless remote control

You cannot set both the indoor unit addresses and the installation options at the same time.
Receiver & display unit must be connected to the indoor unit to set options with the wireless remote control.

Common steps for setting the addresses and options

Remote controls

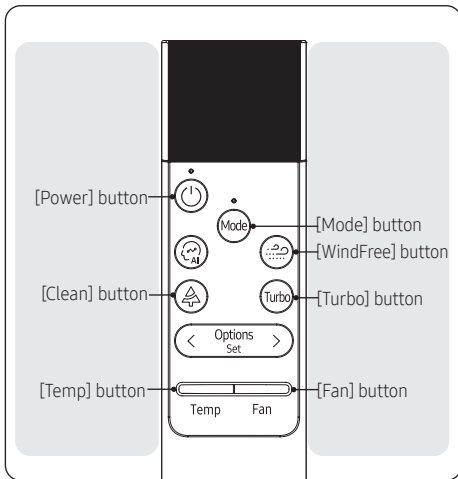

NOTE

- The remote control display and buttons may vary depending on the model.
- Enter the mode for setting the options.
 - Reset remote control : [Temp] button Down + [Fan] button Down + [Mode] Press for 10 seconds.
 - You can see the "SW Initialization" message and enter the following in 5 seconds.

- Press [WindFree] button and [Turbo] button for 5 seconds.
- Make sure that you are entered into the mode for setting options:

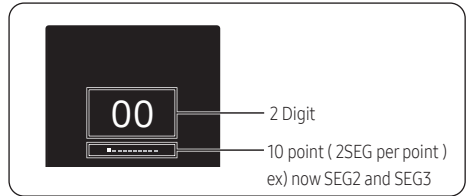

- Set the option values.

CAUTION

























- The total number of available options is 24 : SEG1 to SEG24.
- Because SEG1, SEG7, SEG13, and SEG19 are the page options used by the previous remote control models, the modes to set values for these options are skipped automatically.
- You can see 20 SEG (except SEG1, SEG7, SEG13, SEG19 SEG2 → ... → SEG6 → SEG8 → → SEG12 → SEG14 → → SEG18 → SEG20 → ... → SEG24

SEG1	SEG2	SEG3	SEG4	SEG5	SEG6
0	X	X	X	X	X
SEG7	SEG8	SEG9	SEG10	SEG11	SEG12
1	X	X	X	X	X
SEG13	SEG14	SEG15	SEG16	SEG17	SEG18
2	X	X	X	X	X
SEG19	SEG20	SEG21	SEG22	SEG23	SEG24
3	X	X	X	X	X

















- You can set the next SEG by pressing the mode button.
- You can change the digit value through the following operation.





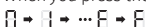











Left value : up or down, range : 0 ~ F
Right value : up or down, range : 0 ~ F

Take the steps presented in the following table:

























Steps	Remote control display
<p>1 Set the SEG2 and SEG3 values:</p> <p>a Set the SEG2 value by pressing the  button repeatedly until the value you want to set appears on the remote control display.</p> <p>b Set the SEG3 value by pressing the  button repeatedly until the value you want to set appears on the remote control display.</p> <p>When you press the  or  button, values appear in the following order:  →  → ... →  → </p>	 <p style="text-align: center;">SEG2</p>  <p style="text-align: center;">SEG3</p>
<p>2 Press the  button to move to the next page.</p>	
<p>3 Set the SEG4 and SEG5 values:</p> <p>a Set the SEG4 value by pressing the  button repeatedly until the value you want to set appears on the remote control display.</p> <p>b Set the SEG5 value by pressing the  button repeatedly until the value you want to set appears on the remote control display.</p> <p>When you press the  or  button, values appear in the following order:  →  → ... →  → </p>	 <p style="text-align: center;">SEG4</p>  <p style="text-align: center;">SEG5</p>
<p>4 Press the  button to move to the next page.</p>	























Installation Procedure

Steps	Remote control display
<p>5 Set the SEG6 and SEG8 values:</p> <p>a Set the SEG6 value by pressing the  button repeatedly until the value you want to set appears on the remote control display.</p> <p>b Set the SEG8 value by pressing the  button repeatedly until the value you want to set appears on the remote control display.</p> <p>When you press the  or  button, values appear in the following order: </p>	 <p>SEG6</p>  <p>SEG8</p>
<p>6 Press the  button to move to the next page.</p>	
<p>7 Set the SEG9 and SEG10 values:</p> <p>a Set the SEG9 value by pressing the  button repeatedly until the value you want to set appears on the remote control display.</p> <p>b Set the SEG10 value by pressing the  button repeatedly until the value you want to set appears on the remote control display.</p> <p>When you press the  or  button, values appear in the following order: </p>	 <p>SEG9</p>  <p>SEG10</p>
<p>8 Press the  button to move to the next page.</p>	

Steps	Remote control display
<p>9 Set the SEG11 and SEG12 values:</p> <p>a Set the SEG11 value by pressing the  button repeatedly until the value you want to set appears on the remote control display.</p> <p>b Set the SEG12 value by pressing the  button repeatedly until the value you want to set appears on the remote control display.</p> <p>When you press the  or  button, values appear in the following order: 0 → 8 → ... E → F</p>	 <p>SEG11</p>  <p>SEG12</p>
<p>10 Press the  button to move to the next page.</p>	
<p>11 Set the SEG14 and SEG15 values:</p> <p>a Set the SEG14 value by pressing the  button repeatedly until the value you want to set appears on the remote control display.</p> <p>b Set the SEG15 value by pressing the  button repeatedly until the value you want to set appears on the remote control display.</p> <p>When you press the  or  button, values appear in the following order: 0 → 8 → ... E → F</p>	 <p>SEG14</p>  <p>SEG15</p>
<p>12 Press the  button to move to the next page.</p>	

Installation Procedure

Steps	Remote control display
<p>13 Set the SEG16 and SEG17 values:</p> <p>a Set the SEG16 value by pressing the  button repeatedly until the value you want to set appears on the remote control display.</p> <p>b Set the SEG17 value by pressing the  button repeatedly until the value you want to set appears on the remote control display.</p> <p>When you press the  or  button, values appear in the following order:  →  → ... →  → </p>	 <p style="text-align: center;">SEG16</p>  <p style="text-align: center;">SEG17</p>
<p>14 Press the  button to move to the next page.</p>	
<p>15 Set the SEG18 and SEG20 values:</p> <p>a Set the SEG18 value by pressing the  button repeatedly until the value you want to set appears on the remote control display.</p> <p>b Set the SEG20 value by pressing the  button repeatedly until the value you want to set appears on the remote control display.</p> <p>When you press the  or  button, values appear in the following order:  →  → ... →  → </p>	 <p style="text-align: center;">SEG18</p>  <p style="text-align: center;">SEG20</p>
<p>16 Press the  button to move to the next page.</p>	

Steps	Remote control display
<p>17 Set the SEG21 and SEG22 values:</p> <p>a Set the SEG21 value by pressing the  button repeatedly until the value you want to set appears on the remote control display.</p> <p>b Set the SEG22 value by pressing the  button repeatedly until the value you want to set appears on the remote control display.</p> <p>When you press the  or  button, values appear in the following order:  →  → ... →  → </p>	 <p>SEG21</p>  <p>SEG22</p>
<p>18 Press the  button to move to the next page.</p>	
<p>19 Set the SEG23 and SEG24 values:</p> <p>a Set the SEG23 value by pressing the  button repeatedly until the value you want to set appears on the remote control display.</p> <p>b Set the SEG24 value by pressing the  button repeatedly until the value you want to set appears on the remote control display.</p> <p>When you press the  or  button, values appear in the following order:  →  → ... →  → </p>	 <p>SEG23</p>  <p>SEG24</p>

Installation Procedure

- 3 Check whether the option values you have set are correct by pressing the button repeatedly.

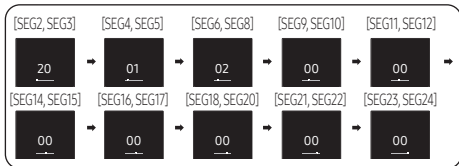

EX) AC***DNHDCG

020010-120000-200000-300000

- 4 Save the option values into the indoor unit:
Point the remote control to the remote control sensor on the indoor unit and then press the button on the remote control twice.
Make sure that this command is received by the indoor unit. When it is successfully received, you can hear a short sound from the indoor unit. If the command is not received, press the button again.
- 5 Check whether the air conditioner operates following the option values you have set:
- Reset the indoor or outdoor unit.
 - Indoor Unit : Press button + button for 5 seconds
 - Outdoor Unit: Press the K3 button

- b Reset remote control: button Down + button Down + Press for 10 seconds
You can see the "SW Initialization" message.

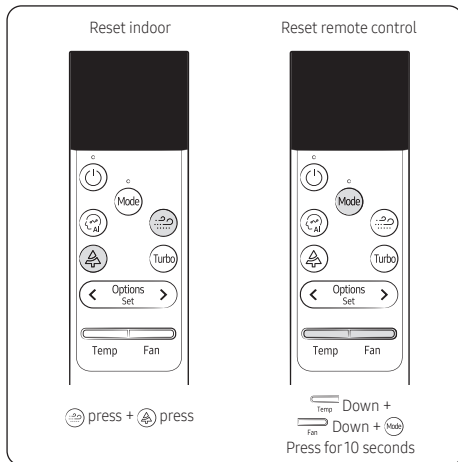

Setting the installation options in a batch

Installation option No. for an installation options :0XXXXX-1XXXXX-2XXXXX-3XXXXX

- 1 Make sure that the power is supplied to the indoor unit. If the indoor unit is not plugged in, it must include a power supply.



- 2 Set the installation options of indoor units, by referring to the following table and by following the steps in **Common steps for setting the addresses and options** on page 40.

- The installation options of indoor units are set to like a below table by default.

Model	AC***DN*DCG
Installation option 1	020010-100031-200000-300000
Installation option 2	050030-100700-200000-300000

- The SEG20 option, Individual control with remote control, allows you to control multiple indoor units individually by using the remote control.

02 series installation option (Detailed)

Option No. : 02XXXX-1XXXX-2XXXX-3XXXX

Option	SEG1		SEG2		SEG3	SEG4		
Explanation	PAGE		MODE			Use of external room temperature sensor / Minimizing fan operation when thermostat is off		
	Indication	Details	Indication	Details		Indication	Details	
Indication and Details	0		2	Installation Option 1	RESERVED		Use of external room temperature sensor	Minimizing fan operation when thermostat is off ¹⁾
						0	Disuse	Disuse
						1	Use	Disuse
						2	Disuse	Use(Heating)
						3	Use	Use(Heating)
						4	Disuse	Use(Cooling)
						5	Use	Use(Cooling)
						6	Disuse	Use (Cooling/Heating)
						7	Use	Use (Cooling/Heating)
						8	Disuse	Use (Cooling Ultra low speed)
						9	Use	Use (Cooling Ultra low speed)
						A	Disuse	Use (Heating/ Cooling Ultra low speed)
						B	Use	Use (Heating/ Cooling Ultra low speed)
Option	SEG5		SEG6		SEG7	SEG8		
Explanation	Use of central control				PAGE		Use of drain pump & Emergency Stop ²⁾	
	Indication	Details			Indication	Details	Indication	Details
Indication and Details	0	Disuse	RESERVED	1				0 or 4
					1 or 5	Use		
					2 or 6	Use with 3min delay		
					3 or 7	Disuse		
	1	Use			8 or C	Disuse	Use	
					9 or D	Use		
					A or E	Use with 3min delay		
					B or F	Disuse		

Installation Procedure

Installation Procedure

Option	SEG9		SEG10		SEG11			SEG12	
Explanation	Use of Hot Coil		Use of auxiliary heater		Controller variables for auxiliary heater			RESERVED	
Indication and Details	Indication	Details	Indication	Details	Indication	Details			
	0	Disuse	0	Disuse		Set temperature for auxiliary heat on	Time delay for auxiliary heat on		
					0	No temperature offset	No delay		
					1	No temperature offset	10 minutes		
					2	No temperature offset	20 minutes		
					3	2.7°F(1.5°C)	No delay		
					4	2.7°F(1.5°C)	10 minutes		
					5	2.7°F(1.5°C)	20 minutes		
					6	5.4°F(3°C)	No delay		
					7	5.4°F(3°C)	10 minutes		
	1	Use	1	Use	8	5.4°F(3°C)	20 minutes		
					9	8.1°F(4.5°C)	No delay		
					A	8.1°F(4.5°C)	10 minutes		
					B	8.1°F(4.5°C)	20 minutes		
					C	10.8°F(6°C)	No delay		
D					10.8°F(6°C)	10 minutes			
-	-	2	use, Heater time delay (Fan On When the heater is running)	E	10.8°F(6°C)	20 minutes			
Option	SEG13		SEG14		SEG15			SEG16	
Explanation	PAGE		Use of external control		Setting the output of external control			RESERVED	
Indication and Details	Indication	Details	Indication	Details	Indication	Details			
	2		0	Disuse	0	Thermo on			
			1	On/Off			1		Operation on
			2	Off					
			3	Window					
			4	Disuse	2	External heater use(Fan On when the heater is running) Emergency heater disuse			
			5	On/Off					
			6	Off					
			7	Window	3	External heater use(Fan OFF when the heater is running) Emergency heater disuse			
			8	Disuse					
			9	On/Off					
			A	Off	4	External heater use(Fan On when the heater is running, Fan off only in case of Defrost) Emergency heater disuse			
			B	Window					
			C	Disuse					
			D	On/Off	5	External heater use(Fan On when the heater is running) Emergency heater use			
E	Off								
F	Window								
		6	External heater use(Fan OFF when the heater is running) Emergency heater use						
		7	External heater use(Fan On when the heater is running, Fan off only in case of Defrost) Emergency heater use						

Option	SEG17		SEG18		SEG19		SEG20	
Explanation	Buzzer control		Maximum filter usage time ³⁾		PAGE		Individual control with remote control ⁴⁾	
Indication and Details	Indication	Details	Indication	Details	Indication	Details	Indication	Details
	0	Use of buzzer	2	1000 Hour	3		0 or 1	Indoor 1
	1	Disuse	6	2000 Hour			2	Indoor 2
							3	Indoor 3
4							Indoor 4	
Option	SEG21		SEG22		SEG23		SEG24	
Explanation	Heating setting compensation		RESERVED		Away Set OFF Timer		RESERVED	
Indication and Details	Indication	Details			Indication	Details		
	0	Disuse			0 or 1	Auto Set OFF 30Min.		
	1	3.6°F(2°C)			2	Auto Set OFF 60Min.		
	2	9°F(5°C)			3	Auto Set OFF 120Min.		
4			Auto Set OFF 180Min.					

- 1) SEG4

By SEG4 setting, minimize fan operation when the thermostat is off.

- Fan operates for 20 seconds at an interval of 5 minutes in heat mode.
- Fan stops or operates Ultra low in Cooling when the thermostat is off.

- 2) SEG8

Emergency Stop: If you set Emergency Stop to [Use], it is not possible to use the ETO or On/Off Control feature through External Control (SEG14).

- 3) SEG18

If you set the Maximum filter usage time option to a value other than 2 and 6, it is automatically set to 2 (1000 hours).

- 4) SEG20

If you set the Individual control with the remote control option to a value other than 0 to 4, it is automatically set to 0 (Indoor 1)

Installation Procedure

05 series installation option (Detailed)

Option No. : 05XXXX-1XXXXX-2XXXXX-3XXXXX

SEG1		SEG2		SEG3		SEG4			SEG5	SEG6	
Page		Mode		Reserved		Reserved			Reserved	Reserved	
Indication	Details	Indication	Details								
0		5	Installation Option 2								
SEG7		SEG8		SEG9		SEG10			SEG11	SEG12	
Page		Heater lock out		Heat pump lock out		Bit 0 : Allow Fan control in auto mode Bit 1 : Onboarding Type(AP / BLE) Bit 2 : MDS UX Type (Integration / separation)			0	Reserved	
Indication	Details	Indication	Details	Indication	Details	Indication	Details				
	0	Disuse		0	Disuse	0	Not allow	Ap Onboarding			Integration UX
1	1	65 °F(18.3 °C)	1	45 °F(7.2 °C)	1	allow	Ap Onboarding	Integration UX			
	2	60 °F(15.6 °C)	2	40 °F(4.4 °C)							
	3	55 °F(12.8 °C)	3	35 °F(1.7 °C)	2	Not allow	BLE Onboarding	Integration UX			
	4	50 °F(10.0 °C)	4	30 °F(-1.1 °C)							
	5	45 °F(7.2 °C)	5	25 °F(-3.9 °C)	3	allow	BLE Onboarding	Integration UX			
	6	40 °F(4.4 °C)	6	20 °F(-6.7 °C)							
	7	35 °F(1.7 °C)	7	15 °F(-9.4 °C)	4	Not allow	Ap Onboarding	Separation UX			
	8	30 °F(-1.1 °C)	8	10 °F(-12.2 °C)							
	9	25 °F(-3.9 °C)	9	5 °F(-15 °C)	5	allow	Ap Onboarding	Separation UX			
	A	20 °F(-6.7 °C)	A	0 °F(-17.8 °C)							
B	15 °F(-9.4 °C)	B	-5 °F(-20.6 °C)	6	Not allow	BLE Onboarding	Separation UX				
C	10 °F(-12.2 °C)	C	-10 °F(-23 °C)								
D	5 °F(-15 °C)	D	-15 °F(-26 °C)	7	allow	BLE Onboarding	Separation UX				
E	0 °F(-17.8 °C)	E	-20 °F(-29 °C)								
SEG13		SEG14		SEG15		SEG16			SEG17	SEG18	
Page		Reserved		Reserved		Reserved			Reserved	Reserved	
Indication	Details										
2											
SEG19		SEG20		SEG21		SEG22			SEG23	SEG24	
Page		Reserved		Reserved		Reserved			Reserved	Reserved	
Indication	Details										
3											

Installation Procedure

Changing the addresses and options individually

When you want to change the value of a specific option, refer to the following table and follow the steps in **Common steps for setting the addresses and options** on page 40.

Option	SEG1		SEG2		SEG3		SEG4		SEG5		SEG6	
Function	Page		Mode		Option mode to change		Tens position of the option number		Units position of the option number		New value	
Indication and details	Indication	Details	Indication	Details	Indication	Details	Indication	Details	Indication	Details	Indication	Details
		0		D		Option type	0 to F	Tens position value	0 to 9	Units position value	0 to 9	New value





Example: Changing the Buzzer control (SEG17) option of the installation options to 1 disuse.

Option	SEG1		SEG2		SEG3		SEG4		SEG5		SEG6	
Function	Page		Mode		Option mode to change		Tens position of the option number		Units position of the option number		New value	
Indication	0		D		2		1		7		1	

Installation Procedure

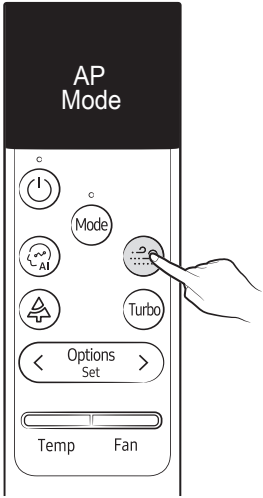
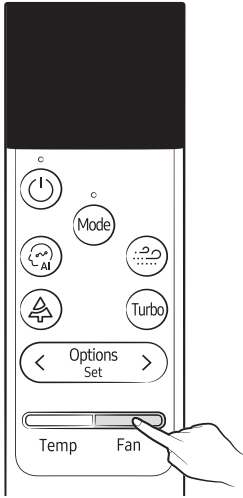
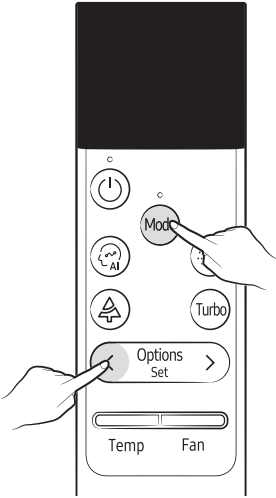
Step 19 Optional : LED Display indicator specifications when checking Wi-Fi Easy Setup and Wi-Fi status

The wireless remote control can be used for Easy Setup, checking the internet connection status and connecting or disconnecting Wi-Fi.

Easy Setup	Check internet connection status	Connect/Disconnect to Wi-Fi
		
<p>Press the  button for 5 seconds</p>	<p>Press the  button for 5 seconds</p>	<p>Press the  and  button for 5 seconds</p>

LED indicator Status

Duct		Indicators				Note	Action
		On / Off	Timer	Fan	Filter sign		
							
Easy Setup	AP Entry	●	●	●	●	All LEDs turn On	
	Device Check	◐	◐	◐	◐	All LEDs Flashing	
	Device Registration	◐	◐	◐	◐	LEDs Flashing sequentially (On/Off → Timer → Fan → Filter sign)	
	Connection success	◐	◐	◐	◐	All LEDs Flashing(During 3SEC)	
	Connection failed	X	X	X	X	All LEDs turn Off and operate in the original mode	AP setting, Wi-Fi module replacement
Check your internet connection	AP, when connected to the Internet normally	●	●	●	●	All LEDs turn On (During 5SEC)	Use normally
	When not connected to AP	X	X	X	X	All LEDs turn Off (During 5SEC)	AP setting, Wi-Fi module replacement
Wi-Fi function	When connected	◐	◐	◐	◐	All LEDs flash one time	-
	When disconnected	◐	◐	◐	◐		-
When setting AP with wired remote control		◐	◐	◐	◐	All LEDs Flashing (MAX10Min)	
Initialize connection information		◐	◐	◐	◐	LEDs Flashing sequentially (On/Off → Timer → Fan → Filter sign)	-
Initialize the device		◐	◐	◐	◐	LEDs Flashing sequentially (Filter sign → Fan → Timer → On/Off)	-

Installation Procedure

Step 20 Wi-Fi module Reinstallation guide

In some cases, the Wi-Fi module may need to be removed and relocated to improve the Wi-Fi signal connection.

AC***DNLDCG

1 Disassemble two screws and remove the Cover control.

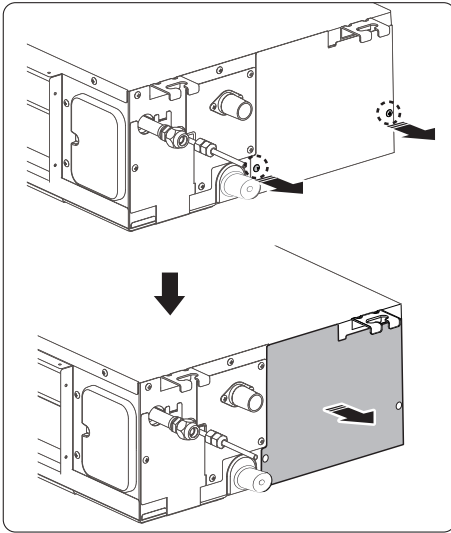

2 Disconnect Wi-Fi connector.

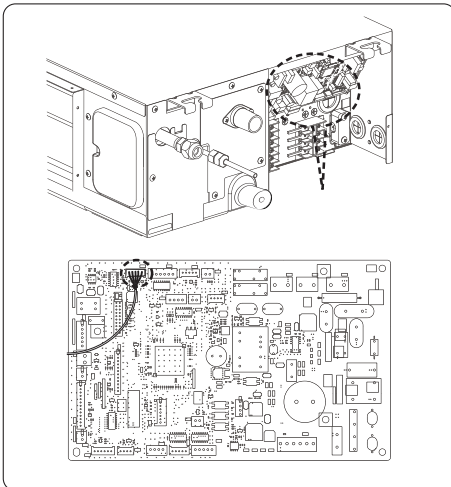

3 Remove one screw and remove the Cover case.

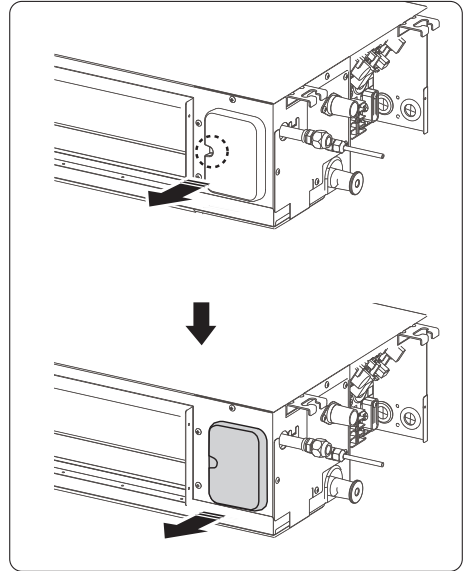

4 Pull the Wi-Fi wire through the wiring hole, and then take out the Wi-Fi module from the back side of the Cover pipe.

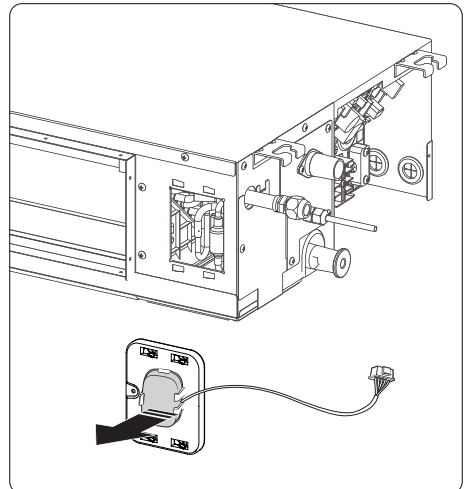

5 Connect the Wi-Fi wire connector through the wire hole.

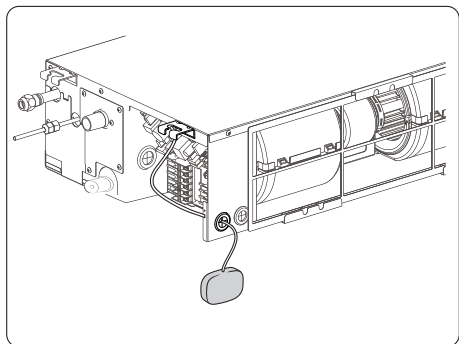

- If length extension is required, use an enclosed wire (Accessory bag).

6 Assemble the cover pipe and the Cover control.

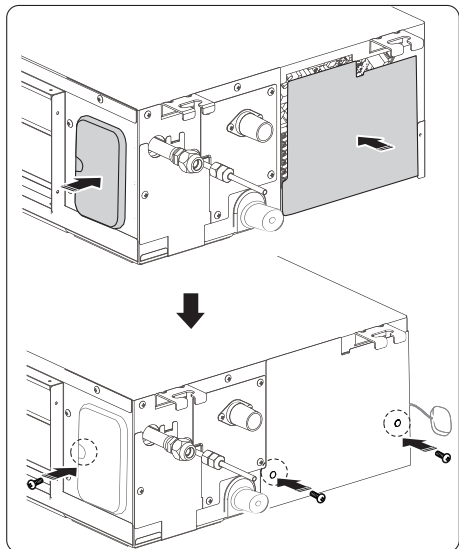

7 Fix the Wi-Fi module to the Ceiling to avoid the steel structure.

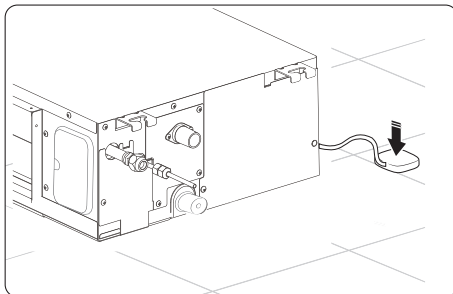

Installation Procedure

AC**DNHDCG

1 Disassemble two screws and remove the Cover control.

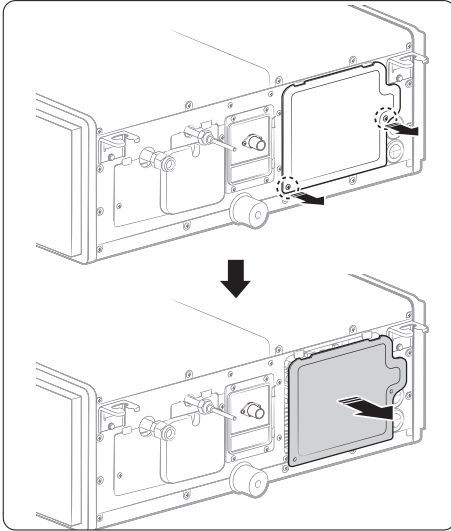

2 Disconnect the Wi-Fi connector.

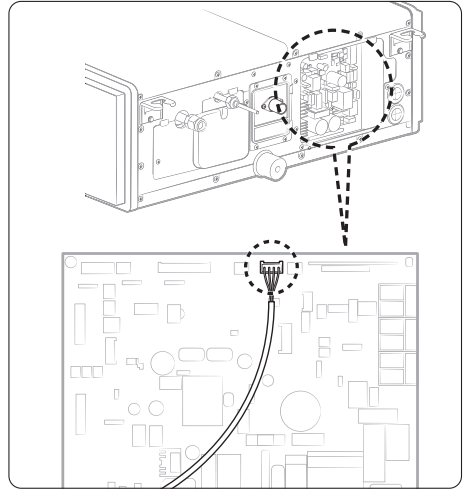

3 Disassemble two screws and remove the cover pipe.

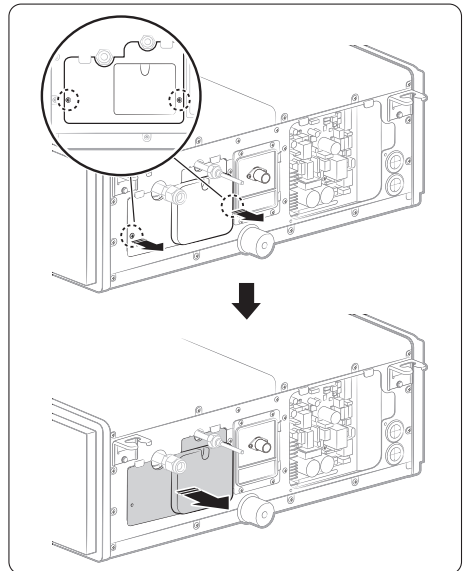

- 4 Pull out the Wi-Fi wire through the wire hole, and then take out the Wi-Fi module from the back side of the Cover pipe.

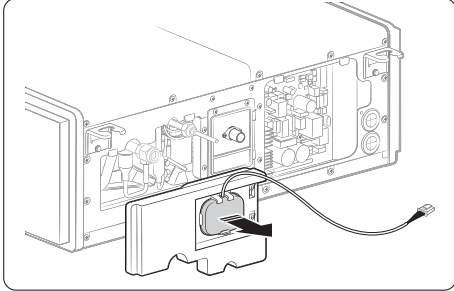

- 5 Connect the Wi-Fi wire connector through the wire hole.

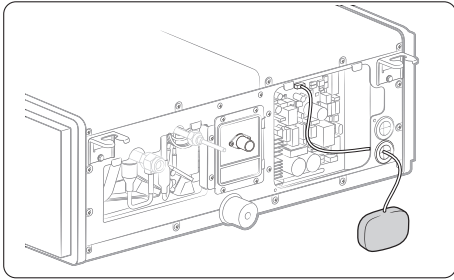

- If length extension is required, use an enclosed wire (Accessory bag).

- 6 Assemble the cover pipe and Cover control .

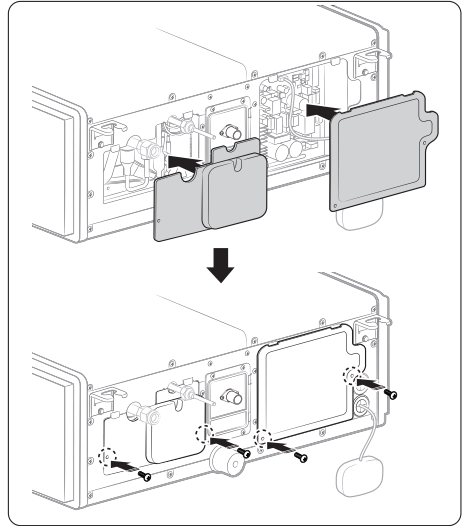



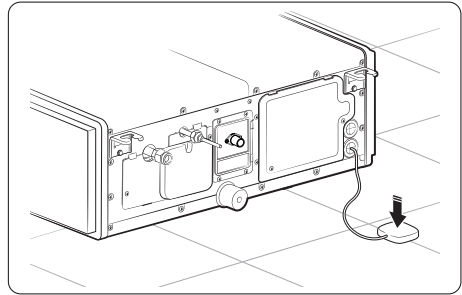





















- 7 Fix the Wi-Fi module to the Ceiling to avoid the steel structure.



Troubleshooting

- If an error occurs during the operation, one or more LEDs flicker and the operation is stopped except the LED.
- If you re-operate the air conditioner, it operates normally at first, then detects an error again.

Abnormal conditions	Indicators					Remarks
						
	Blue	Red				
Power reset		X	X	X	X	
Error of Room sensor in the indoor unit(Open/Short)	X	X		X	X	
Error of EVA-IN, EVA-OUT sensor in the indoor unit(Open/Short)		X		X	X	
Error of Fan motor in the indoor unit	X	X	X		X	
Error of Outdoor or Indoor fan PCB overheating error	X	X				
Clogging of outdoor's service valve		X	X			
1. Detection of the float switch 2. Emergency alarm system on(Emergency Stop)	X	X	X			
Error of EEPROM or OPTION SETTING						
1. No communication for 2 minutes between indoor units (Communication error for more than 2 minutes) 2. The Indoor unit receiving the communication error from the outdoor unit 3. Outdoor unit tracking 3 minutes error 4. When sending the communication error from the outdoor unit, the mismatching of the communication numbers and installed numbers after completion of tracking. (Communication error for more than 2 minutes)	X	X			X	1. Indoor unit error (Display is unrelated to operation) 2. Outdoor unit error (Display is unrelated to operation)

 On  Flickering X Off

- If you turn off the air conditioner when the LED is flickering, the LED is also turned off.

- If an error occurs,  is displayed on the wired remote control. If you would like to see an error code, press the Test button.

Display	Explanation	Remark
101	Communication Error between indoor and outdoor unit	
118	Indoor fan PCB overheating error	
121	Error of Room sensor in the indoor unit (Open/Short)	
122	Error of Eva In sensor in the indoor unit (Open/Short)	
123	Error of Eva Out sensor in the indoor unit (Open/Short)	
153	2nd Detection of the float switch	
154	Error of Fan motor in the indoor unit	
162	EEPROM error	
163	EEPROM option setting error	
202	No communication for 2 minutes between indoor units (Communication error for more than 2 minutes)	
422	Clogging of outdoor service valve	
557	Option code miss matching among the indoors (only for DPM)	Check the indoor option code
601	Error of communication between the indoor unit and wired remote control after 3 minutes.	Wired remote control error
604	Error of communication between the indoor unit and wired remote control after completion of 10 times tracking.	
606	COM1/COM2 Cross-installed error	
607	Error of Main wired remote control and Sub wired remote control setting	
665	Emergency alarm system on (Emergency Stop)	

SAMSUNG