

## OPERATION MANUAL

AIR CONDITIONER (Wall-Mounted type)

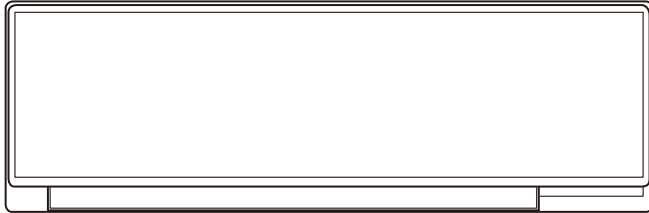

### MODEL: (KN series)

Write down the model name.  
(Refer to the rating label.)

Before using this product, read these instructions thoroughly and keep this manual for future reference.

[Original Instructions]

### Contents

1. SAFETY PRECAUTIONS.....	1
2. PREPARATION.....	2
2.1. Inserting batteries.....	2
3. NAME OF PARTS.....	3
3.1. Indoor unit.....	3
3.2. Remote controller.....	3
4. BASIC OPERATIONS.....	4
5. AIRFLOW SETTINGS.....	4
5.1. Fan speed setting.....	4
5.2. Airflow direction setting.....	4
6. TIMER OPERATIONS.....	5
6.1. On timer or Off timer.....	5
6.2. Program timer.....	5
6.3. Sleep timer.....	5
7. ENERGY SAVING OPERATION.....	5
7.1. Economy operation.....	5
7.2. Fan control for energy saving.....	5
8. OTHER OPERATION.....	6
8.1. Powerful operation.....	6
9. SETTINGS ON INSTALLATION.....	6
9.1. Remote controller custom code setting.....	6
10. CLEANING AND CARE.....	6
11. GENERAL INFORMATION.....	7
12. OPTIONAL PARTS.....	8
12.1. Wireless LAN control.....	8
13. TROUBLESHOOTING.....	10



PART No. 9387602593-01

## 1. SAFETY PRECAUTIONS

To prevent personal injury or property damage, read this section carefully before you use this product, and be sure to comply with the following safety precautions.

Incorrect operation due to failure to follow the instructions may cause harm or damage, the seriousness of which is classified as follows:



**WARNING**

This mark warns of death or serious injury.



**CAUTION**

This mark warns of injury or damage to property.



This mark denotes an action that is PROHIBITED.



This mark denotes an action that is COMPULSORY.

Explanation of symbols displayed on the indoor unit or outdoor unit.



Refrigerant Safety Group  
**A2L**

### WARNING

This symbol shows that this product uses a flammable refrigerant. If the refrigerant is leaked and exposed to an external ignition source, there is a risk of fire.



### CAUTION

This symbol shows that the operating manual should be read carefully.



### CAUTION

This symbol shows that a service personnel should be handling this equipment with reference to the installation manual.



### CAUTION

This symbol shows that information is available such as the operating manual or installation manual.



**WARNING**



- When installing this product to an unventilated area, pay attention to prevent fire and explosion caused by the stagnated gas in case of refrigerant leakage. (For products which contain more than 4.05 lbs (1.836 kg) refrigerant.)
- This product contains no user-serviceable parts. Always consult authorized service personnel for repairing, installation, and relocation of this product. Improper installation or handling will cause leakage, electric shock, or fire.
- If you notice anything unusual, such as a burning smell or water leak, stop operation of the air conditioner immediately and disconnect it from all power sources, either by turning off the circuit breaker or disconnecting the power plug. Afterwards, contact an authorized service personnel.
- Take care not to damage the power supply cable. If it is damaged, it should be replaced only by authorized service personnel in order to avoid a hazard.
- If a refrigerant leakage is suspected, all naked flames shall be removed or extinguished, and consult authorized service personnel.
- In the event of a thunder storm or any prior sign of a lightning strike, turn off the air conditioner via the remote controller, and refrain from touching the product or the power source to prevent any electrical hazards.
- This product shall be stored in a room without continuously operating ignition sources (for example: open flames, an operating gas appliance or an operating electric heater).

## WARNING

- This product shall be stored in a well-ventilated area.
  - Be aware that refrigerants may not contain an odour.
  - This product shall be stored so as to prevent mechanical damage from occurring.
  - Disposing of the product shall be done properly, in compliance with national or regional regulations.
  - During transportation or relocation of the indoor unit, pipes shall be covered with the wall hook bracket for protection. Do not move this product by holding the indoor unit pipes. (The stress applied to the pipe joints may cause the flammable gas to leak during operation).
  - This product is not intended for use by persons (including children) with reduced physical, sensory or mental capabilities, or lack of experience and knowledge, unless they have been given supervision or instruction concerning use of this product by a person responsible for their safety. Children should be supervised to ensure that they do not play with this product.
  - Dispose of the packing materials safely. Tear and dispose of the plastic packing bags so that children cannot play with them. There is danger of suffocation if children play with the original plastic bags.
- Do not install the unit in area filled with mineral oil such as a factory or area containing a large amount of splashed oil or steam such as a kitchen.
  - Do not install the unit in a location where it may be potentially exposed to leaked flammable gas or where corrosive gases are present, for example places near a hot spring.
  - Do not start or stop the operation of this product by inserting or pulling out the power plug, or by turning on or off the circuit breaker.
  - Do not use flammable gases near this product.
  - Do not expose yourself directly to the cooling airflow for many hours.
  - Do not insert your fingers or any other objects into the outlet port or intake grille.
  - Do not operate with wet hands.
  - Do not use means to accelerate the defrosting process or to clean this product, other than those instructed in this manual.
  - Do not pierce or burn.

## CAUTION

- Provide occasional ventilation during use.
  - Before cleaning this product, be sure to turn it off and disconnect all the power supply.
  - Always operate this product with air filters installed.
  - Ensure that any electronic equipment is at least 1 m (40 in) away from this product.
  - Disconnect all the power supply when not using this product for extended periods.
  - After a long period of use, ensure to get the mounting of the indoor unit checked to prevent this product from falling down.
  - The airflow direction and the room temperature should be carefully considered when you use this product in a room with infants, children, elderly or sick persons.
  - Keep the surroundings of the outdoor unit clean and tidy, and do not place items around it. Any objects blocking or entering from the outlet ports may cause product malfunction.
- Do not direct the airflow at fireplaces or heating apparatus.
  - Do not block or cover the intake grille and the outlet port.
  - Do not apply any heavy pressure to radiator fins.
  - Do not climb on, place objects on, or hang objects from this product.
  - Do not place any other electrical products or household belongings under this product. Dripping condensation from this product might get them wet, and may cause damage or malfunction of your property.
  - Do not expose this product directly to water.
  - Do not use this product for preservation of food, plants, animals, precision equipment, art work, or other objects. This may cause quality deterioration of those items.

## CAUTION

- Do not expose animals or plants to the direct airflow.
- Do not drink the drainage from the air conditioner.
- Do not pull the power supply cable.
- Do not touch the aluminum fins of heat exchanger built-in this product to avoid personal injury when you maintain the unit.
- Do not stand on unstable steps when operating or cleaning this product. It may overturn and can cause injury.

This product contains fluorinated greenhouse gases.

## 2. PREPARATION

### WARNING

- Take care to prevent infants and young children from accidentally swallowing the batteries.

### CAUTION

- If leaking battery fluid comes in contact with your skin, eyes, or mouth, immediately rinse with plenty of clean water, and consult your physician.
  - Exhausted batteries must be removed immediately, and be disposed according to the local laws and regulations of your region.
- Do not attempt to recharge dry batteries.
  - Do not use dry batteries that has been recharged.

#### Indoor unit accessories

Check that the following accessories are included.

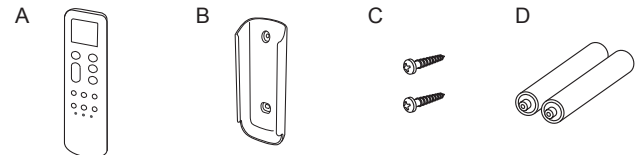

- A: Remote controller
- B: Remote controller holder
- C: Self-tapping screws
- D: Batteries

#### How to use the remote controller holder

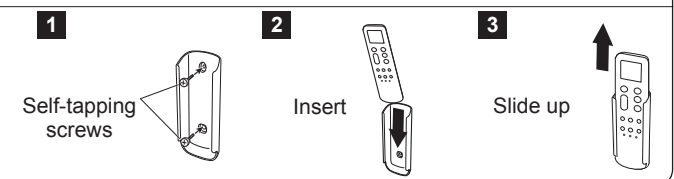

### 2.1. Inserting batteries

Battery type: R03/LR03/AAA × 2

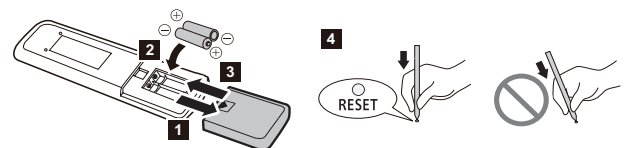

1~3. Put batteries as shown in the figure above.

4. Press  as shown in the figure above.

#### NOTES:

- Use specified type of batteries only.
- Do not mix different types or new and used batteries together.
- Batteries can be used about 1 year in ordinary use.
- If the remote control range noticeably shortens, replace the batteries, and press  as shown in the figure above.

### 3. NAME OF PARTS

#### CAUTION

- For appropriate signal transmission between the remote controller and the indoor unit, keep the signal receiver away from the following items:
  - Direct sunlight or other strong lights
  - Flat-panel television screen
- In rooms with instantaneous fluorescent lights, such as inverter type ones, the signal may not be transmitted properly. In such a case, consult the store of purchase.

#### 3.1. Indoor unit

##### NOTES:

- Model 09/12 is reference for the illustrations of indoor unit in this manual, unless otherwise noted.
- Operating procedures are applicable for all models.
- : The instruction is relating to the wireless LAN control (optional).

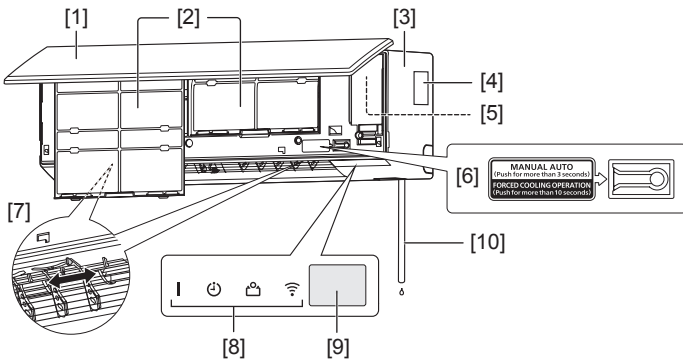

- [1] Intake grille  
Before starting operation, make sure that the intake grille is closed completely. Incomplete closing may affect the proper function or performance of the product.
- [2] Air filters
- [3] Front panel
- [4] Rating label
- [5] WLAN adapter slot (Under the wire cover)
- [6] For the Manual Auto operation and Filter indicator reset (Refer to page 11.)
- [7] Vertical louver
- [8] Indicator lamps
- [9] Remote control signal receiver
- [10] Drain hose

Indicator lamps light in the following conditions.

	Name	Color	Operation or condition
	Operation	Green	Normal operation
	Timer	Orange	Timer operation
	Economy	Green	Economy operation
	WLAN	Orange	Wireless LAN control is active.

#### 3.2. Remote controller

#### CAUTION

- To prevent malfunction or damage of the remote controller:
  - Place remote controller at where will not be exposed to direct sunlight or excessive heat.
  - Remove batteries if the product is not going to be used for an extended period.
- Obstacles such as a curtain or wall between the remote controller and the indoor unit may affect the appropriate signal transmission.
- Remove the protective film before use.

#### CAUTION

- Keep the remote control out of reach of infants and young children.
- Keep the batteries out of reach of infants and young children.
- Do not apply strong shocks to the remote controller.
- Do not pour water on the remote controller.

When you use the optional remote controller, the appearance and the operation procedure may differ.  
For details, refer to the operation manual of each remote controller.

- : The setting must be done while the setting screen is displayed for each function.
- : The button is controllable only when the air conditioner is operating.
- : The instruction is relating to the wireless LAN control (optional).

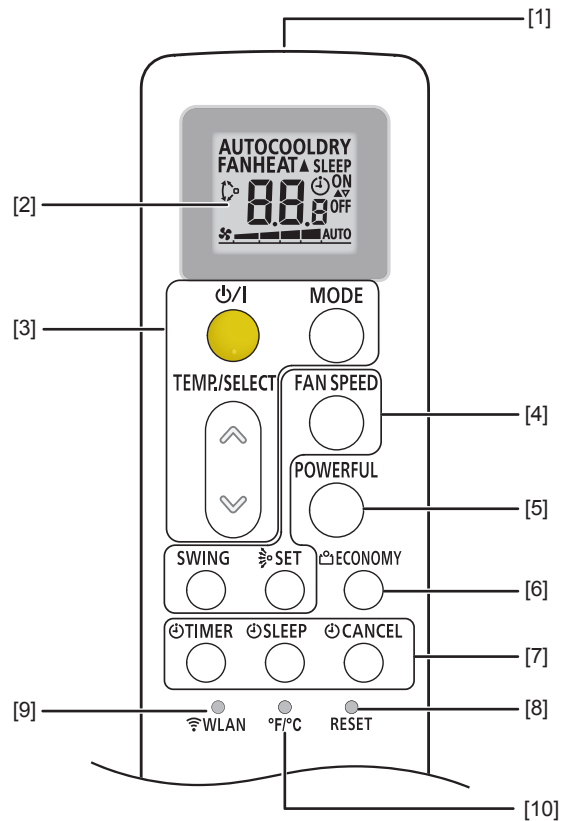

#### [1] Signal transmitter

- Aim at the signal receiver of the indoor unit properly.
  - Operating range is approximately 22 ft (7 m).
  - [▲] will appear when the signal is transmitted.
  - The indoor unit will emit a beep when it receive the signal properly. If there is no beep, press the button again.

#### [2] Remote controller display

In this section, all the possible indicators are displayed for description. In actual operation, the display is linked with the button operation, and only shows the necessary indicators for each setting.

#### [3] For Basic operations ..... Refer to page 4.

	Starts or stops the air conditioner operation.	
	Changes the operation mode.	*
	Adjusts the setting temperature./ Adjusts the value of the timer settings.	*

**[4] For Airflow settings ..... Refer to page 4.**

FAN SPEED 	Controls the fan speed.	*
SWING 	Starts or stops the automatic Swing operation.	
SET 	Controls the up/down airflow direction.	

**[5] For Powerful operation ..... Refer to page 6.**

POWERFUL 	Activates or deactivates the Powerful operation.	
--------------	--	--

**[6] For Energy saving operation .. Refer to page 5.**

ECONOMY 	Activates or deactivates the Economy operation.	
-------------	---	--

**[7] For Timer operations ..... Refer to page 5.**

TIMER 	Starts the timer setting.	*
SLEEP 	Activates the Sleep timer.	*
CANCEL 	Deactivates the timer setting.	

**[8] After replacing batteries..... Refer to page 2.**

RESET 	Resets the settings of the remote controller.	
-----------	---	--

**[9] For wireless LAN control ..... Refer to page 8.**

WLAN 	Starts the wireless LAN setting.	
----------	----------------------------------	--

**[10] For temperature unit switching ....Refer to page 4.**

F/C 	Switches the temperature unit on the remote controller display (°F ⇄ °C).	
---------	---	--

**How to press the button inside the hole**

Press this button as shown in the following figure. Use the tip of a ballpoint pen or other small object.



## 4. BASIC OPERATIONS

### 3 steps to start operation

- Press to start or stop the operation.
- Press MODE to select the operation mode.  
The operation mode changes as follows.  

AUTO (Auto)	→	COOL (Cool)	→	DRY (Dry)	→	FAN (Fan)	→	HEAT (Heat)
-------------	---	-------------	---	-----------	---	-----------	---	-------------
- Press TEMR/SELECT () to set the desired temperature.  
The temperature changes by 1 °F (0.5 °C) increments.

Temperature setting range	
Auto/Cooling/Dry	64-88 °F (18.0-30.0 °C)
Heating	60-88 °F (16.0-30.0 °C)

### NOTES:

- In the Cooling or Dry mode, set the temperature lower than the current room temperature.
- In the Heating mode,
  - set the temperature higher than the current room temperature.
  - at the beginning of the operation, the indoor unit fan rotates at very low speed for 3-5 minutes.
  - the Automatic defrosting operation overrides the Heating operation when necessary.
- In the Fan mode, temperature control is not available.

### Temperature unit switching

(Factory setting: °F)

Each time you press °F/°C, the temperature unit switches (°F ⇄ °C).



## 5. AIRFLOW SETTINGS

### 5.1. Fan speed setting

Press FAN SPEED to control the fan speed.

The fan speed changes as follows.

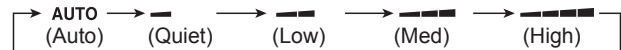

When **AUTO** is selected, the fan speed depends on the operating condition.

### NOTE:

- In the Dry mode, the fan speed is fixed to **AUTO**.

### 5.2. Airflow direction setting

For details of the airflow ranges, refer to "Airflow direction range".

#### Up/down airflow direction setting

Press SET to adjust the up/down airflow direction.

#### Left/right airflow direction setting

### CAUTION

Before you adjust the left/right airflow direction, make sure that the horizontal louver has been stopped completely.

Adjust two knobs by hand.

#### Swing operation setting

Press SWING to start/stop the Swing operation.

### NOTE:

- The Swing operation may stop temporarily when the indoor unit fan is rotating at very low speed or is stopped.

#### Airflow direction range

Up/down airflow direction

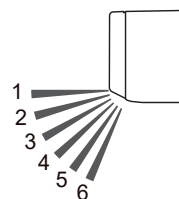

Change by SET	1 ⇄ 2 ⇄ 3 ⇄ 4 ⇄ 5 ⇄ 6
<b>Swing operation by SWING</b>	
Cooling, Dry	1 ⇄ 4
Heating	3 ⇄ 6
Fan (*1)	1 ⇄ 4 or 3 ⇄ 6

\*1: The Swing operation range depends on the airflow direction set before the Swing operation.

**NOTES:**

- Do not adjust the horizontal louvers by hand.
- In the Auto or Heating mode, the airflow direction stay position 1 for a while from the start of the operation.
- In the Cooling or Dry mode, the downward airflow can change to the upper as follows. This feature is to prevent condensation from dripping and damaging your property.  
Condition: Position 4-6 keeps for 30 minutes  
Airflow adjusted to: Position 3
- When using the mobile app (optional WLAN adapter is necessary), the up/down airflow can be selected from 4 positions.

## 6. TIMER OPERATIONS

**NOTE:** When [ ] indicator on the indoor unit blinks, set the clock and timer again. This blinking shows that the internal clock go wrong due to an interruption of the power supply.

### Timer setting procedure

1. Press [ ] to choose timer operation.

Each time you press the button, the timer operation will change as follows:

	Off timer	Stops the operation at your desired time.
	On timer	Starts the operation at your desired time.
	Program timer	Operates as the combination of the On timer and Off timer.

- To cancel the timer setting during the procedure, press [ ] .
  - To set sleep timer, press [ ] SLEEP. (Refer to “6.3. Sleep timer”.)
2. Set each timer operation.  
For details, refer to the following instructions of each timer setting.

### 6.1. On timer or Off timer

- Select On timer or Off timer in step 1 of “Timer setting procedure”.
- Each time you press TEMP/SELECT ( ), the time changes as follows:

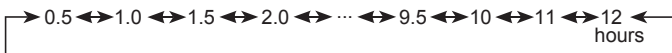

- When you use the On timer, set the time while the ON indicator on the remote controller display is blinking.
- When you use the Off timer, set the time while the OFF indicator on the remote controller display is blinking.
- To deactivate the On/Off timer, press [ ] CANCEL while [ ] or [ ] is shown on the remote controller display. The indicator will disappear.

**NOTE:**

- If you set the Sleep timer after setting the On/Off timer, the On/Off timer is canceled.

### 6.2. Program timer

- Set On timer and Off timer. (Refer to “6.1. On timer or Off timer”.)
- Select Program timer in step 1 of “Timer setting procedure”.

After the time set by the earlier timer passed, the timer set later will begin the counting down.  
The order of the timer operation is displayed as follows:

Timer	Indicator on the remote controller display
Off→On timer	
On→Off timer	

**NOTE:**

- If you set the Sleep timer after setting the Program timer, the Program timer is canceled.

### 6.3. Sleep timer

The Sleep timer supports your comfortable sleep by moderating the air conditioner operation gradually.

Press [ ] SLEEP.

Each time you press the button, the time changes as follows:



To repeat the timer, press the button when [ ] indicator is not displayed.

During the Sleep timer operation, the setting temperature changes as the following figure.

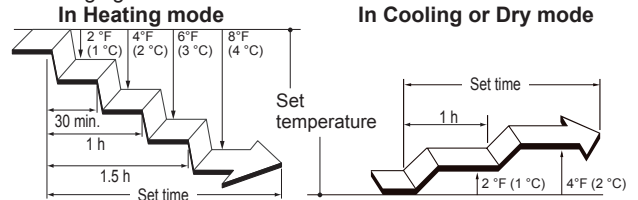

After the set time has elapsed, the air conditioner operation turns off.

## 7. ENERGY SAVING OPERATION

### 7.1. Economy operation

It saves more electricity than other operation modes by changing the set temperature to a moderate setting.

Press [ ] ECONOMY to activate/deactivate the Economy operation.

[ ] indicator on the indoor unit will turn on.

Operation mode	Room temperature
Cooling/Dry	Few degrees higher than the set temperature
Heating	Few degrees lower than the set temperature

**NOTES:**

- In the Cooling, Heating, or Dry mode, the maximum output of this operation is approximately 70 % of usual operation.
- This operation cannot be performed during the temperature monitoring by the Auto mode.

### 7.2. Fan control for energy saving

In the Cooling operation, when the room temperature reaches the set temperature, the indoor unit fan rotates intermittently to save power. (This function is deactivated at the time of purchase.)



To change the setting, use the following steps;

- Press [ ] until only the clock is displayed.
- Press and hold FAN SPEED for more than 5 seconds. The FC and the current status will appear.  
ON : Activated  
OFF : Deactivated
- Press TEMP/SELECT ( ) to switch the status.
- Press [ ] to send the setting to the indoor unit. The display will return to the original screen.

**NOTE:**

- If you do not press any buttons for 30 seconds after FC is displayed, FC will turn off. In this case, repeat the setting from step 2.

## 8. OTHER OPERATION

### 8.1. Powerful operation

In the Powerful operation, the air conditioner will operate at maximum power and strong airflow to cool down or warm up the room quickly.

☞ Press **POWERFUL** to activate/deactivate the Powerful operation.

When activated, the indoor unit will emit 2 short beeps.

When deactivated, the indoor unit will emit 1 short beep.

The Powerful operation will be turned off automatically in the following situations:

- The Powerful operation runs for a certain amount of time and the room temperature reaches the set temperature in the Cooling, Dry, or Heating mode.
- 20 minutes after the Powerful operation has started.

#### NOTES:

- The airflow direction and the fan speed are controlled automatically.
- The Powerful operation cannot be performed simultaneously with Economy operation.

## 9. SETTINGS ON INSTALLATION

### 9.1. Remote controller custom code setting

By setting custom code of indoor unit and remote controller, you can specify the air conditioner which the remote controller controls.

When two or more air conditioners are in the room and you wish to operate them separately, set the custom code (4 selections possible).

**NOTE:** If custom codes is different between the indoor unit and the remote controller, the indoor unit cannot receive a signal from the remote controller.

#### How to set the remote controller custom code

1. Press **⏻/I** until only the clock is displayed.
2. Press and hold **MODE** for more than 5 seconds.  
The current custom code will be displayed (initially set to A).
3. Press **TEMP/SELECT** ( $\curvearrowright$   $\curvearrowleft$ ) to change the custom code between A (A)  $\leftrightarrow$  B (b)  $\leftrightarrow$  C (c/t)  $\leftrightarrow$  D (d).

#### NOTE:

- Match the custom code on the display to the air conditioner custom code.

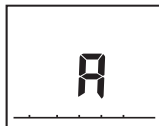

4. Press **MODE** again.  
The custom code will be set.  
The display will return to the original display.

- To change the air conditioner custom code, contact authorized service personnel (initially set to A).
- If you do not press any buttons for 30 seconds after the custom code is displayed, the displayed custom code is set and the display returns to the original display.
- Depending on the remote controller, the custom code may return to A when replacing the batteries. In this case, reset the custom code as necessary. If you do not know the air conditioner custom code, try each code until you find the code which operates the air conditioner.

## 10. CLEANING AND CARE

### ⚠ CAUTION

- ❗ Before cleaning this product, be sure to turn it off and disconnect all the power supply.
- Before starting operation, make sure that the intake grille has been shut completely. Incomplete closing of the intake grille might have an effect on the proper working or performance of the air conditioner.
- If the filter cleaning involves high-place work, consult the authorized service personnel.

- ⊘ Do not touch the aluminum fins of heat exchanger built-in the indoor unit to avoid personal injury when you maintain the unit.
- Do not expose the indoor unit to liquid insecticides or hair sprays.
- Do not stand on slippery, uneven or unstable surfaces when you maintain the unit.

#### NOTES:

- Model 09/12 is reference for the illustrations of indoor unit in this manual, unless otherwise noted.
- Operating procedures are applicable for all models.

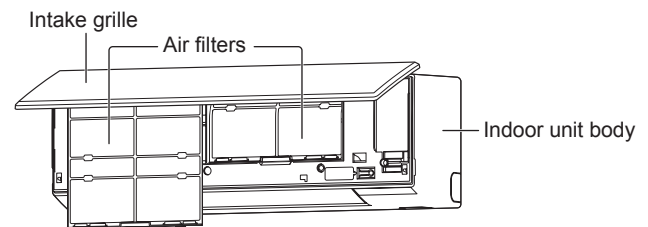

### ■ Frequencies at which the components are to be maintained

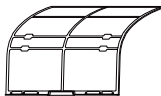
Name of parts	Frequency	
	Cleaning	Replacing
Indoor unit body, intake grille	When you notice	—
Air filter 	Every 2 weeks	—

### Cleaning indoor unit body

#### NOTES:

- Do not use water hotter than 104 °F (40 °C).
  - Do not use scouring cleanser, volatile solvents such as benzene or thinner.
1. Wipe the indoor unit body gently with a soft cloth moisten with warm water.
  2. Wipe the indoor unit body gently with a dry and soft cloth.

## Cleaning air filter

1. Open the intake grille.

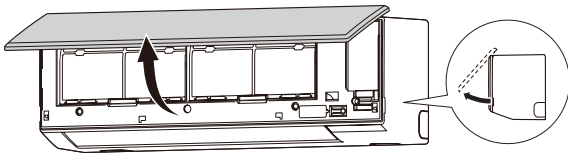

2. Remove the air filters.

Pull up the air filter knob, remove the two tabs at the bottom, and take it out of the indoor unit.

Air filter knob

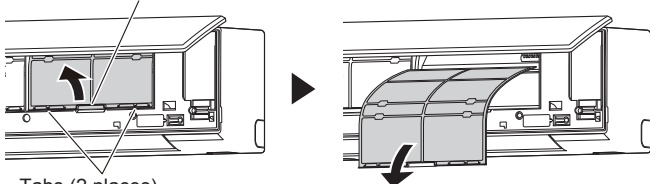

Tabs (2 places)

3. Remove the dust in either of the following ways.

- Clean the air filters with a vacuum cleaner.
- Wash the air filters with mild detergent and warm water. After washing, dry them thoroughly in shade.

4. Reattach the air filters.

Insert the air filter so that the left and right sides follow the guide grooves on the unit. Ensure you securely insert the two tabs at the bottom into the fixing holes.

5. Close the intake grille.

Press 4 places on the intake grille to close it completely.



### NOTE:

- Accumulated dust on the air filter reduces the air conditioner's operation efficiency, which may result in lower airflow and louder operation noise.

## Removing and installing intake grille

### ■ Removing intake grille

1. Open the intake grille.
2. Removing intake grille

[AS\*\*09/12KN\*\*]

While pressing the left and right mounting shafts outward gently, pull the intake grille.

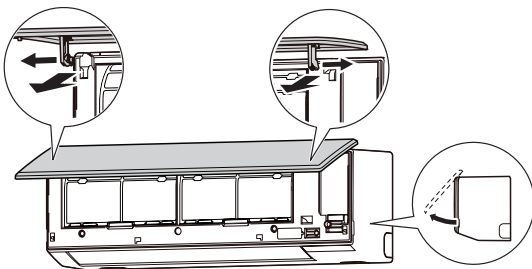

[AS\*\*18KN\*\*]

Pull the mounting shafts while keeping the intake grille in a horizontal position.

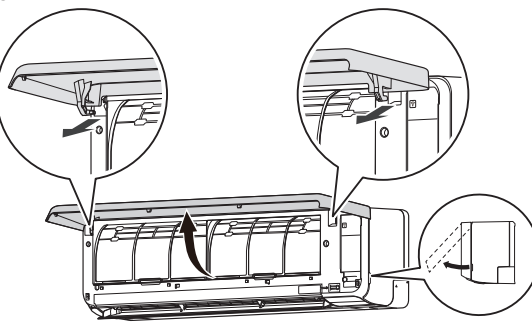

### ■ Installing intake grille

1. While holding the intake grille horizontal, set the left and right mounting shafts into the pillow blocks at the top of the front panel. Insert the shaft until it snaps to latch each shaft properly.
2. Close the intake grille. Press 4 places on the intake grille to close it completely.



## When not using for an extended period

When suspending use of the air conditioner after using the Cooling or Dry mode, perform Fan mode for half a day to dry the internal parts thoroughly. Moisture left inside the indoor unit may cause mold.

## Additional inspection

After a long period of use, dust may accumulate inside the indoor unit even when it has been periodically cleaned, deteriorating performance and also potentially causing health problems.

In such a case, a product inspection is recommended.

For more information, consult authorized service personnel.

## Filter indicator reset (Special setting)

This function can be used if set correctly during installation. Consult authorized service personnel in order to use this function.

- ☞ Clean the air filter when the indicator lamp shows the following:

Indicator lamp	Blinking pattern
	Blinks 3 times, at intervals of 21 seconds

After cleaning, reset the filter indicator by pushing on the indoor unit for 2 seconds or less. (Refer to page 3.)

# 11. GENERAL INFORMATION

### ■ Heating performance

This air conditioner operates on the heat-pump principle, absorbing heat from air outdoors and transferring that heat to the indoor unit. As a result, the operating performance is reduced as outdoor air temperature drops.

If you feel that the heating performance is insufficient, we recommend you to use this air conditioner in conjunction with other kinds of heating appliance.

### ■ Automatic defrosting operation

When outdoor temperature is very low with high humidity, frost may form on the outdoor unit during the heating operation, and it could reduce the operating performance of the product.

For frost protection, an automatic defrost function is equipped in this air conditioner.

If frost forms, the air conditioner will temporarily stop, and defrost circuit will operate briefly (maximum of 15 minutes.)

[ ] indicator on the indoor unit blinks during this operation.

If frost forms on the outdoor unit after the Heating operation, the outdoor unit will stop automatically after it operates for a few minutes. Then the Automatic defrosting operation starts.

### ■ Auto restart function

In event of power interruption such as a blackout, the air conditioner stops once. But it restarts automatically and performs previous operation when the power supply is resumed.

If any power interruption occurs after the timer is set, counting down of the timer will be reset.

After the power supply is resumed, [ ] indicator on the indoor unit blinks to notify you that there has been a timer fault. In such a case, reset the clock and timer settings.

## Malfunctions caused by other electrical devices

Use of other electrical appliances such as an electric shaver or nearby use of a wireless radio transmitter may cause the malfunction of the air conditioner.

If you encounter such a malfunction, turn off the circuit breaker once. Then turn it on again, and resume operation by using the remote controller.

## Operable conditions of temperature and humidity

Permissible ranges of temperature and humidity are as follows:

Indoor temperature	Cooling/Dry	[°F (°C)]	64 to 90 (18 to 32)
	Heating	[°F (°C)]	60 to 86 (16 to 30)
Outdoor temperature	Cooling/Dry	[°F (°C)]	50 to 126 (10 to 52) (*1)
			50 to 122 (10 to 50) (*2)
	Heating	[°F (°C)]	5 to 75 (-15 to 24) (*1)(*2)
Indoor humidity		[%]	80 or less (*3)

\*1: Suction temperature of the outdoor unit. (ASLH\*\*KN\*\*)

\*2: Suction temperature of the outdoor unit. (ASUH\*\*KN\*\*)

\*3: If the air conditioner is used continuously for many hours, water may condense on the surface and drip.

- If the unit is operated under the conditions except the permissible temperature range, the air conditioner operation may stop because of the automatic protection circuit working.
- Depending on the operating conditions, the heat exchanger may freeze, causing water leakage or other malfunction (in the Cooling or Dry mode).

## Other information

- Do not use the air conditioner for any purpose other than room cooling/dry, room heating or fan.

# 12. OPTIONAL PARTS

## 12.1. Wireless LAN control

To use the wireless LAN control, the WLAN adapter and mobile app is necessary.

Consult authorized service personnel in order to install the WLAN adapter.

For how to operate the mobile app, refer to the operation manual of the mobile app.

After installation by authorized service personnel, retrieve the adapter information label and stick it in this manual.

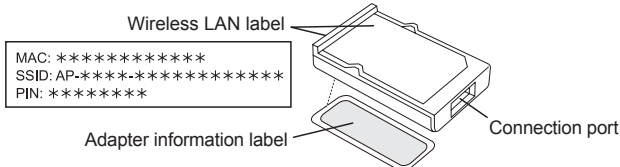

### Information on WLAN adapter

Paste Adapter information label here

Wireless LAN-compatible standard	IEEE 802.11 b/g/n
Frequency bands	2.4 GHz (in the U.S. or Canada: 1 ch to 11 ch) (in the other regions: 1 ch to 13 ch)
Maximum radio-frequency power	40 mW
Wireless LAN security	Open WEP WPA (PSK) WPA2_Personal (PSK) WPS for same-LAN Registration

“AIRSTAGE Mobile” is a trademark of FUJITSU GENERAL LIMITED.

Android and Google Play are registered trademarks of Google LLC.

App Store is a service mark of Apple Inc., registered in the U.S. and other countries.

iOS is a trademark or registered trademark of Cisco in the U.S. and other countries and is used under license.

## Setting to use wireless LAN control

### Step 1. Application software installation

1. Open “Google Play” or “App Store” depending on the type of your smartphone or tablet PC.
2. Search for “AIRSTAGE Mobile”.
3. Install the application software (mobile app) following the instructions on your screen.

#### NOTE:

- If you cannot find the application software (mobile app), it is currently not available in your region.

### Step 2. User registration

1. Open the installed mobile app.
2. Register the user (with either a smartphone or tablet PC) by following the instructions in the create an account section of the mobile app.

### Step 3. Air conditioner registration (pairing of WLAN adapter)

#### NOTES:

- Before starting this setting, reconnect the power supply of the air conditioner and wait for 60 seconds or more.
- Check that the smartphone or tablet PC is linked to the access point you are connecting the air conditioner. The setting will not work if it is not connected to the same access point.
- To control 2 or more air conditioners with the same smartphone or tablet PC, repeat the setup of the chosen mode.

☞ Register the air conditioner by following the instructions on the mobile app.

This operation manual describes only the setting procedure of the remote controller.

### For reference



When the registration is completed, [  ] indicator on the indoor unit will turn on.

#### <Manual connection>

Setting procedure of the remote controller

##### NOTE:

- If you do not press any buttons of the remote controller for 60 seconds, the remote controller display will return to the original display.

1. Press  2 times as shown in page 4.  
 will be displayed on the remote controller display.

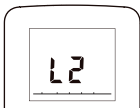

2. Press .

3. Make sure that "01" is shown on the remote controller display.

If "02" is shown, press TEMP/SELECT () to select "01".

4. Press .

The indoor unit enters the Manual connection mode and [  ] indicator on the indoor unit will blink.

##### NOTE:

- If the registration is not be finished in several minutes, Manual mode is canceled and [  ] indicator turns off. In this case, repeat the remote controller setting.





### For reference

#### <Easy connection>

Setting procedure of the remote controller

##### NOTE:

- If you do not press any buttons of the remote controller for 60 seconds, the remote controller display will return to the original display.

1. Press  2 times as shown in page 4.  
 will be displayed on the remote controller display.

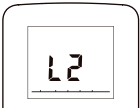

2. Press .

3. Select  using TEMP/SELECT (.

4. Press .

The indoor unit enters the Easy connection mode and [  ] indicator on the indoor unit will blink (on/off = 1 s/1 s).



When the WLAN adapter find a connectable access point, the blinking will become slower (on/off = 2 s/0.5 s).

##### NOTE:

- If the connection to the access point is not be finished in several minutes, the Easy connection mode is canceled and [  ] indicator turns off. In this case, repeat the remote controller setting.

### Temporary deactivation of wireless LAN

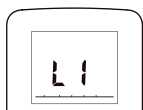

**NOTE:** If you do not press any buttons of the remote controller for 60 seconds, the remote controller display will return to the original display.

1. Press  with the tip of a ballpoint pen or other small object.  
 "L1" will appear.



2. Press .

The current status will appear.

	Activated
	Deactivated

3. Select  using TEMP/SELECT () (\*1).



4. Press .

[  ] indicator on the indoor unit will turn off.

\*1: If you want to activate wireless LAN control again, select "0n" at the step 3.

### Initialization (reset)

Initialize (reset) this product in the following situations:

- Changing the access point
- Disposing this product
- Transferring this product to a third party

#### Unregister the air conditioner

Unregister the air conditioner by using the mobile app. (Refer to the operation manual of the mobile app for details.)

#### Initialization of the WLAN adapter

**NOTE:** If you do not press any buttons of the remote controller for 60 seconds, the remote controller display will return to the original display.

1. Press  3 times as shown in page 4.  
 will be displayed on the remote controller display.

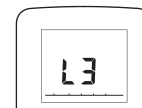

2. Press .

"ln" will appear.



3. Press and hold  for more than 5 seconds.

[  ] indicator on the indoor unit will blink fast, then turn off.

#### To continue use

If you or third party wishes to continue use of the product, follow the procedures in "Air conditioner registration (pairing of WLAN adapter)" to reconnect to a different access point.

##### NOTE:

- Wireless LAN setup is not possible if the previous owner did not unregister or initialize this product. In this case, contact your authorized service personnel.

### Firmware update

#### CAUTION

Do not pull out the power plug nor turn off the circuit breaker during the firmware update of the indoor unit or WLAN device. It may cause malfunction.

#### For WLAN device

The firmware of the WLAN device may be updated automatically.

During the updating, you cannot operate the air conditioner from the mobile app. It will take for a maximum of 5 minutes.

#### For indoor unit

The firmware of the indoor unit may be updated. You can set the schedule of the updating or update the firmware manually from the mobile app. For details, refer to the operation manual for the mobile app.

During the updating, the indicator lamps flash and the air conditioner stops the operation. (Refer to "State of indicator lamps".) It will take for a maximum of 30 minutes.

## 13. TROUBLESHOOTING

### WARNING

-  In the following events, immediately stop operation of the air conditioner, and disconnect all the power supply by turning off the electrical breaker or disconnecting the power plug. Then consult your dealer or authorized service personnel.
- As long as the unit is connected to the power supply, it is not insulated from the power supply even if the unit is turned off.
- Unit smells of something burning or emits smoke
  - Water leaks from the unit

#### Does not operate at all.

- Has there been a power outage?**  
⇒ In this case, the unit restarts automatically after the power supply is resumed. (Refer to **page 7**.)
- Has the circuit breaker been turned off?**  
⇒ Turn on the circuit breaker.
- Has a fuse blown out or the circuit breaker been tripped?**  
⇒ Replace the fuse or reset the circuit breaker.
- Is the timer operating?**  
⇒ To check or deactivate the timer setting, refer to **page 5**.
- <When using the wireless LAN control> Is the WLAN device in a firmware update?  
During the firmware update of the WLAN device, you cannot operate the air conditioner from the mobile app. Operate from the remote controller or wait until the update is complete (for a maximum of 5 minutes).
- <When using the wireless LAN control> Is the indoor unit in a firmware update?  
During the firmware update of the indoor unit, the air conditioner stops the operation. Wait until the update is complete. (for a maximum of 30 minutes).

#### Poor cooling or heating performance.

- Is the unit operating under the conditions except the permissible temperature range?**  
In this case, the air conditioner may stop because of the automatic protection circuit working.
- Is the air filter dirty?**  
⇒ Clean the air filter. (Refer to **page 7**.)
- Is the intake grille or outlet port of indoor unit blocked?**  
⇒ Remove the obstructions.
- Is the room temperature adjusted appropriately?**  
⇒ To change the temperature setting, refer to **page 4**.
- Is a window or door left opened?**  
⇒ Close the window or the door.
- Is the fan speed set to Quiet?**  
⇒ To change the fan speed, refer to **page 4**.
- <In the Cooling mode> **Is direct or strong sunlight shining into the room?**  
⇒ Close the curtains.
- <In the Cooling mode> **Are there other heating apparatus or computers operating, or too many people in the room?**  
⇒ Turn the heating apparatus or computers off, or set the temperature lower. (Refer to **page 4**.)

#### Humidity does not drop during the Dry operation.

- You cannot set the target humidity in the Dry mode. If you feel high humidity, set the temperature lower.

#### Airflow is weak or stops.

- Is the fan speed set to Quiet?**  
⇒ To change the fan speed, refer to **page 4**.
- Has the Fan Control for Energy Saving set? In this case, the indoor unit fan may stop temporarily while the Cooling operation.  
⇒ To cancel the Fan control for energy saving, refer to **page 5**.
- <In the Heating mode> **Have you just started the operation?**  
In this case, the fan rotates at very low speed temporarily to warm up the internal parts of the unit.
- <In the Heating mode> **Is the room temperature higher than the set temperature?**  
⇒ In this case, the outdoor unit stops and the indoor unit fan rotates at very low speed.
- <In the Heating mode> **Is [I] indicator blinking?**  
⇒ In this case, the Automatic defrosting operation is working. The indoor unit stops for maximum of 15 minutes. (Refer to **page 7**.)
- <In the Dry mode> The indoor unit operates at low fan speed to adjust the room humidity, and may stop from time to time.
- <In the Auto mode> While the monitoring operation, the fan rotates at very low speed.

#### Noise is heard.

- Is the unit operating, or immediate after stopping operation?**  
⇒ In this case, refrigerant flowing sound may be heard. It may be particularly noticeable for 2-3 minutes after starting operation.
- Do you hear a slight squeaking sound during the operation?**  
⇒ This sound is produced by the minute expansion and contraction of the front panel caused by temperature change.
- <In the Heating mode> **Do you hear a sizzling sound?**  
⇒ This sound is produced by the Automatic defrosting operation. (Refer to **page 7**.)

#### Smell coming from the unit.

- The air conditioner may absorb various smells generated from interior textile, furniture, or cigarette smoke. These smells may be emitted during the operation.

#### Mist or steam is emitted from the unit.

- <In the Cooling or Dry mode> A thin mist may be generated by condensation formed with sudden cooling process.
- <In the Heating mode> **Is [I] indicator on the indoor unit blinking?**  
⇒ In this case, steam may rise from the outdoor unit because of the Automatic defrosting operation. (Refer to **page 7**.)

#### Outdoor unit emits water.

- <In the Heating mode> The outdoor unit may emit water generated by the Automatic defrosting operation. (Refer to **page 7**.)

#### The unit operates differently from the remote controller setting.

- Are the batteries in the remote controller exhausted?**  
⇒ Replace the batteries.

#### Operation is delayed after restart.

- Has the power supply turned from Off to On suddenly?**  
⇒ In this case, the compressor will not operate for about 3 minutes to prevent a blowout of the fuse.

Immediately stop operation and turn off the electrical breaker in following cases. Then consult authorized service personnel.

- The problem persists even if you perform these checks or diagnostics.
- On the indoor unit, [I] and [⊕] blink while [⊖] is blinking fast.

**NOTE:** For any troubleshooting related to the wireless LAN control, refer to the setting manual for the WLAN adapter or the mobile app installed in your smartphone or tablet PC.

## ■ State of indicator lamps

### NOTES:

- Model 09/12 is reference for the illustrations of indoor unit in this manual, unless otherwise noted.
- Operating procedures are applicable for all models.

📶 : The instruction is relating to the wireless LAN control (optional).

Lighting pattern: Blinking, Any state,

Lighting.

State	Causes and solutions	See page
	Automatic defrosting operation ⇒ Wait until finishing the defrosting (maximum of 15 minutes).	7
(3 times)	Filter indicator ⇒ Clean the air filter and reset the filter sign.	7
(Fast)	Error code display ⇒ Consult authorized service personnel.	-
	Timer setting error because of Auto restart ⇒ Reset the clock and timer settings.	7
	Test run operation (for authorized personnel only) ⇒ Press /I to quit the test run.	-
(Slow)	The power to the access point is not on. ⇒ Check that the power to the access point is on.	-
(Fast)	There is a possibility that the WLAN adapter is not properly connected to the access point. ⇒ Disconnect the power supply to the air conditioner (via breaker or plug), and then re-connect.	8
(Fast)	The firmware of the WLAN device is being updated. You cannot operate the air conditioner from the mobile app. Operate from the remote controller or wait until the update is complete (for a maximum of 5 minutes).	9
	During the air conditioner registration (pairing of WLAN device)	8
	The indoor unit is preparing the firmware update. You cannot operate the air conditioner. Wait until the update is complete (for a maximum of 30 minutes).	9
or	<While the operation is stopped> The indoor unit is in the firmware update. You cannot operate the air conditioner. Wait until the update is complete (for a maximum of 30 minutes).	9
(Slow)	<While the operation is stopped> The firmware update of the indoor unit is complete. The settings from the wireless remote controller are initialized. Control the air conditioner from the wireless remote controller to resend the settings.	9

	<While the operation is stopped> If you cannot operate the air conditioner, the malfunction may occur on the firmware of the indoor unit. Consult authorized service personnel.	-
	Restricted function	-

## ■ Manual Auto operation and Filter indicator reset

You can operate the air conditioner with on the indoor unit.

Status	Length of pressing down	Mode or operation
In operation	More than 3 seconds	Stop
Stopping	2 seconds or less	Filter indicator reset
	More than 3 seconds and less than 10 seconds	Auto
	More than 10 seconds (Only for servicing.) (*1)	Forced cooling

\*1: To stop the forced cooling, press this button or /I on the remote controller.

## ■ Service check

If [] and [] blink while [] is blinking fast on the indoor unit, check the error code. The error code is 2-digit numbers or characters.

1. Press and hold for more than 5 seconds.

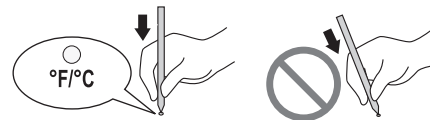

The remote controller will enter to the Service check mode and "

" will be shown.

2. Press TEMP/SELECT () to change the shown error code. The indoor unit emits 1 short beep each time the error code changes. When the corresponding error code is shown, the indoor unit emits multiple beeps and all the indicator lamps on the indoor unit blink.



The characters used for error code					
	A		C		F
	J		P		U

To finish the Service check mode, press /I.

The remote controller will return to the original display. Tell the error code to authorized service personnel when consulting them.

If the indoor unit emits multiple beeps at "00", no error is detected.