



Air conditioner Installation manual

AJ***DNZDCG

- Thank you for purchasing this Samsung air conditioner.
- Before operating this unit, please read this manual carefully and retain it for future reference.

SAMSUNG





Contents

Safety Information	3
Installation	9
Product Inspection	9
Accessories	9
Choosing the installation location	9
Indoor unit installation	12
Refrigerant piping	18
Performing leak test & insulation	19
Additional refrigerant	21
Drain pipe installation	21
Water leakage test	22
Drain pipe insulation	22
Wiring Work	23
Wire Diagram	31
Selecting motor speed	32
Blower CFM tables	33
Connecting External Float switch	36
Installing external outputs	37
Optional : LED Display indicator specifications when checking Wi-Fi Easy Setup and Wi-Fi status	38
Setting the indoor unit addresses and the installation options	39
Final Checks and User Tips	58
Providing information for the user	58
Appendix	61
Troubleshooting	61



Safety Information

California Proposition 65 Warning (US)

⚠ WARNING: Cancer and Reproductive Harm - www.P65Warnings.ca.gov.

IMPORTANT – This product has been designed and manufactured to meet ENERGY STAR criteria for energy efficiency when matched with appropriate coil components. However, proper refrigerant charge and proper air flow are critical to achieve rated capacity and efficiency. Installation of this product should follow the manufacturer's refrigerant charging and air flow instructions. Failure to confirm proper charge and airflow may reduce energy efficiency and shorten equipment life.

⚠ WARNING

- Hazards or unsafe practices that may result in severe personal injury or death.

⚠ CAUTION

- Hazards or unsafe practices that may result in minor personal injury or property damage.
- Carefully follow the precautions listed below because they are essential to guarantee the safety of the equipment.

⚠ WARNING

- Always disconnect the air conditioner from the power supply before servicing it or accessing its internal components.
- Verify that installation and testing operations are performed by qualified personnel.
- Verify that the air conditioner is not installed in an easily accessible area.

Symbol	Meaning
	Flammable gas
	Flammable materials
	Refrigerant safety group
	Read installation manual
	Refer to installation manual
	Read service manual

⚠ WARNING

The installation and testing of this appliance must be performed by a qualified technician.

- The instructions in this manual are not intended as a substitute for proper training or adequate experience in the safe installation of the appliance.

Always install the air conditioner in compliance with current local, state, and federal safety standards.

- Do not use means to accelerate the defrost operation or to clean, other than those recommended by Samsung.
- Do not pierce or burn.
- Be aware that refrigerants may not contain an odor.

Safety Information

General information

WARNING

- Carefully read the content of this manual before installing the air conditioner and store the manual in a safe place to be able to use it as a reference after installation.
- For maximum safety, installers should always carefully read the following warnings.
- Store the operation and installation manual in a safe location and remember to hand it over to the new owner if the air conditioner is sold or transferred.
- This manual explains how to install an indoor unit with a split system with two Samsung units. Using other types of units with different control systems may damage the units and invalidate the warranty. The manufacturer shall not be responsible for damages arising from the use of non-compliant units.
- The manufacturer shall not be responsible for damage from unauthorized changes or improper electrical connections. The requirements outlined in the "Operating limits" table, included in the manual, shall immediately invalidate the warranty.
- All pipe work including piping material, pipe routing, and installation shall include protection from physical damage in operation and service and comply with national and local codes and standards, such as ASHRAE 15, ASHRAE 15.2, IAPMO Uniform Mechanical Code, ICC International Mechanical Code, or CSA B52. Any field joints shall be accessible for inspection before being covered or enclosed.
- The air conditioner should be used only for the applications for which it has been designed: the indoor unit is not suitable to be installed in areas used for laundry.
- Do not use the units if damaged. If problems occur, switch the unit off and disconnect it from the power supply.
- To prevent electric shocks, fires or injuries, always stop the unit, disable the protection switch and contact Samsung's technical support if the unit produces smoke, if the power cable is hot or damaged or if the unit is very noisy.
- Inspect the unit, electrical connections, refrigerant tubes and protections regularly. These operations should be performed by qualified personnel only.
- The unit contains moving parts, which should always be kept out of the reach of children.
- Do not attempt to repair, move, alter or reinstall the unit. If performed by unauthorized personnel, these operations may cause electric shocks or fires.
- Do not place containers with liquids or other objects on the unit.
- The air conditioner contains a refrigerant that must be disposed of as special waste. At the end of its life cycle, the air conditioner must be disposed of in authorized centers or returned to the retailer so it can be disposed of correctly and safely.
- Wear protective equipment (such as safety gloves, goggles, and headgear) during installation and maintenance work. Installation/repair technicians may be injured if protective equipment is not properly equipped.
- This unit is a partial unit air conditioner, complying with partial unit requirements of this International Standard, and must only be connected to other units that have been confirmed as complying with corresponding partial unit requirements of this International Standard.
- This appliance is not intended for use by persons (including children) with reduced physical, sensory or mental capabilities, or lack of experience and knowledge unless they have been given supervision or instruction concerning the use of the appliance by a person responsible for their safety. Children should be supervised to ensure they do not play with the appliance.

Installing the unit

WARNING

IMPORTANT: When installing the unit, always connect the refrigerant tubes first, and then the electrical lines.

- Always disassemble the electric lines before the refrigerant tubes.
- Upon receipt, inspect the product to verify that it has not been damaged during transport. If the product appears damaged, DO NOT INSTALL it, and immediately report the damage to the carrier or retailer (if the installer or the authorized technician has collected the material from the retailer.)
- After completing the installation, always carry out a functional test and provide instructions on how to operate the air conditioner to the user.



- Do not use the air conditioner in environments with hazardous substances or close to equipment that releases free flames to avoid the occurrence of fires, explosions or injuries.
- Do not install the product on a ship or a vehicle (such as a campervan). Salt, vibration or other environmental factors may cause the product to malfunction, electric shock or fire.
- Excessive indoor humidity or clogged condensate drain lines may cause water to drip from indoor units. Do not install the indoor unit where dripping could result in property damage, such as over electronic equipment or other sensitive instruments.
- Our units must be installed in compliance with the space specifications presented in the installation manual to ensure accessibility from both sides and allow repairs or maintenance operations to be carried out. The unit's components must be accessible and easy to disassemble without endangering people and objects.
- For this reason, where it is not observed as indicated in the Installation Manual, the cost necessary to reach and repair the unit (safely as required by local regulations) with slings, trucks, scaffolding or any other means of elevation won't be considered in-warranty and charged to end user.
- If any gas or impurities, except R-32 refrigerant, come into the refrigerant pipe, a serious problem may occur and it may cause injury. Use the supplied accessories, specified components and tools for the installation.
 - Do not use the pipe and the installation product used for the R-22, R-410A refrigerant.
 - Failure to use the specified components can cause the product to fall, water leakage, electrical shock, and fire. (The pipe and flare components used for R-22, R-410A refrigerant must not be used)
- Verify that the voltage and frequency of the power supply comply with the specifications and that the installed power is sufficient to ensure the operation of any other domestic appliance connected to the same electric lines.
- Always verify that the cut-off and protection switches are suitably dimensioned.
- Verify that the air conditioner is connected to the power supply following the instructions provided in the wiring diagram included in the manual.
- Always verify that electric connections (cable entry, section of leads, protections...) are compliant with the electric specifications and with the instructions provided in the wiring scheme. Always verify that all connections comply with the standards applicable to the installation of air conditioners.
- Devices disconnected from the power supply should be completely disconnected in the condition of overvoltage category.

CAUTION

Make sure that you ground the cables.

- Do not connect the earth wire to the gas pipe, water pipe, lightning rod or telephone wire. If grounding is not complete, electric shock or fire may occur.

Install the circuit breaker.

- If the circuit breaker is not installed, electric shock or fire may occur.

Make sure that the condensed water dripping from the drain hose runs out properly and safely.

Install the power cable and communication cable of the indoor and outdoor unit at least 1m away from the electric appliance.

Install the indoor unit away from a lighting apparatus using the ballast.

- If you use the wireless remote control, reception error may occur due to the ballast of the lighting apparatus.
- If the supply cord is damaged, it must be replaced by the manufacturer, its service agent or similarly qualified persons to avoid a hazard.

Do not use the indoor unit for the preservation of food items, plants, equipment, and artwork. This may cause deterioration of their quality.

Do not install the indoor unit if it has any drainage problems.

Power supply line, fuse or circuit breaker

WARNING

- Always make sure that the power supply is compliant with current safety standards. Always install the air conditioner following current local safety standards.
- Always verify that a suitable grounding connection is available.





Safety Information

Precautions for using R-32 refrigerant

General

- This product is pre-charged with mildly flammable gas classified as A2L by ASHRAE. The following precautions and instruction manuals must be followed during installation, operation, servicing and decommissioning of the product.
- The appliance shall be stored in a room without continuously operating ignition sources, like open flames or a gas appliance or an electric heater.
- All national and local regulations shall be observed at all times.
- All pipe-work including piping material, pipe routing and installation shall include protection from physical damage in operation and service, and comply with national and local codes and standards, such as ASHRAE 15, ASHRAE 15.2, IAPMO Uniform Mechanical Code, ICC International Mechanical Code, or CSA B52. All field joints shall be accessible for inspection before being covered or enclosed.
- All field piping and joints shall be pressure tested with an inert gas according to prevalent industry standards before refrigerant charging and system commissioning.
- Where additional field charging is required. The installer shall write with a permanent marker the field charge added on the ODU label provided, such that the Total Charge = Factory 'Pre-charge' + field charge.
- For ducted systems, any auxiliary systems that are potential ignition sources shall not be installed in the duct work. Examples of ignition sources are hot surfaces with temperatures exceeding 1,292°F (700°C) and electric switching devices.
- Any auxiliary device installed must be approved by Samsung and must be suitable for operating with the refrigerant marked on the label.
- For mechanical ventilation the lower edge of the air extraction opening shall not be more than 100mm above the floor. The exhaust location outside the building must be at least 3 m away from the building opening and mechanical air intake openings.
- To handle, purge, and dispose of the refrigerant, or break into the refrigerant circuit, the worker should have a certificate from an industry-accredited authority.
- Non-ducted systems may be installed in areas such as false ceilings not being used as return air plenum if the conditioned air does not mix with the air in the false ceilings.
- For ducted appliances false ceilings or drop ceilings may be used as return air plenum if a refrigerant leak detection system is provided in the system and any external connections are also provided with a sensor immediately below the return air plenum duct joint.

- Installation, servicing, and any type of maintenance or repair must be performed by certified personnel who are competent to carry out such activity following national and local regulations.
- Minimum floor area of the room shall be in compliance with the minimum room area according to the total charge of the installation according to <Table 1> in the outdoor unit installation manual.

General information on Servicing

- Do not work in a confined space. Ensure adequate ventilation is provided at the workspace during the entirety of the duration of the work to safely disperse any released refrigerant.
- All maintenance staff and others working in the local area shall be instructed on the nature of the work being performed and instructed to follow all instructions provided by Samsung, national and local authorities.
- The area shall be checked with an approved refrigerant detector before and during any work on the system.
- Have a dry CO₂ fire extinguisher adjacent to the charging area and workspace.
- The service personnel shall not use any ignition sources in a manner that may lead to the risk of fire or explosion.
- Potential ignition sources shall be kept away from the work area where the flammable refrigerant can be released into the surrounding area.
- The work area should be checked to ensure that there are no flammable hazards or ignition risks. The "No Smoking" sign shall be attached.
- Under no circumstances shall potential sources of ignition be used upon detection of leakage.

The following checks shall be applied to installations and maintenance operations.

- The actual total refrigerant charge is in accordance with the room size in accordance with Table 1.
- The ventilation machinery and outlets are operating adequately and are not obstructed.
- Markings on the equipment are visible and legible.
- Refrigerant pipes or components are installed in a position where they are unlikely to be exposed to any substance that may corrode refrigerant containing components.

Initial checks of electrical devices shall include the following.

- that capacitors are discharged safely to avoid sparking.
- that no live electrical components and wiring are exposed while charging, recovering or purging the system.
- That there is continuity to earth bonding.
- Check that cabling is not worn, corroded or damaged in any manner.





Electrical repair safety measures

- All electrical components used or replaced must be to Samsung's specifications.
- If a fault exists that could compromise safety, then no electrical supply shall be connected to the circuit until it is satisfactorily dealt with.
- Sealed electrical components and intrinsically safe components shall be replaced and not repaired.
- Cabling should be protected from excessive vibration, pressure, sharp edges, and other adverse environmental factors.

Detection of flammable refrigerants

- Electronic leak detectors shall be used to detect flammable refrigerants, but the sensitivity may not be adequate or may need re-calibration. (Detection equipment shall be calibrated in a refrigerant-free area.)
- Make sure that the detector is not a potential source of ignition.
- Leak detection equipment shall be set at a percentage of the LFL (Lower flammable limit) of the refrigerant and shall be calibrated to the refrigerant employed and the appropriate percentage of gas (25% maximum) is confirmed.
- The use of detergents containing chlorine shall be avoided for cleaning because the chlorine may react with the refrigerant and corrode the piping.
- If leakage is suspected, naked flames shall be removed.
- If a leakage is found while brazing, the entire refrigerant shall be recovered from the product or isolated (e.g. using shut-off valves). It shall not be directly released into the environment. Oxygen-free nitrogen (OFN) shall be used for purging the system before and during the brazing process.
- The work area shall be checked with an appropriate refrigerant detector before and during work.
- Ensure that the leakage detector is appropriate for use with flammable refrigerants.

Removal and Evacuation

- When removing refrigerant for servicing it is recommended to remove the entire quantity.
- When removing refrigerant follow local and national regulations and follow best practices including;
 - evacuate;
 - purge the circuit with inert gas (optional for A2L);
 - evacuate (optional for A2L);
 - continuously flush or purge with inert gas when using a flame to open the circuit; and
 - open the circuit.

- Use proper recovery cylinders appropriate for the type of refrigerant.
- Follow prescribed industry best practices for purging and evacuation.
- Oxygen free nitrogen shall be used for purging the system.

Charging procedure

- Follow industry standard refrigerant charging best practices.
- Before recharging the system shall be pressure tested with oxygen free nitrogen gas.
- Ensure that contamination of different refrigerants does not occur when charging.
- Cylinders shall be kept in the appropriate position as per instructions.
- The refrigerant system should be grounded before charging the system.
- Label the system when charging is completed.
- Take extreme care not to overfill the refrigeration system.
- The system shall be leak tested on completion of charging before commissioning.

Decommissioning

- Only qualified licensed professionals shall perform refrigerant recovery and decommissioning.
- Isolate the system electrically.
- All recovery equipment and cylinders shall conform to appropriate standards. Only approved cylinders, with pressure relief valves, for the type of refrigerant shall be used.
- Recover refrigerant following industry standard procedure for flammable refrigerants.
- When draining compressors oil care must be taken that there is no flammable refrigerant in the compressor and that the compressor is not hot. Oil should be handled according to local and federal regulations.
- After decommissioning, the system shall be labeled stating that it has been decommissioned. The label shall be dated and signed. The label should state that it "contains flammable refrigerant".
- Ensure that there are labels on the equipment indicating the equipment contains flammable refrigerant.
- Recovered refrigerant shall not be mixed or reused. It shall be processed according to national, state and local regulations.





Safety Information

About Refrigerant Detection System (RDS)

- This system includes a refrigerant detection system (RDS) and automatic leak mitigation controls.
- When a leak is detected, the RDS will stop the compressor and energize the indoor unit(s) fan for air circulation to disperse the leaked gas and display an error code.
- The RDS sensor does automatic self-test each hour and does not require any periodic maintenance.
- The sensor should be replaced upon end of life when error code E700 is displayed.
For complete replacement instructions, please refer to the Service Manual.
- The RDS sensor must only be replaced with sensors as specified by Samsung. Sensor replacement must be performed by a certified technician.
- MIM-B14U (sold as accessory) which may be used to energize external ventilation fans, as applicable, and close any zone dampers which may be installed in the ductwork, as applicable.
- LEAK DETECTION SYSTEM installed. Unit must be powered except for service.





Product Inspection

As soon as the air handler is received, it should be inspected for possible damage during transit. If damage is evident, the extent of the damage should be noted on the carrier's freight bill. A separate request for inspection by the carrier's agent should be made in writing. Before installing the air handler you should check the cabinet for screws or bolts which may have loosened in transit. There are no shipping or spacer brackets that need to be removed before startup. See the local Distributor for more information. Samsung assumes no liability for freight damage. Also check to be sure all accessories such as heater kits, and coils are available. Installation of these accessories should be accomplished before the air handler is set in place or the connecting of the wiring, electric heat, ducts or piping.

Accessories

The following accessories are supplied with the indoor unit.

User manual	Installation manual	Warranty card
		

Choosing the installation location

Installation location requirements

- There must be no obstacles near the air inlet and outlet.
- Install the indoor unit on a ceiling that can support its weight.
- Maintain sufficient clearance around the indoor unit.
- Before installing the indoor unit, be sure to check whether the chosen location is well-drained.
- The indoor unit must be installed such that it is beyond public access and is not touchable by users.
- A vibration-resistant location that is not inclined (If the indoor unit is installed on a structure that is not sturdy, it may fall and get damaged or cause injury.)
- Where it is not exposed to direct sunshine.
- Where the air filter can be removed and cleaned easily.
- A location where animals cannot access and urinate on the product. Ammonia may be generated.

Installation



Choosing the installation location

⚠ WARNING

- Because your air conditioner contains R-32 refrigerant, make sure that it is installed, operated, and stored in a room whose floor area is larger than the minimum required floor area specified in the following table:

<Table 1>

m [lbs(kg)]	Minimum required room area [A, ft ² (m ²)]	
	Reference Height [h ₀ , ft(m)]	
	Floor-standing (with R-32 sensor)	
	1.97(0.6)	
≤ 4.047(1.836)	- no room area restrictions -	
4.049(1.837)	215(20.0)	
4.18(1.9)	223(20.7)	
4.40(2.0)	235(21.8)	
4.85(2.2)	258(24.0)	
5.29(2.4)	281(26.1)	
5.73(2.6)	305(28.3)	
6.17(2.8)	328(30.5)	
6.61(3.0)	352(32.7)	
7.05(3.2)	375(34.9)	
7.49(3.4)	399(37.0)	
7.93(3.6)	422(39.2)	

- m : Total refrigerant charge in the system
- A : Minimum required floor area
- Calculated in accordance with UL 60335-2-40 Annex GG

- IMPORTANT: It's mandatory to either follow the table above or follow the federal, state, and/or local regulations regarding the minimum room area allowed for the total refrigerant charge in the system.
- The actual refrigerant charge shall be per the room size within which the refrigerant-containing parts are installed.
- The ventilation machinery and outlets shall be operating adequately and not obstructed.
- If an indirect refrigerating circuit is being used, the secondary circuit shall be checked for the presence of refrigerant.
- Marking the equipment shall continue to be visible and legible. Markings and signs that are illegible shall be corrected.
- Refrigerating pipes or components shall be installed in a position where they are unlikely to be exposed to any substance that may corrode refrigerant-containing components unless the components are constructed of materials that are inherently resistant to being corroded or are suitably protected against being so corroded.

⚠ CAUTION

- As a rule, the unit cannot be installed at a height of less than 1.97ft (0.6m).
- If you install a cassette type indoor unit on the ceiling when the temperature is over 80.6°F (27°C) and humidity is over 80%, you must apply an extra 0.39inch (10mm) thick polyethylene insulation or a similar type of insulation to the body of the indoor unit.

Do not install the air conditioner in the following places.

- A place where there is mineral oil or arsenic acid. resin parts flame and the accessories may drop, or water may leak. The capacity of the heat exchanger may be reduced, or the air conditioner may be out of order.
- A place with exposure to mineral oil, oil vapor or a cooking area where there is spray (If oil adheres to the heat exchanger, performance degradation, spray or condensation scattering may occur. If oil adheres to a plastic component, the component may deform or get damaged. Such issues may result in a system failure or refrigerant leak.)
- A place with aromatic diffusers, aromatherapy, scented candles or perfumes as the chemicals may react to the product's materials and may result in system failure or refrigerant leaks.
- The place where corrosive gas such as sulphuric acid gas is generated from the vent pipe or air outlet.
- The copper pipe or connection pipe may corrode and the refrigerant may leak.
- The place where there is a machine that generates electromagnetic waves. The air conditioner may not operate normally due to the control system.
- The place where there is a danger of existing combustible gas, carbon fiber or flammable dust.
- The place where thinner or gasoline is handled. Gas may leak and it may cause fire.
- The place that is close to heat sources.
- Do not use the indoor unit for the preservation of food items, plants, equipment, and artwork. This may cause deterioration of their quality.
- Do not install the indoor unit if it has any drainage problems.



Dimensions

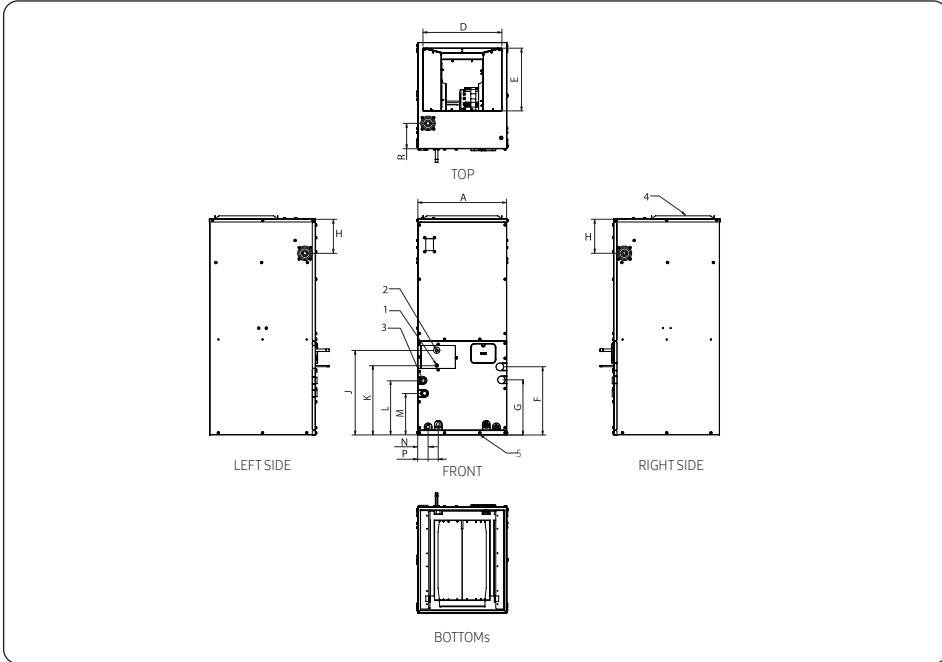

DIMENSIONAL DATA MULTI-POSITION AIR HANDLER																
MODEL		A	B	C	D	E	F	G	H	J	K	L	M	N	P	R
AJ012DNZDCG	inch	17.50	43.00	21.00	15.50	12.50	13.50	11.00	6.75	16.75	14.00	11.00	8.50	2.00	4.00	2.00
AJ018DNZDCG																
AJ024DNZDCG	mm	444.50	1092.20	533.40	393.70	317.50	342.90	279.40	171.45	425.45	355.60	279.40	215.90	50.80	101.60	50.80

NOTE

- ALL DIMENSIONS ARE IN INCHES AND ARE APPROXIMATE. ALL DIMENSIONS ARE ROUNDED

No.	Name	Description
1	Liquid pipe connection	**012/018/024** : $\Phi 1/4"$ ($\Phi 6.35\text{mm}$)
2	Gas pipe connection	**012** : $\Phi 3/8"$ ($\Phi 9.52\text{mm}$)
		018 : $\Phi 1/2"$ ($\Phi 12.7\text{mm}$)
		024 : $\Phi 5/8"$ ($\Phi 15.88\text{mm}$)
3	-	3/4" NPT ($\Phi 19.05\text{mm}$)
4	-	-
5	-	-

Installation





Indoor unit installation

Refrigerant pipe work must be done before installing the indoor unit.

Location

Access to servicing is an important factor in the location of any air handler. Provide a minimum of 30 inches (762mm) in front of the appliance for access to the control box, heating elements, blower and air filters. This access may be provided by a closet door or by locating the appliance so that a wall or partition is not less than 30 inches (762mm) from the front access panel. Location is usually predetermined. Refer to the figure below. Check with the owner's or dealer's installation plans. If the location has not been decided, consider the following in choosing a suitable location.

- 1 Select a location with adequate structural support, space for service access, and clearance for return and supply duct connections.
- 2 Normal operating sound levels may be objectionable if the air handler is placed directly over or under some rooms such as bedrooms, study, etc.
- 3 Caution should be taken to locate the unit so that supply and return air ducts are about the same length causing even air distribution of supply and return air to and from the living spaces.
- 4 Locate the appliance where electrical supply wiring can be easily routed to the main electrical panel and where electrical wiring will not be damaged.
- 5 Locate the appliance where control wiring can be easily routed to the controller and where the wiring will not be damaged.
- 6 Locate the appliance where refrigerant lines can be easily routed from the evaporator coil to the system.
- 7 Locate the appliance where condensate lines can be easily routed to an available drain. Be sure to route condensate drain piping so as not to obstruct access to the air filter.
- 8 The coil is installed in a draw-thru application and will create a negative pressure situation in the condensate drain system. To prevent condensate from being drawn into the blower it is recommended to trap the primary (Main) and secondary (Overflow) drain line. Refer to the Drain Pipe and Drain Hose section in these instructions. If the secondary drain is not used, it must be capped. This unit has a connection terminal for drain system monitoring. Refer to the Wiring Work section for information regarding the connection of field-provided condensate overflow devices in these instructions.
- 9 The draw-thru design will cause the exterior surface of the cabinet to sweat when the unit is installed in a non-conditioned space such as an attic or garage. The installer must provide protection such as a full size auxiliary drain pan on all units installed in a non-conditioned space to prevent damage from condensation runoff. Some states, cities and counties require additional insulation to be installed on the exterior casing of the air handler to prevent sweating. Refer to the state, city, county or local code for insulation requirements to be sure the installation complies. It is recommended that air handlers installed in non-conditioned spaces be insulated on the exterior of the entire cabinet, including the front access panel with one (1) inch (25.4mm) thick fiberglass with the vapor barrier on the outside.
- 10 Ensure sufficient space for the bottom of the product (H dimension) so that a downward slope of 1/100 can be maintained for drain piping, as described for the intake duct installation and in "Drain pipe installation".

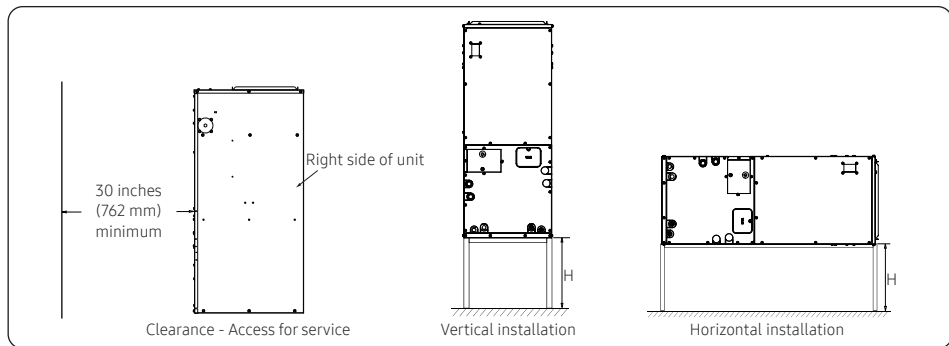



This appliance is approved for zero (0) inches (0mm) clearance to combustible material on any part of the air handler exterior casing and the inlet or outlet ducts providing NO electric heater is being used. There is a one (1) inch (25.4mm) clearance on the supply plenum and supply air duct when an electric heater is installed in the appliance. Refer to the Table below for clearance of combustibles information.

Unit : inch (mm)

Top	Back	Sides	Front of unit		Duct
			Alcove	Closet	
0 (0)	0 (0)	0 (0)	30 (762)	6 (152.4)	1 (25.4) *

* when the electric heat kit accessory is installed

Return air requirements

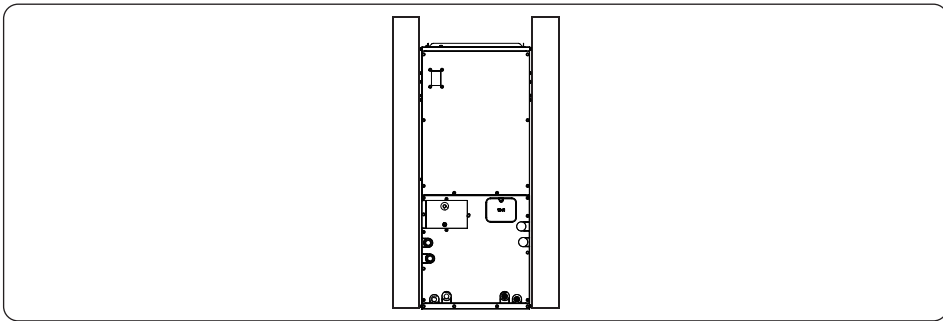

Installation

Return Air Requirements

For the air handler to work properly, a closet or alcove must have a certain total free area opening for the return air.

For A/C and HP Air Handlers 1/3 HP Blower Motor

Minimum 200 in² (0.129 m²) free area opening

- Use a Return Grille that can supply sufficient air to ensure proper performance.

The return air opening can be on the floor, on a closet front door or a side wall above the air handler casing. If the opening for the return air is in the floor, side walls, or closet door anywhere below the appliance casing, a 6 inches (152.4mm) minimum clearance between the appliance and the wall or door must be provided on the side where the return is located to provide for proper air flow. The 6 inches (152.4mm) minimum clearance is not required if there is a return grille installed above the appliance casing, providing the grille has a sufficient return air opening.





Indoor unit installation

Return air requirements

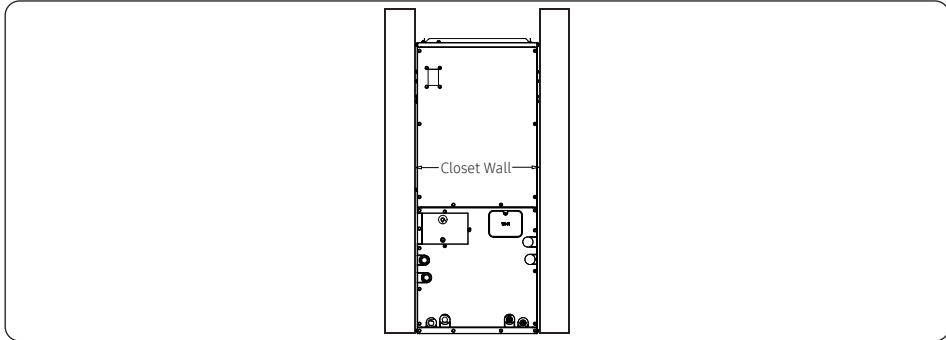

Typical Closet Installations

Provisions shall be made to permit the air in the rooms and the living spaces to return to the air handler. Failure to comply may cause a reduction in the amount of return air available to the blower, causing reduced air flow and resulting in improper heating and cooling of the living space. The reduced air may cause the air flow handler to cycle on the limit causing premature heating element failure (if electric heat kits are installed).

Upflow Accessory Filter Box Kit

An accessory filter box kit can be used on the return air end of the air handler when configured in the upflow position. The filter kit is placed over the return plenum in the floor and sealed to the plenum using sealant or caulking material and/or tape. The air handler is placed on top of the return filter box and the return opening is sealed to prevent leaks.

NOTE

- Make sure the flow arrow on the air filter is pointing towards the coil.

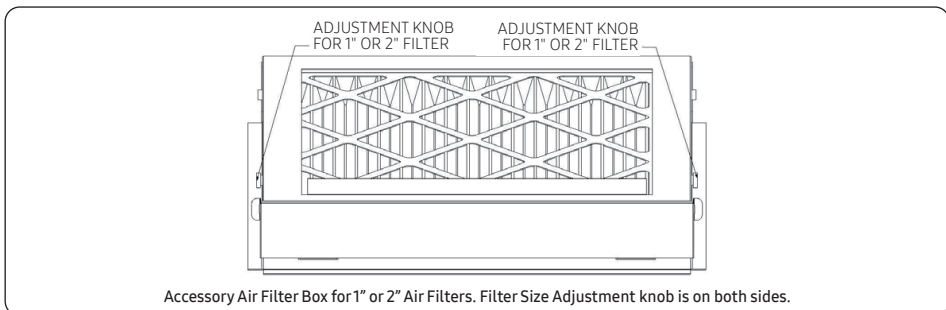

FILTER BASE ASSEMBLY KIT MODEL NUMBERS - FIELD INSTALLED, PURCHASED SEPARATELY

VFB-1 – 16" X 20" X 2" Small Cabinet (12/18/24K)





Arrangement

Unit shipped from the factory are arranged to be installed in an upflow or horizontal left (right to left air flow) position. The horizontal left means when the unit is laid on its side and you are facing the unit, the supply air opening is to the left and the return opening is to the right. These models are field convertible to a horizontal right (left to right) air flow position.

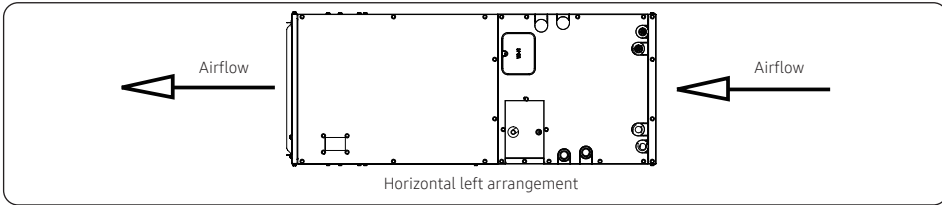

Upflow application

In an upflow installation the discharge outlet is at the top. Care should be taken to ensure the unit is level to permit proper condensate drainage. Normal upflow installation will be in a closet or basement. If installed in a closet, it must have a platform framed in. The platform must have an opening centered in the closet that measures at least 12 inches (304.8mm) in height from the floor. A filter frame and filter can be used that covers the opening and is sealed to prevent air from bypassing the filter. A filter grille can be used that is located as described in the RETURN AIR REQUIREMENTS section. The minimum filter size is shown in the table below.

Standard throw away air filter @ 300 ft/min (91.44 m/min) or less

800 CFM = 20 x 20 x 1
1000 CFM = 20 x 25 x 1
1200 CFM = 20 x 30 x 1
1400 CFM = 25 x 30 x 1
1600 CFM = 25 x 30 x 1
1800 CFM = 30 x 30 x 1
2000 CFM = 30 x 40 x 1 or two 30 x 20 x 1
2400 CFM = 30 x 40 x 1 or two 30 x 20 x 1

Pleated Air Filter @ 500 ft/min (152.4 m/min) or less

800 CFM = 16 x 16 x 1
1000 CFM = 18 x 20 x 1
1200 CFM = 20 x 20 x 1
1400 CFM = 20 x 20 x 1
1600 CFM = 20 x 25 x 1
1800 CFM = 20 x 30 x 1 or two 20 x 15 x 1
2000 CFM = 20 x 30 x 1 or two 20 x 15 x 1
2400 CFM = 25 x 30 x 1 or two 14 x 30 x 1

Another option is to use the Filter Base Accessory Kit. This filter base is placed on the closet floor and secured with screws. The unit is placed on top of the filter base and secured to the base with screws. Use seal strip, tape or calking to seal between the unit and the base.

Connect the supply air outlet to a plenum at the top of the unit and secure it with screws. Use a Non-tape sealant such as mastic or an aerosol sealant to seal duct leakage. If installed in a basement, run supply and return duct work following local codes. Use a Non-tape sealant such as mastic or an aerosol sealant to seal duct leakage.





Indoor unit installation

Horizontal application

Horizontal applications will normally be used in an attic or crawl space. This type of installation requires a supply air plenum or duct to be connected to the supply collar and a return air plenum or duct to be attached to the unit inlet collar. The supply ducts will be connected to the supply air plenum and routed through the attic to a register in each room. Use a Non-tape sealant such as mastic or an aerosol sealant to prevent leaks in the ducts and the plenum.

The opposite end of the return air duct is attached to a return filter grille housing. The filter grille is usually located on a wall, just below the ceiling or the ceiling in a hallway. Use a Non-tape sealant such as mastic or an aerosol sealant to prevent leaks in the ducts and the plenum.

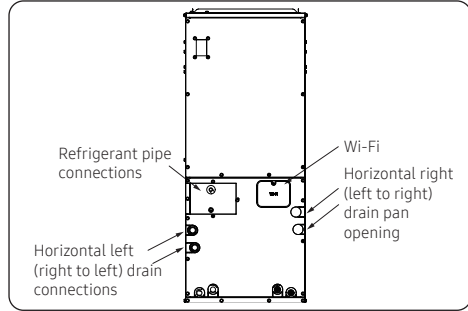

Horizontal right application (left to right)

The unit is shipped to be installed without modification in a horizontal left configuration. For horizontal right applications:

- 1 Remove the unit access panels
- 2 Remove the cooling coil after disassembling the bracket coil and plate.
- 3 Move the condensate drain pan to the right side of the unit chassis.
- 4 Move the Evap In temperature sensor to the holder on the right side.
- 5 Reinstall the cooling coil and attach the refrigerant detection sensor on the right side of the coil as shown on the following page.
- 6 Connect the condensate drains and refrigerant lines. DRY NITROGEN MUST BE FLOWED THROUGH REFRIGERANT LINES DURING SOLDERING OPERATION.
- 7 Reinstall unit access panels.
 - ※ In all horizontal applications in which the unit is installed above a finished ceiling and/or living space, it is recommended that a secondary drain pan (field supplied) is installed under the entire unit to avoid damage to the ceiling in the event of a condensate overflow.
 - ※ When removing the cooling coil, make sure to pull the lower drain pan. If you hold the pipe and remove the cooling coil, the pipe may be damaged.

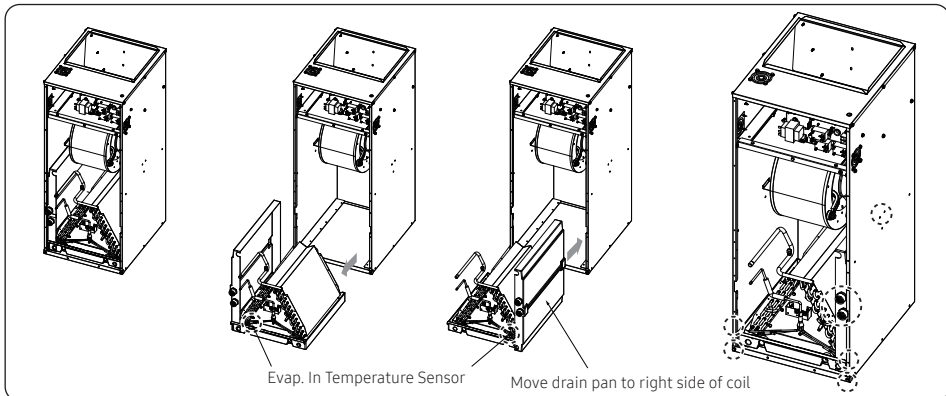



How to change the position of the wires and refrigerant detection sensor

⚠ WARNING

- It is mandatory to relocate the refrigerant detection sensor when installing this unit in horizontal-right applications. Failure to relocate the sensor can result in unsafe concentrations of A2L refrigerant, creating a fire risk.

Please change the position of the refrigerant detection sensor as shown in the image below.

Please proceed with the fixing way of the wires according to the position of the drain pan as shown in the image below.

Use a cable tie to attach the refrigerant detector wires to the hairpin on the left side of the refrigerant dedection sensor.

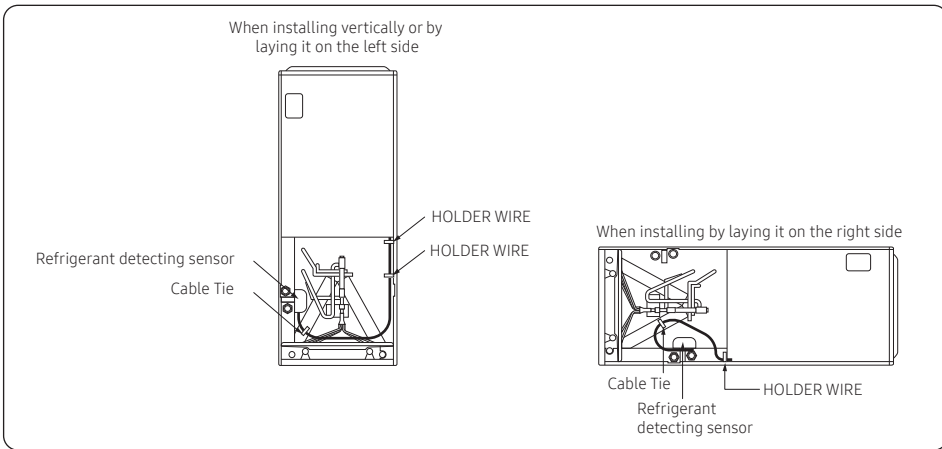

Closet installation

Before installing the air handler make sure holes are cut into the floor for refrigerant tubing, drain line, electrical wiring, and control wiring.

- 1 Remove the top shipping cover and corner posts.
- 2 Remove the bottom shipping cover.
- 3 Remove the blower and control box access panel (door).
- 4 Remove the coil compartment access panel (door).
- 5 Place the unit into position by sliding the unit over the duct opening until the opening in the unit lines up with the duct opening on the floor.
- 6 Secure the unit to the floor by drilling two holes through the air handler base at the left and right front inside corners of the cabinet. Use two screws to secure the unit to the floor.
- 7 Use caulking, sealers, and/or tape to seal between the floor base and the opening on the unit or between the opening on the unit and the duct in the floor.
- 8 Connect the electrical supply wires and the control wires in the control box.
- 9 Connect the refrigerant lines to the coil. DRY NITROGEN MUST BE FLOWED THROUGH REFRIGERANT LINES DURING SOLDERING OPERATION.
- 10 Re-install the coil compartment access panel (door) and secure it with the screws that were removed in step 3.
- 11 Re-install the blower and control box access panel (door) and secure with the screws that were removed in step 2.





Refrigerant piping

Air Handlers with DX type evaporator coils require liquid and suction piping sized following the condensing unit manufacturer's instructions. The evaporator coils have sweat copper connections. Refrigerant lines should be soldered with silver solder or high temperature brazing alloy.

DRY NITROGEN MUST BE FLOWED THROUGH REFRIGERANT LINES DURING SOLDERING OPERATION.

REFER TO OUTDOOR UNIT INSTALLATION MANUALS FOR PRESSURE CHECKING AND VACUUM DRYING PROCEDURES.

There are two refrigerant pipes of differing diameters:

- A smaller one for the liquid refrigerant
- A larger one for the gas refrigerant

The inside of the copper pipe must be clean & have no dust.

- Prepare the connecting pipe referring to the list below.
- Refrigerant pipe diameters

Unit : inch (mm)

	AJ012DNZDCG	AJ018DNZDCG	AJ024DNZDCG
Liquid pipe	Φ1/4 (Φ6.35)	Φ1/4 (Φ6.35)	Φ1/4 (Φ6.35)
Gas pipe	Φ3/8 (Φ9.52)	Φ1/2 (Φ12.70)	Φ5/8 (Φ15.88)

Cutting the pipes

- 1 Make sure that you prepare the required tools. (pipe cutter, reamer, airing tool and pipe holder)
- 2 If you want to shorten the pipe, cut it using a pipe cutter ensuring that the cut edge remains at 90° with the side of the pipe. There are some examples of correctly and incorrectly cut edges below.

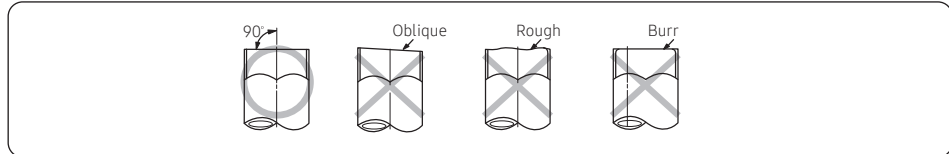



Performing leak test & insulation

Leak test

LEAK TEST WITH NITROGEN (before opening valves)

To detect basic refrigerant leaks, before recreating the vacuum and recirculating the R-32, it's the responsibility of the installer to pressurize the whole system with nitrogen (using a pressure regulator) at a pressure above 29.0 PSI (0.2 MPa), less than 595 PSI (4.1 MPa)

LEAK TEST WITH R-32 (after opening valves)

Before opening valves, discharge all the nitrogen in the system and create a vacuum. After opening valves check leaks using a leak detector for refrigerant R-32.

⚠ CAUTION

- Discharge all the nitrogen to create a vacuum and charge the system

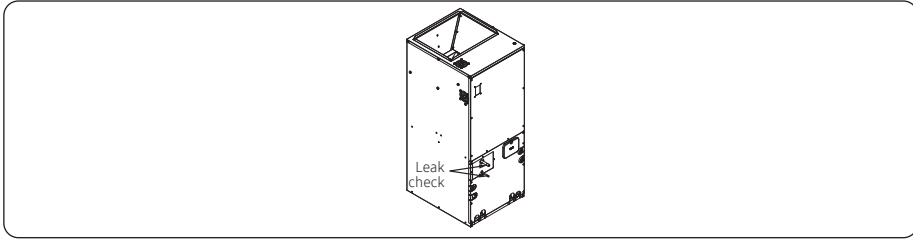

Insulation

Once you have checked that there are no leaks in the system, you can insulate the piping and hose.

- 1 To avoid condensation problems, place **0.51" (T13.0mm) or thicker Acrylonitrile Butadiene Rubber** separately around each refrigerant pipe.
 - You can contact the gas side and liquid side pipes but the pipes should not be pressed together tightly.
 - When contacting the gas side and liquid side pipe, use a 1 grade thicker insulator.

📄 NOTE

- Always make the seam of pipes face upwards.
- 2 Wind insulating tape around the pipes and drain hose to avoid compressing the insulation too much.
 - 3 Finish wrapping insulating tape around the rest of the pipes leading to the outdoor unit.
 - 4 The pipes and electrical cables connecting the indoor unit with the outdoor unit must be fixed to the wall with suitable ducts/straps.

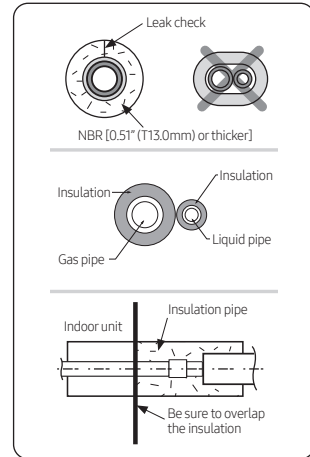

⚠ CAUTION

- All refrigerant connections must be accessible, to permit either unit maintenance or removing it completely.

⚠ CAUTION

- Must fit tightly against the body without a gap.



Performing leak test & insulation

- 5 Select the insulation of the refrigerant pipe.
 - Insulate the gas side and liquid side pipe referring to the thickness according to the pipe size.
 - Indoor temperature of 86 °F(30 °C) and humidity of 85% is the standard condition. If installed in a high humidity condition, use one grade thicker insulator by referring to the table below. If installing in unfavorable conditions, use a thicker wall insulation.
 - The insulator's heat-resistance temperature should be more than 248 °F (120 °C).

Pipe	Outer diameter		Insulation Type (Cooling/Heating)				Remarks
			General [86°F (30°C), 85% or below]		High humidity [86°F (30°C), more than 85%]		
	inch	mm	EPDM, NBR				
	inch	mm	inch	mm	inch	mm	
Liquid pipe	1/4~3/8	6.35~9.52	3/8	9	3/8	9	Internal temperature is higher than 248°F (120°C)
	1/2~2	12.7~50.8	1/2	13	1/2	13	
Gas pipe	1/4	6.35	1/2	13	3/4	19	
	3/8~1	9.52~25.4	3/4	19	1	25	
	1 1/8~1 3/4	28.58~44.45	3/4	19	1 1/4	32	
	2	50.8	1	25	1 1/2	38	

- When installing insulation in places and conditions below, use the same insulation that is used for high humidity conditions.
 - ◀Geological condition▶
 - High humidity places such as shorelines, hot springs, near lakes or rivers, and ridges (when part of the building is covered by earth and sand.)
 - ◀Operation purpose condition▶
 - Restaurant ceiling, sauna, swimming pool etc.
 - ◀Building construction condition▶
 - The ceiling frequently exposed to moisture and cooling is not covered.
e.g. The pipe installed in a corridor of a dormitory and studio or near an exit that opens and closes frequently.
 - The place where the pipe is installed is highly humid due to the lack of a ventilation system.



Additional refrigerant

- System refrigerant volume is based on linear feet of liquid line pipe and indoor equipment model/quantity.
- Refer to the outdoor unit installation manuals for information regarding refrigerant volume for system components.

Drain pipe installation

The air handler "A" coil drain pan has two $\frac{3}{4}$ " NPT ($\Phi 19.05\text{mm}$) female primary and two secondary connections (left or right hand). The horizontal pan has two $\frac{3}{4}$ " NPT ($\Phi 19.05\text{mm}$) females, one primary and one secondary. Piping from each fitting used is to have 2 inches (50.8mm) minimum trap and each runs in such a manner as to provide enough slope for adequate drainage to a visible area. Do not pipe these two fittings together into a common drain. Prime drain with water before operating the unit by pouring water into the condensate pan. Cap unused connections.

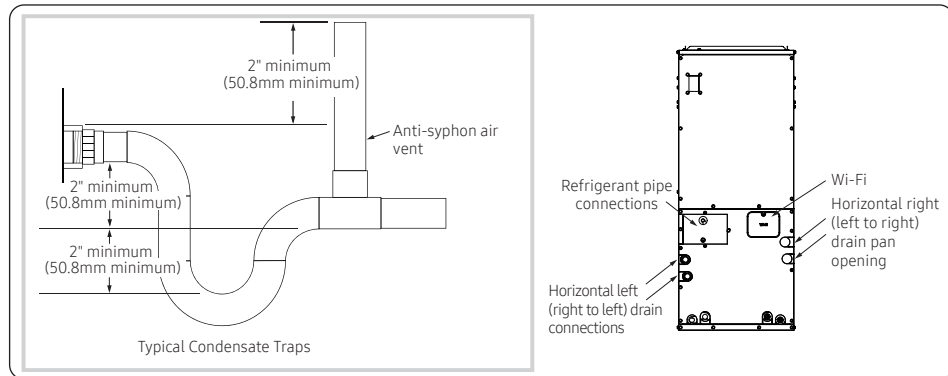

⚠ CAUTION

- Make sure to keep the drain hose from getting tangled or loosened (on the connection part).
- Insulate all condensate pipes connected to the indoor unit to prevent condensation formation. Condensate formation on condensate pipes can lead to property damage and unsafe environmental conditions.

When passing the drain hose through the hole drilled in the wall, make sure to avoid the following cases.

⚠ CAUTION

- Since the draining is of natural drain type, install the drain hose in a downward direction.
- If you do not tie the drain hose with a cable tie, leakage may occur
- The drain pipe may get clogged if there are any foreign substances within the drain pan, so you must remove any foreign substances after completing the installation.





Water leakage test

- 1 Pour water into the condensate pan.
- 2 Make sure that draining is done properly by checking the end of the drain pipe.
- 3 If water leakage occurs, make sure the indoor unit is level. Also, verify the drain pipe is installed with a downward slope away from the indoor unit.

CAUTION

- After connecting the drain pipe to the indoor unit, you must perform a leak test. If the drain test is not done properly, water may get into the indoors and cause property damage.
- Empty the condensation water in the drain pan before any repair/maintenance service.

Drain pipe insulation

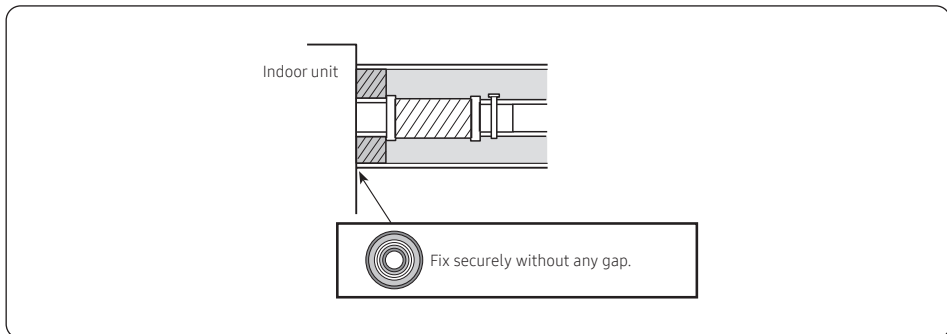

CAUTION

- You must insulate drain pipes.
- Make sure to prevent any gap between the insulation on drain pipe elbows.
- Make sure that insulation is overlapped.



Wiring Work

⚠ WARNING

- For personal safety be sure to turn the electrical power "OFF" at the main entrance (Home Circuit Breaker Box) and at the unit control box circuit breakers before attempting any service or maintenance operations. Homeowners should never attempt to perform any maintenance that requires opening the air handler control box door.
- This air handler is not equipped with a shield that covers the line voltage electrical supply wires and the circuit breaker connections. Take precautions to prevent accidental electrical shock. Be sure to turn the electrical power "OFF" at the main entrance (Home Circuit Breaker Box) and the control box circuit breakers before removing the front panel.

Power supply wiring

- The unit's internal wiring is complete except for the power supply and control wires.
- The use of cable connectors on incoming power supply wires to relieve any strain on wiring is recommended.
- Follow the steps below to connect the power supply wires.
- Supply voltage is 208/230V, 1 ϕ , 60 Hz.
- If you are installing optional heat kits, refer to the heat kit installation instructions for line voltage connection instructions

Wiring diagram

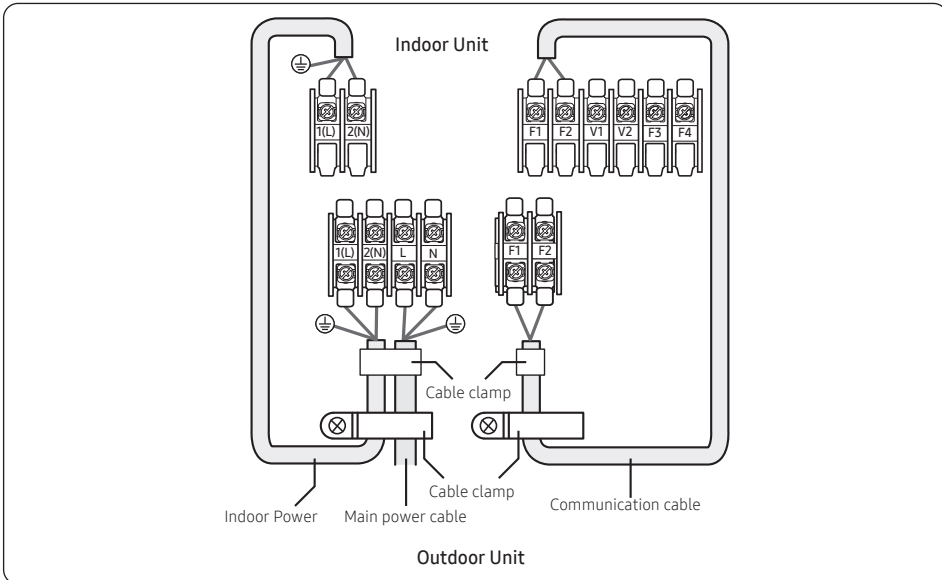

Installation

Wiring Work

Between Indoor and Outdoor Connection cable Specifications (Common in use)

Indoor Power supply			Communication Cable
Power Supply	Max/Min(V)	Indoor Power cable	
208-230V/60Hz	± 10%	AWG 14 ↑, 3 wires	AWG 18 ↑, 2 wires

- Selecting wire size must comply with local and national codes.
- Power supply cords of parts of appliances for outdoor use shall not be lighter than polychloroprene sheathed flexible cords. (Code designation IEC:60245 IEC 57 / CENELEC: H05RN-F or IEC:60245 IEC 66 / CENELEC: H07RN-F)
- Screws on the terminal block must not be unscrewed with torque less than 12 kgf•cm (0.86 lbf•ft).
- Since it has an external power supply, refer to the outdoor unit installation manual for MAIN POWER.

Terminal Block SPEC (Indoor)

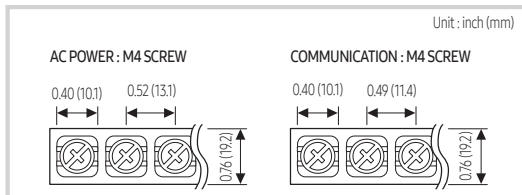

Tightening Torque		
M4	1.2 ~ 1.8 (N•m)	0.87-1.30 (lbf•ft)



Single circuit line wiring connections

⚠ CAUTION

- If an accessory heat kit is installed, power must enter the unit on the top of the top-left side of the unit as shown below (A).

- 1 Before wiring work, you must turn off all power sources.
- 2 Only copper power cables should be used.
- 3 Remove the blower and control box access panel (door).
- 4 Install the cable connectors on the 7/8" (22.2 mm) diameter holes on the right side of the control box.
- 5 Insert the wires through the holes in the casing and through the cable connectors.
- 6 Connect the black supply wire to the L1[1(L)] high voltage connection terminal with compressed ring terminals.
- 7 Connect the white supply wire to the L2[2(N)] high voltage connection terminal with compressed ring terminals.
- 8 Connect the green wire to the ground lug near the supply wire connections with a compressed ring terminal and tighten the ground screw. Make sure to leave extra slack in the ground wire to allow service to the unit without disconnecting the ground wire.

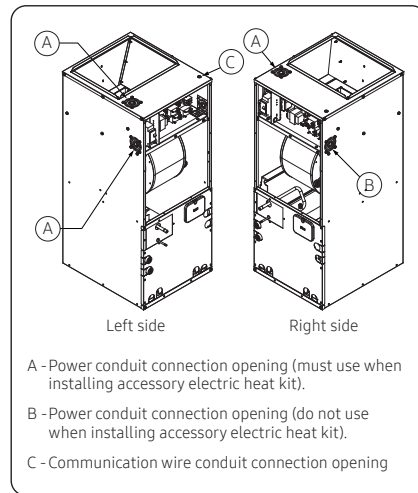

IMPORTANT - All insulation on field wiring must be rated at 140°F (60°C) or higher. Please refer to the wiring diagrams on the air handler or the tables in this manual for more information.

IMPORTANT - Refer to the NEC National Electrical Code (NFPA 70) or the Canadian Electrical Code, Part I (CSA C22.1) and local codes for wiring material requirements.

Power supply wiring with accessory electric heat kit

- 1 Before wiring work, you must turn off all power sources.
- 2 Only copper power cables should be used.
- 3 Remove the blower and control box access panel (door).
- 4 Install the cable connectors on the 7/8" (22.2 mm) diameter holes on the left side of the control box.
- 5 Connect the included power pigtail leads with ring connectors (included with heat kit) to 1(L) and 2(N) terminals located on the right side of the control box.
- 6 Route the power pigtail leads through the control box opening pictured below and route to the left side of the control box for connection to the heat breakers in a later step.

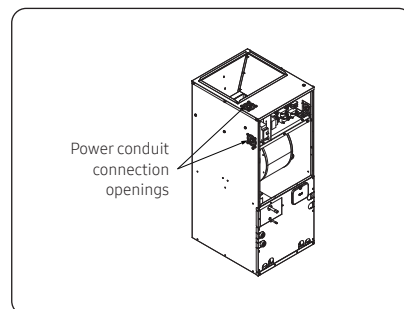



Wiring Work

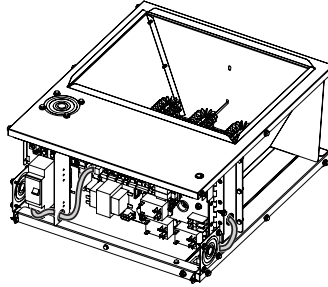

- 7 Swing the hinged control plate outward exposing the back side of the control box. Remove the screws holding the electric heat kit block off the plate. Save the screws.
- 8 Carefully pass the accessory heating element through the rectangular opening in the discharge of the air handler and secure the heating element with the screws from step 8. The heating element support rod must be seated in the hole on the opposite side of the discharge.

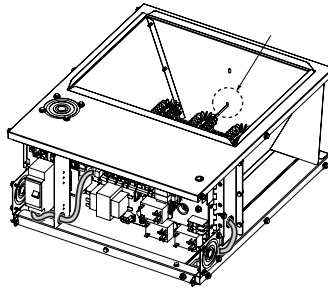

- 9 Install the breakers at the front-left of the control box.
- 10 Connect the power pigtail leads that are connected to 1(L) and 2(N) to the bottom of the breakers.
- 11 Insert the power wires through the holes in the casing and the cable connectors.
- 12 To use the heating function, you need change the installation option code. Set SEG10 to 1. For more information on changing the option code, refer to "Setting an indoor unit installation option".
- 13 Strip ½" (12.7 mm) of the insulation on the end of each power wire.
- 14 Connect the black supply wire to the high voltage connection lug on the accessory heat kit breaker.
- 15 Connect the white supply wire to the other high voltage connection lug on the accessory heat kit breaker.





- 16 Connect the green (ground) wire to the ground lug to the left of the accessory heat kit breakers and tighten the ground lug screw. Make sure to leave extra slack in the ground wire to allow service to the unit without disconnecting the ground wire. If the heat kit requires 2 circuits (dual circuit), both circuit ground wires must be connected to a ground lug (dual circuit kits have two individual ground lugs).

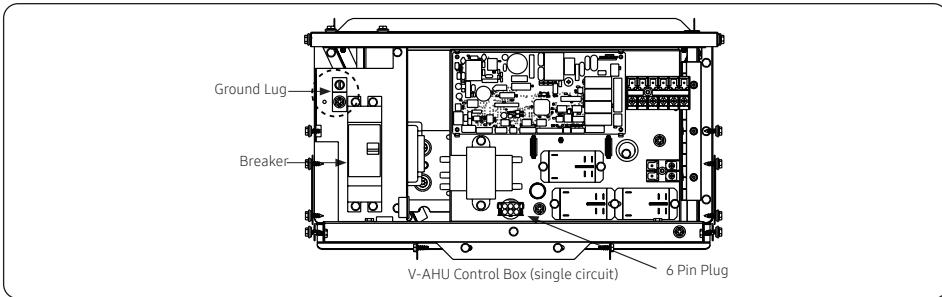

- 17 Connect the six pin male plug on the electric heater assembly to the six pin female plug mounted at the bottom of the control assembly door.
- 18 Remove the wiring diagram from the accessory heat kit. Remove the paper that covers the adhesive back and place the electric heat wiring diagram over the wiring diagram located on the blower housing.

 **NOTE**

- The electric heat kits are equipped with either one or two circuit breakers. These circuit breakers protect the wiring inside of the AHU in the event of a short circuit. Additionally, these breakers provide a means of disconnecting the power to the unit. The circuit breakers in the AHUs are not meant to protect the branch circuit wiring between the furnace and the building's breaker panel. If a sheathed cable is used, refer to the NEC National Electrical Code (NFPA 70) or the Canadian Electrical Code, Part I (CSA C22.1) and local codes for additional requirements concerning supply circuit wiring. Electrical data can be found on page 28.

IMPORTANT - All installation on field wiring must be rated at 140°F (60°C) or higher. Please refer to the wiring diagrams on the furnace or the tables this manual for more information. The 15kW and 20kW models may be connected to a single or dual branch circuit. Refer to the NEC National Electrical Code (NFPA 70) or the Canadian Electrical Code, Part I (CSA C22.1) and local codes for wiring material requirements.



Wiring Work

Power supply connections

If the air handler has been installed before installing the electric heaters or if an older unit is being replaced, the supply power wires must be checked to make sure the wires are the proper sizes to handle the current load for the heaters. Refer to the table below for the correct wire size. If the supply power wire size is incorrect, new wires will need to be installed. Follow the instructions "Power supply wiring" on page 23 of these instructions for proper installation.

ELECTRICAL DATA											
Indoor Unit Models	Volts 1 Ph	Motor Type	Motor HP	208V Motor		Electric Heater Data					
				Amps (FLA)	Amps (FLA)	Field Installed Kit Model Number	No Circuits	kW (208 V)	kW (230 V)	AMPS (208 V)	AMPS (230 V)
SMALL CABINET											
AJ012DNZDCG	208/230	Endura Pro	1/3	0.59	0.65	VHK-103C	1	2.25	2.76	10.83	11.98
AJ018DNZDCG	208/230	Endura Pro	1/3	1.16	1.28	VHK-103C	1	2.25	2.76	10.83	11.98
						VHK-105C	1	3.76	4.59	18.06	19.97
AJ024DNZDCG	208/230	Endura Pro	1/3	1.70	1.88	VHK-103C	1	2.25	2.76	10.83	11.98
						VHK-105C	1	3.76	4.59	18.06	19.97

ELECTRICAL DATA						
Indoor Unit Models	MCA (Minimum Circuit Ampacity)		MOP (Maximum Overcurrent Protection)		Short-Circuit Current Rating	
	MCA 208V (AMPS)	MCA 230V (AMPS)	MOP 208V (AMPS)	MOP 230V (AMPS)	"SCCR"	
					kA rms symmetrical	V maximum
SMALL CABINET						
AJ012DNZDCG	14.27	15.78	15	20	N/A	N/A
AJ018DNZDCG	14.99	16.58	15	20	N/A	N/A
	24.02	26.56	25	30		
AJ024DNZDCG	15.66	17.32	20	20	N/A	N/A
	24.69	27.30	25	30		

- 1 Rated Motor Amps (at DOE External Static Rating Point)
- 2 Fuse or HACR Breaker
- 3 Maximum Overcurrent Device, Overcurrent Protection Installed On Breaker Models Are Sized Per MCA
 - To prevent damage, carefully insert the electric heating assembly through the rectangular opening in front of the discharge opening so the heat element support rod is seated into the hole on the back side of the discharge opening.
 - After installing the electric heater, a one (1) inch (25.4mm) clearance must be maintained on all sides of the supply air duct and/or plenum for a minimum of thirty six (36) inches (914.4mm) from the air handler discharge opening.



Communication wiring connections

- Communication wires connect through the side of the air handler.
- Use an approved connector at the cabinet of the unit to prevent pulling or shorting of control wires.

CAUTION

- Control wire must be rated for 600V minimum.
 - Control wire insulation must be rated for temperatures up to 194°F (90°C).
- 1 Insert the wires through the holes of the right side on the top casing and through the cable connectors.
 - 2 Connect the communication wires to the F1/F2 connection terminal with compressed ring terminals.
 - 3 Connect F3 and F4 (for communication) when installing the wired remote control.

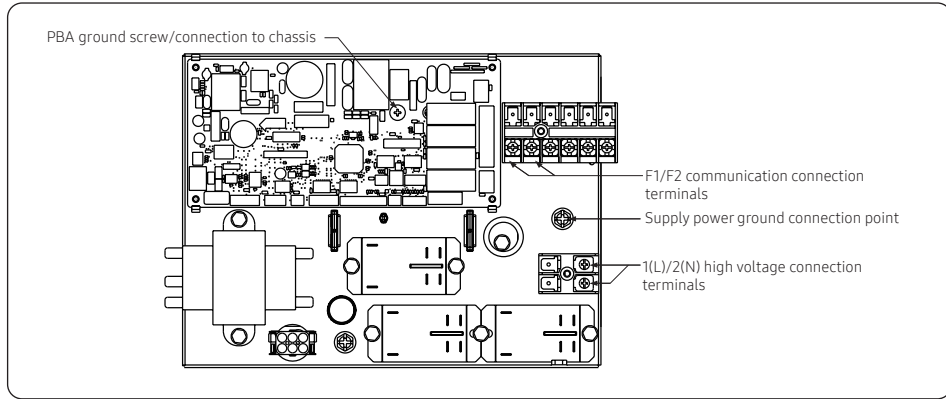

Selecting compressed ring terminal

Nominal dimensions for cable [inch ² (mm ²)]	Nominal dimensions for screw [inch(mm)]	B		D		d1		E Min. [inch(mm)]	F Min. [inch(mm)]	L Max. [inch(mm)]	d2		t Min. [inch(mm)]
		Standard dimension [inch(mm)]	Allowance [inch(mm)]	Standard dimension [inch(mm)]	Allowance [inch(mm)]	Standard dimension [inch(mm)]	Allowance [inch(mm)]				Standard dimension [inch(mm)]	Allowance [inch(mm)]	
0.0023 (1.5)	0.16(4)	0.26(6.6)	±0.0079 (+0.2)	0.13(3.4)	+0.012(+0.3) -0.0079 (-0.2)	0.067(1.7)	±0.0079 (+0.2)	0.16(4.1)	0.24(6.0)	0.63(16.0)	0.17(4.3)	+0.0079 (+0.2) 0(0)	+0.0079 (+0.2) 0(0)
	0.16(4)	0.31(8.0)											
0.0039 (2.5)	0.16(4)	0.26(6.6)	±0.0079 (+0.2)	0.17(4.2)	+0.012(+0.3) -0.0079 (-0.2)	0.091(2.3)	±0.0079 (+0.2)	0.24(6.0)	0.24(6.0)	0.69(17.5)	0.17(4.3)	+0.0079 (+0.2) 0(0)	+0.0079 (+0.2) 0(0)
	0.16(4)	0.33(8.5)											
0.0062 (4.0)	0.16(4.0)	0.37(9.5)	±0.0079 (+0.2)	0.22(5.6)	+0.012(+0.3) -0.0079 (-0.2)	0.134(3.4)	±0.0079 (+0.2)	0.24(6.0)	0.24(6.0)	0.79(20.0)	0.17(4.3)	+0.0079 (+0.2) 0(0)	+0.0079 (+0.2) 0(0)

Installation





Wiring Work

CAUTION

- Select the power cable following relevant local and national regulations.
- Wire size must comply with local and national codes.
- Power supply cords of parts of appliances for outdoor use shall not be lighter than polychloroprene sheathed flexible cord. (Code designation IEC:60245 IEC 57 / CENELEC: H05RN-F or IEC:60245 IEC 66 / CENELEC: H07RN-F)
- You should connect the power cable to the power cable terminal and fasten it with a clamp.
- The unbalanced power must be maintained within 10 % the of supply rating among whole indoor units.
- If the power is unbalanced greatly, it may shorten the life of the condenser. If the unbalanced power exceeds over 10% of the supply rating, the indoor unit is protected, stopped and the error mode indicates.
- To protect the product from water and possible shock, you should keep the power cable and the connection cord of the indoor and outdoor units in the conduit.
- You must keep the cable in a protective conduit.
- Keep distances of 2" (50 mm) or more between the power cable and communication cable.
- The maximum length of power cables is decided within 10% of power drop. If it exceeds, you must consider another power supplying method.
- Use round pressure/crimp terminal for connections to the power terminal block.
- For wiring, use the designated power cable and connect it firmly, then secure it to prevent outside pressure from being exerted on the terminal board.
- Use an appropriate screwdriver for tightening the terminal screws.
- A screwdriver with a small head will strip the head and make proper tightening impossible.
- Over-tightening the terminal screws may break them.
- See the table below for tightening torque for the terminal screws.

	Tightening torque	
	N•m	lb•ft
M3.5	0.8-1.2	0.58-0.87
M4	1.2-1.8	0.87-1.30

- When installing the indoor unit in a computer room or network room, use the double shielded communication cable (tape aluminum / polyester braid + copper) of FROHH2R or LiYCY type.

Wire Diagram

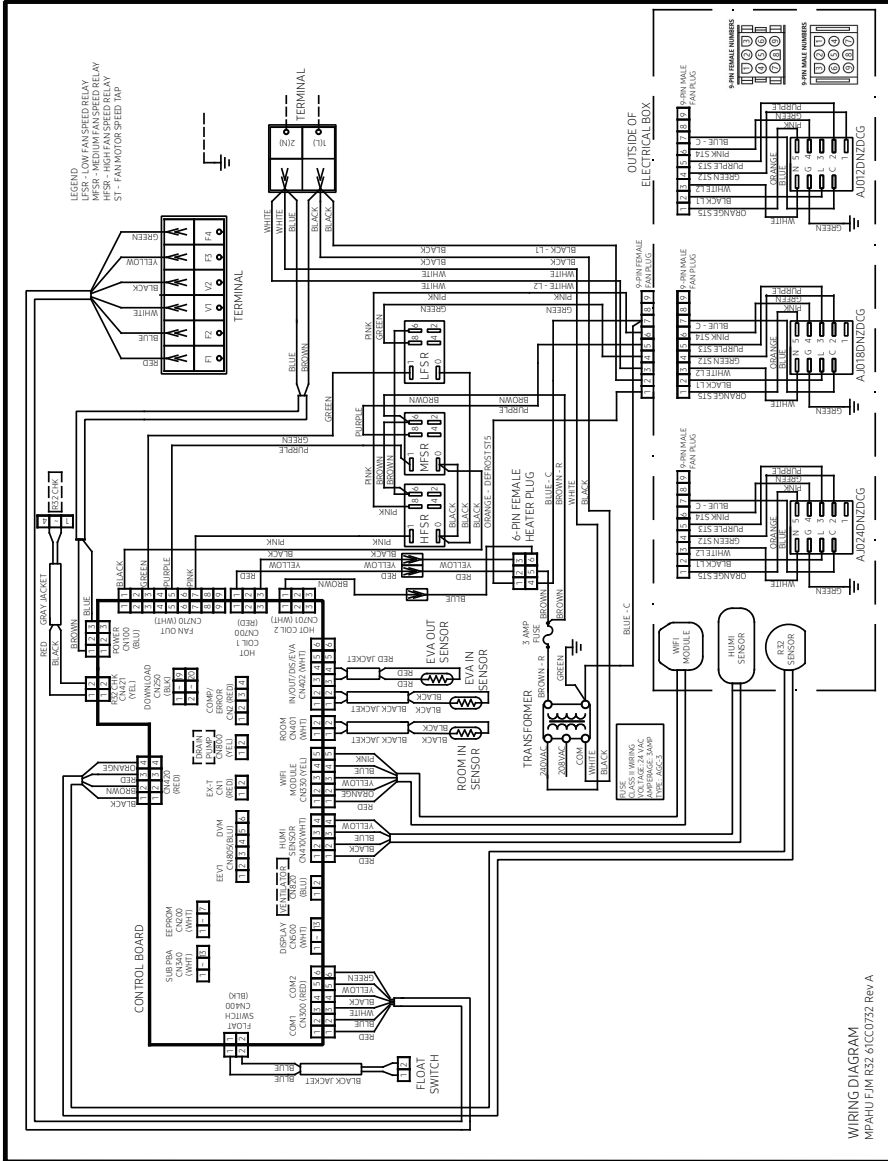

Installation

Selecting motor speed

Selecting the Constant Torque Blower Speed

This air handler uses a Constant Torque high efficiency motor. This motor operates on 240 VAC. The motor speed taps are 24 VAC, 0.03 amps, 60 Hz, and 1 PH. The speed taps can be adjusted according to installation needs. Table 4 shows the motor lead connection labeling and the connection definitions. See blower tables in the later section for airflow data.

A total of 24 VAC circuit amps are 0.14 amps.

Change Motor Speeds

- 1 Turn off all electrical supply circuits to the air handler at the main service (House Circuit Breaker) panel.
- 2 Remove the blower door and switch the air handler circuit breaker(s) to "OFF".
- 3 Disconnect the wire from the isolation relay terminal and reconnect the desired wire to the terminal. The RED wire is high speed. The VIOLET wire is mid speed. The GREEN wire is low speed. The ORANGE wire is electric heat with high fan speed. The ORANGE wire must be connected to a speed tap that will provide sufficient airflow for the size of the electric heat kit. Refer to the heat kit installation manuals for minimum CFM for electric heat kit activation.
- 4 Turn the circuit breakers on and reinstall the air handler blower door.
- 5 Turn on all electrical supply circuits to the air handler at the main service (House Circuit Breaker) panel.
- 6 When black wire(Standard) is required to be connected to tap 5, the orange wire that originally connected to tap 5 can be connected to any tap except tap 5.

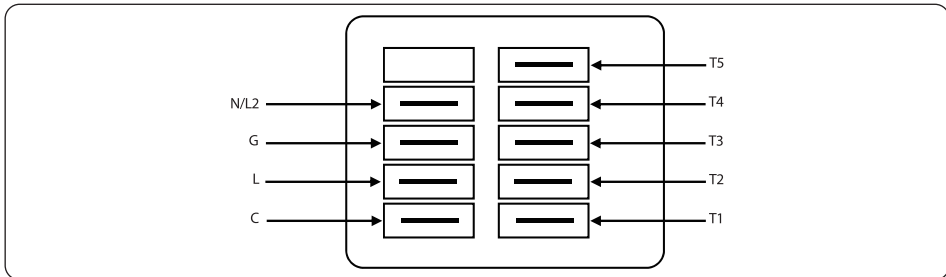

Terminal	Connection	Default speed tap settings		
		AJ012DNZDCG	AJ018DNZDCG	AJ024DNZDCG
C	Speed tap common - 24 VAC common			
L	Supply voltage - 240 VAC Line 1			
G	Ground connection			
N/L2	Supply voltage - 240 VAC Line 2			
T1	Low speed tap - 24 VAC input	"Low" speed		
T2	Medium-low speed tap - 24 VAC input	"Mid" speed	"Low" speed	"Low" speed
T3	Medium speed tap - 24 VAC input		"Mid" speed	"Mid" speed
T4	Medium-high speed tap - 24 VAC input	"High" speed	"High" speed	"High" speed
T5	High speed tap - 24 VAC input	High speed for electric heat	High speed for electric heat	High speed for electric heat

Motor control/voltage taps



Blower CFM tables

AJ012DNZDCG

HP: 1/3 Default motor taps : High/Mid/Low = 4/2/1.

Motor Tap	P(inwg)	CFM	Motor Tap	P(inwg)	CFM
1	0.1	502	4	0.1	523
	0.2	376		0.2	449
	0.25	346		0.25	426
	0.3	320		0.3	400
	0.4	241		0.4	373
	0.5	179		0.5	302
2	0.1	512	5	0.1	545
	0.2	399		0.2	496
	0.25	374		0.25	492
	0.3	346		0.3	475
	0.4	280		0.4	423
	0.5	234		0.5	382
3	0.1	519			
	0.2	426			
	0.25	399			
	0.3	374			
	0.4	320			
	0.5	269			

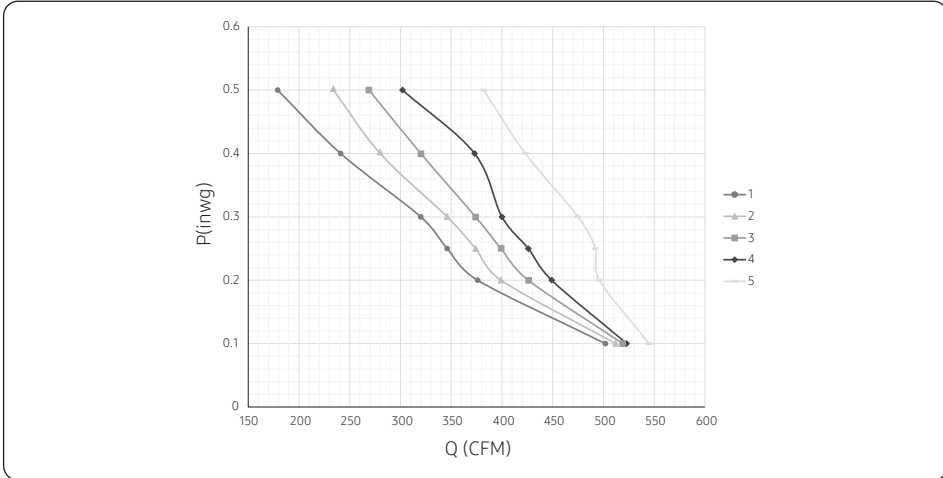

Installation





Blower CFM tables

AJ018DNZDCG

HP: 1/3 Default motor taps : High/Mid/Low = 4/3/2.

Motor Tap	P(inwg)	CFM	Motor Tap	P(inwg)	CFM
1	0.1	543	4	0.1	700
	0.2	512		0.2	681
	0.3	479		0.3	660
	0.4	446		0.4	638
	0.5	411		0.5	615
	0.6	374		0.6	591
	0.7	337		0.7	566
	0.8	298		0.8	540
2	0.1	583	5	0.1	742
	0.2	562		0.2	722
	0.3	538		0.3	702
	0.4	511		0.4	681
	0.5	481		0.5	658
	0.6	448		0.6	635
	0.7	413		0.7	612
	0.8	375		0.8	587
3	0.1	638			
	0.2	618			
	0.3	595			
	0.4	571			
	0.5	544			
	0.6	515			
	0.7	483			
	0.8	449			

Installation

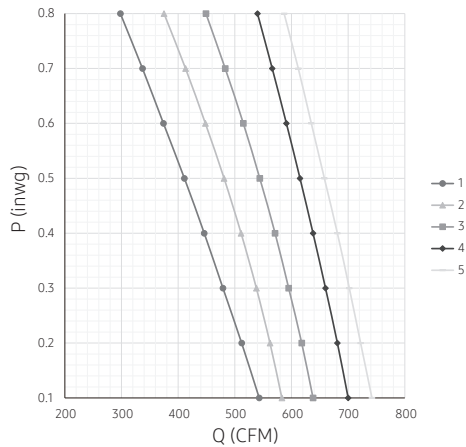



AJ024DNZDCG

HP: 1/3 Default motor taps : High/Mid/Low = 4/3/2.

Motor Tap	P(inwg)	CFM	Motor Tap	P(inwg)	CFM
1	0.1	543	4	0.1	811
	0.2	512		0.2	810
	0.3	479		0.3	797
	0.4	446		0.4	773
	0.5	411		0.5	737
	0.6	374		0.6	689
	0.7	337		0.7	630
	0.8	298		0.8	559
2	0.1	564	5	0.1	894
	0.2	542		0.2	890
	0.3	518		0.3	870
	0.4	492		0.4	837
	0.5	464		0.5	789
	0.6	433		0.6	726
	0.7	400		0.7	649
	0.8	366		0.8	558
3	0.1	669			
	0.2	649			
	0.3	628			
	0.4	606			
	0.5	582			
	0.6	559			
	0.7	534			
	0.8	508			

Installation

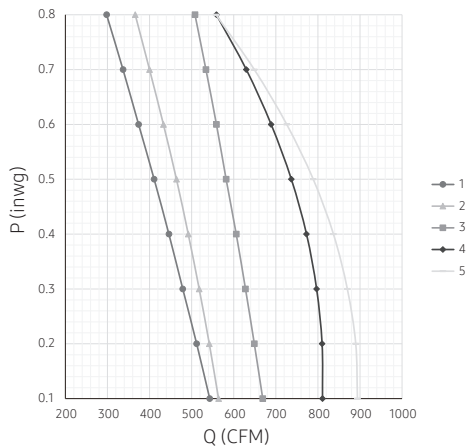



Connecting External Float switch

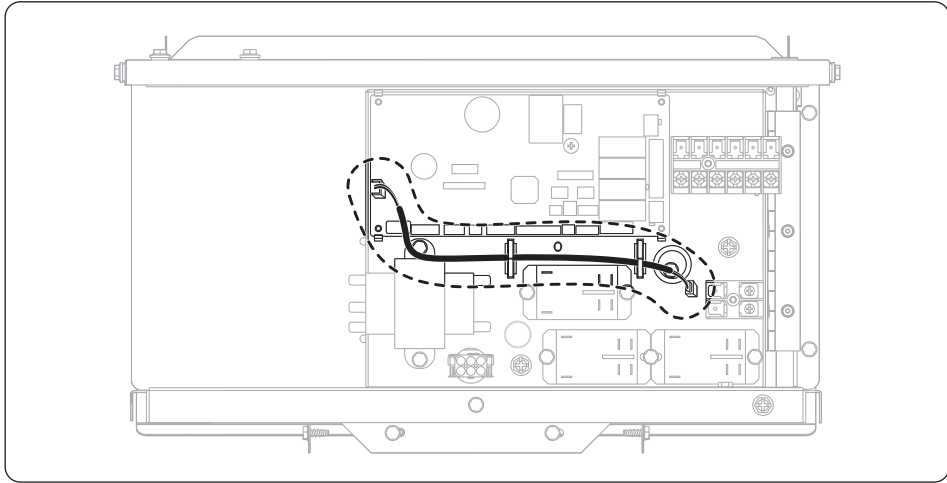

- 1 Connect the external float switch to the 2PIN wire (BLK).
- 2 If the connector types of the external float switch and 2PIN wire do not match, cut off the end of the 2PIN wire before connecting the wire to the external float switch.
- 3 Set SEG8 for the install option (Refer to "Setting an indoor unit installation option")

NOTE

- The External Floating switch is not sold separately by Samsung.



Installing external outputs

- An external output signal occurs if the R-32 sensor in the indoor unit detects a refrigerant leak, or the sensor has a malfunction or short circuit.
- Based on this signal, safety measures required for the indoor unit, such as ventilation system activation and alarm activation, can be taken.
- MIM-B14U (External Contact Control Module) can be used to link the GAS LEAK output.

For controlling AC LAMP (On/Off)

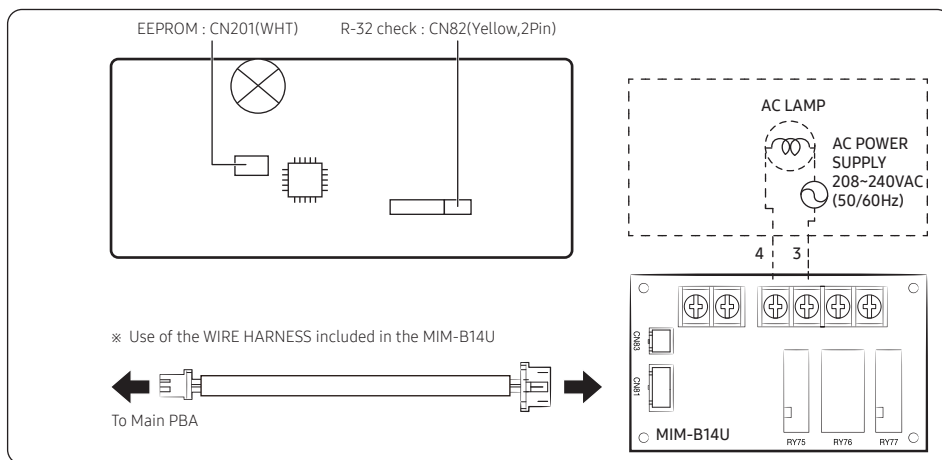

For controlling EXTERNAL ALARM (On/Off)

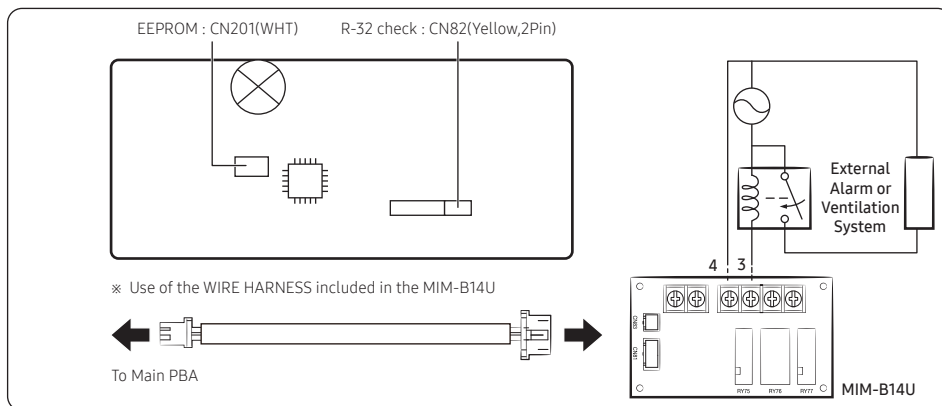





NOTE

- The MIM-B14U can be connected to the required load on connectors 3 and 4.
- The load is AC (208-230), AC 2.25Amax
- When an error occurs due to a gas leak or R-32 sensor error, 3 and 4 are in a short state (the relay operates).

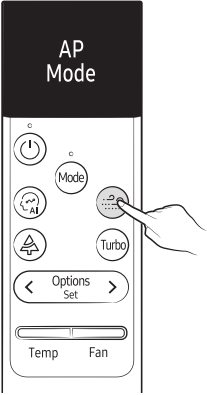
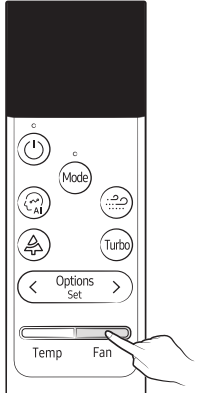
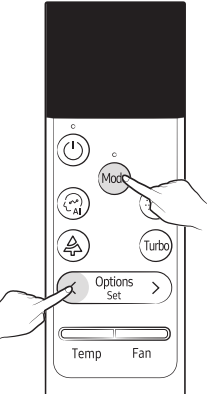

Optional : LED Display indicator specifications when checking Wi-Fi Easy Setup and Wi-Fi status

The wireless remote control can be used for Easy Setup, checking the internet connection status and connecting or disconnecting Wi-Fi.

Easy Setup	Check internet connection status	Enable/Disable Wi-Fi
		
<p>Press the  button for 5 seconds</p>	<p>Press the  button for 5 seconds</p>	<p>Press the  and  button for 5 seconds</p>

Installation



Setting the indoor unit addresses and the installation options

Setting the indoor unit addresses and the installation options with wireless remote controller

You cannot set both of the indoor unit addresses and the installation options in a batch: set both of them respectively. Receiver & display unit must be connected to the indoor unit to set options with the wireless remote control.

- d Make sure that you are entered to the mode for setting options.

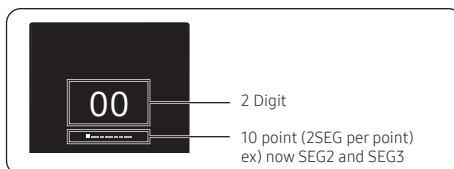

Common steps for setting the addresses and options

Remote controls

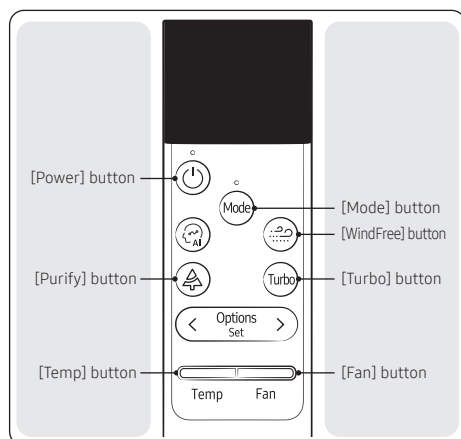

NOTE

- The remote control display and buttons may vary depending on the model.

1 Enter the mode for setting the options.

- Reset remote control: button Down + button Down + Press for 10 seconds
- You can see the "SW Initialization" message and enter the following in 5 seconds.
- Press button and button for 5 seconds.

2 Set the option values.

CAUTION

- The total number of available options are 24 : SEG1 to SEG24
- Because SEG1, SEG7, SEG13 and SEG19 are the page options used by the previous remote control models, the modes to set values for these options are skipped automatically.
- Set a 2-digit value for each option pair in the following order.
- You can see 20 SEG (except SEG1, SEG7, SEG13, SEG19) SEG2 → ... → SEG6 → SEG8 → ... → SEG12 → SEG14 → ... → SEG18 → SEG20 → ... → SEG24

























SEG1	SEG2	SEG3	SEG4	SEG5	SEG6
0	X	X	X	X	X
SEG7	SEG8	SEG9	SEG10	SEG11	SEG12
1	X	X	X	X	X
SEG13	SEG14	SEG15	SEG16	SEG17	SEG18
2	X	X	X	X	X
SEG19	SEG20	SEG21	SEG22	SEG23	SEG24
3	X	X	X	X	X

- You can set the next SEG by pressing the button.
- You can change the digit value through the following operation.
Left value: up or down, range : 0 ~ F
Right value: up or down, range : 0 ~ F





















Setting the indoor unit addresses and the installation options

Take the steps presented in the following table:

Steps	Remote control display
<p>1 Set the SEG2 and SEG3 values:</p> <p>a Set the SEG2 value by pressing the  button repeatedly until the value you want to set appears on the remote control display.</p> <p>b Set the SEG3 value by pressing the  button repeatedly until the value you want to set appears on the remote control display.</p> <p>When you press the  or  button, values appear in the following order:  →  → ... →  → </p>	 SEG2  SEG3
<p>2 Press the  button to move to the next page.</p>	
<p>3 Set the SEG4 and SEG5 values:</p> <p>a Set the SEG4 value by pressing the  button repeatedly until the value you want to set appears on the remote control display.</p> <p>b Set the SEG5 value by pressing the  button repeatedly until the value you want to set appears on the remote control display.</p> <p>When you press the  or  button, values appear in the following order:  →  → ... →  → </p>	 SEG4  SEG5
<p>4 Press the  button to move to the next page.</p>	























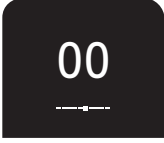



Steps	Remote control display
<p>5 Set the SEG6 and SEG8 values:</p> <p>a Set the SEG6 value by pressing the  button repeatedly until the value you want to set appears on the remote control display.</p> <p>b Set the SEG8 value by pressing the  button repeatedly until the value you want to set appears on the remote control display.</p> <p>When you press the  or  button, values appear in the following order: </p>	 SEG6  SEG8
<p>6 Press the  button to move to the next page.</p>	
<p>7 Set the SEG9 and SEG10 values:</p> <p>a Set the SEG9 value by pressing the  button repeatedly until the value you want to set appears on the remote control display.</p> <p>b Set the SEG10 value by pressing the  button repeatedly until the value you want to set appears on the remote control display.</p> <p>When you press the  or  button, values appear in the following order: </p>	 SEG9  SEG10
<p>8 Press the  button to move to the next page.</p>	

















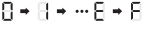



Setting the indoor unit addresses and the installation options

Steps	Remote control display
<p>9 Set the SEG11 and SEG12 values:</p> <p>a Set the SEG11 value by pressing the  button repeatedly until the value you want to set appears on the remote control display.</p> <p>b Set the SEG12 value by pressing the  button repeatedly until the value you want to set appears on the remote control display.</p> <p>When you press the  or  button, values appear in the following order:  →  → ... →  → </p>	 <p>SEG11</p>  <p>SEG12</p>
<p>10 Press the  button to move to the next page.</p>	
<p>11 Set the SEG14 and SEG15 values:</p> <p>a Set the SEG14 value by pressing the  button repeatedly until the value you want to set appears on the remote control display.</p> <p>b Set the SEG15 value by pressing the  button repeatedly until the value you want to set appears on the remote control display.</p> <p>When you press the  or  button, values appear in the following order:  →  → ... →  → </p>	 <p>SEG14</p>  <p>SEG15</p>
<p>12 Press the  button to move to the next page.</p>	

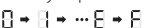

























Steps	Remote control display
<p>13 Set the SEG16 and SEG17 values:</p> <p>a Set the SEG16 value by pressing the  button repeatedly until the value you want to set appears on the remote control display.</p> <p>b Set the SEG17 value by pressing the  button repeatedly until the value you want to set appears on the remote control display.</p> <p>When you press the  or  button, values appear in the following order: </p>	 <p>SEG16</p>  <p>SEG17</p>
<p>14 Press the  button to move to the next page.</p>	
<p>15 Set the SEG18 and SEG20 values:</p> <p>a Set the SEG18 value by pressing the  button repeatedly until the value you want to set appears on the remote control display.</p> <p>b Set the SEG20 value by pressing the  button repeatedly until the value you want to set appears on the remote control display.</p> <p>When you press the  or  button, values appear in the following order: </p>	 <p>SEG18</p>  <p>SEG20</p>
<p>16 Press the  button to move to the next page.</p>	





Setting the indoor unit addresses and the installation options

Steps	Remote control display
<p>17 Set the SEG21 and SEG22 values:</p> <p>a Set the SEG21 value by pressing the  button repeatedly until the value you want to set appears on the remote control display.</p> <p>b Set the SEG22 value by pressing the  button repeatedly until the value you want to set appears on the remote control display.</p> <p>When you press the  or  button, values appear in the following order:  →  → ...  → </p>	 <p>SEG21</p>  <p>SEG22</p>
<p>18 Press the  button to move to the next page.</p>	
<p>19 Set the SEG23 and SEG24 values:</p> <p>a Set the SEG23 value by pressing the  button repeatedly until the value you want to set appears on the remote control display.</p> <p>b Set the SEG24 value by pressing the  button repeatedly until the value you want to set appears on the remote control display.</p> <p>When you press the  or  button, values appear in the following order:  →  → ...  → </p>	 <p>SEG23</p>  <p>SEG24</p>





- 3 Check whether the option values you have set are correct by pressing the button repeatedly.



EX) AJ***DNZDCG

020410-100000-200020-300000

- 4 Save the option values into the indoor unit:
Point the remote control to the remote control sensor on the indoor unit and then press the button on the remote control twice.
Make sure that this command is received by the indoor unit. When it is successfully received, you can hear a short sound from the indoor unit. If the command is not received, press the button again.
- 5 Check whether the air conditioner operates following the option values you have set:
- a Reset the indoor or outdoor unit.
- Indoor Unit : Press button + button for 5 seconds
 - Outdoor Unit : Press the K3 button

- b Reset remote control: button Down + button Down + Press for 10 seconds
You can see the "SW Initialization" message.

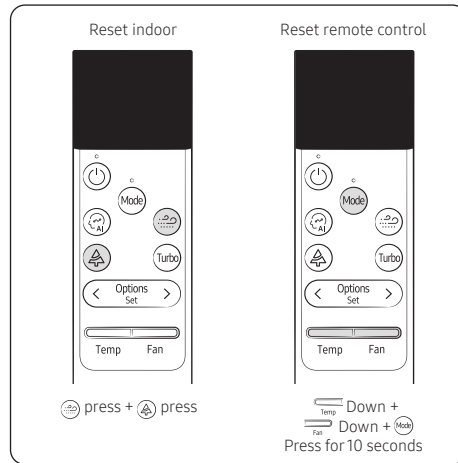

Installation



Setting the indoor unit addresses and the installation options

Setting the indoor unit option code with the wired remote control

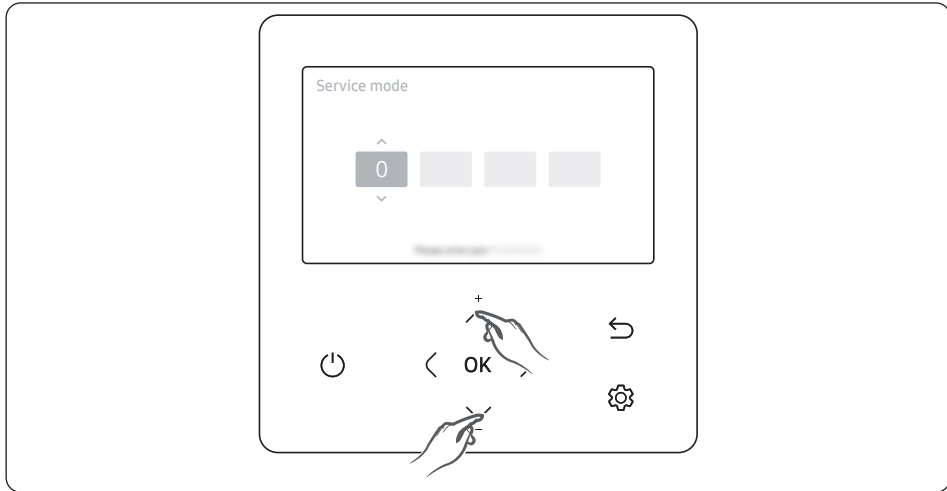

- 1 If you want to use the various additional functions for your Wired Remote Control, press the \wedge and \vee buttons at the same time for more than 3 seconds.
 - The password entry screen appears.
- 2 Enter the password, "0202," and then press the **OK** button.
 - The settings screen for installation mode/Service mode appears.
- 3 See the list of additional functions for the Wired Remote Control on the next page, and then select the Product option menu.
 - Once you have entered the settings screen, the current setting appears.
 - Refer to the chart for data setting.
 - Using the \wedge / \vee buttons, change the settings and press the \rangle button to move to the next setting.
 - Press the **OK** button to save the new setting.
 - Press the \hookrightarrow button to move to the Home screen.

NOTE

- While setting the data, you can press the \hookrightarrow button to move to the Home screen after checking the saving status at a pop-up screen.
- While setting the data, you can press the \hookrightarrow button to move to the Home screen after checking the saving status at a pop-up screen.



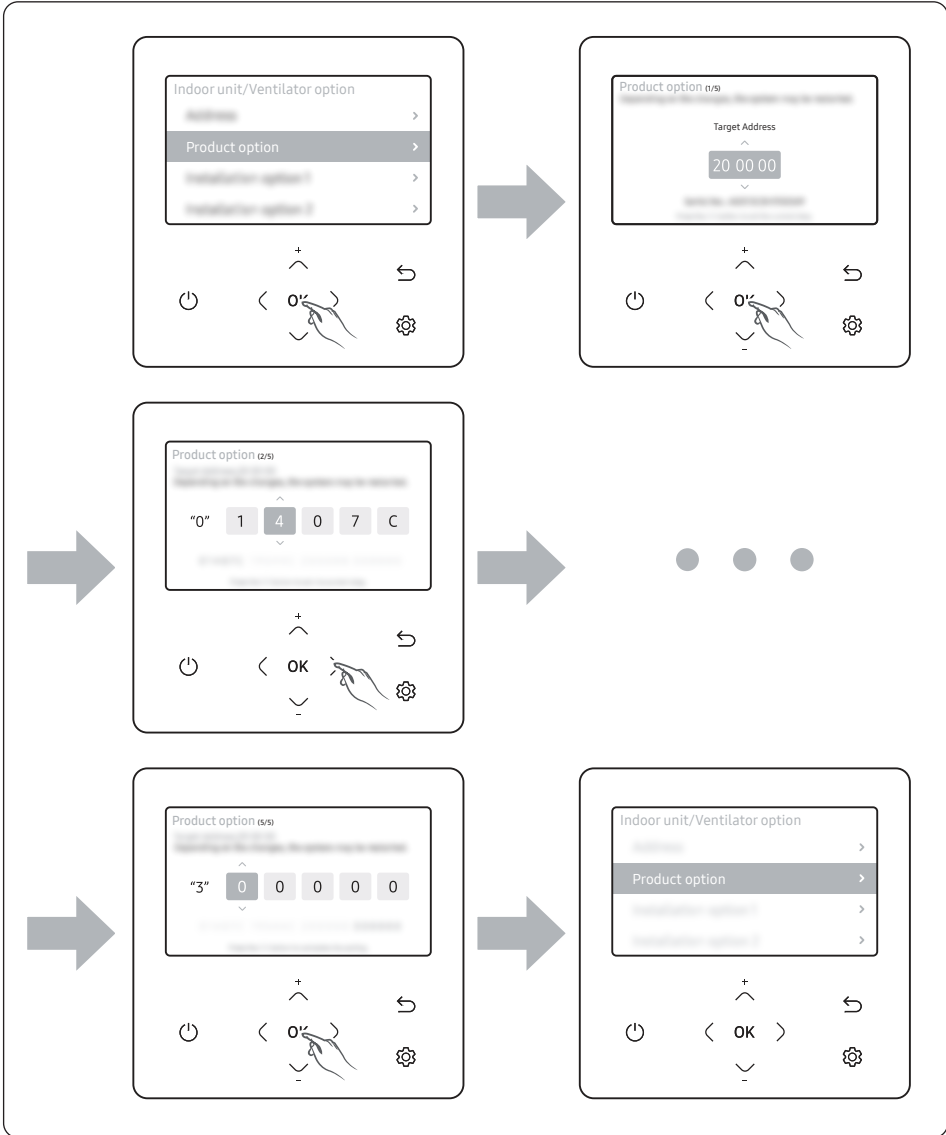

Installation





Setting the indoor unit addresses and the installation options

[Product Option 1page]

Product Option (1/5)

Target Address

20 00 01

Press the OK button to set the current step.

[Product Option 2page]

Product Option (2/5)

Target Address: 20 00 01

"0" 1 0 0 0 0

Press the OK button to set the current step.

[Product Option 3page]

Product Option (3/5)

Target Address: 20 00 01

"1" 0 0 0 0 0

Press the OK button to set the current step.

[Product Option 4page]

Product Option (4/5)

Target Address: 20 00 01

"2" 0 0 0 0 0

Press the OK button to set the current step.

[Product Option 5page]

Product Option (5/5)

Target Address: 20 00 01

"3" 0 0 0 0 0

Press the OK button to set the current step.

Installation



SEG1	SEG2	SEG3	SEG4	SEG5	SEG6
0	*	*	*	*	*

Page number

SEG7	SEG8	SEG9	SEG10	SEG11	SEG12
1	*	*	*	*	*

Page number

SEG13	SEG14	SEG15	SEG16	SEG17	SEG18
2	*	*	*	*	*

Page number

SEG19	SEG20	SEG21	SEG22	SEG23	SEG24
3	*	*	*	*	*

Page number

CAUTION

- Option code will not be applied if you don't press the **OK** button.
- Setting the indoor unit option code is only possible in the Main wired remote Control. You can only check the indoor unit option code in Sub wired remote Control.
- Setting an indoor unit option code is possible when one indoor unit is connected. If more than 2 indoor units are connected, you can only check the Main indoor unit option code.





Setting the indoor unit addresses and the installation options

Setting indoor unit addresses and installation options with wired remote control

Set the indoor unit address and installation option with the remote control option. Set each option separately since you cannot set the ADDRESS setting and indoor unit installation setting option at the same time. You need to set twice when setting the indoor unit address and installation option.

Setting an indoor unit address

- 1 If you want to use the various additional functions for your Wired Remote control, press the \wedge and \vee buttons at the same time for more than 3 seconds.
 - The password entry screen appears.
- 2 Enter the password, "0202," and then press the **OK** button.
 - The settings screen for installation mode/Service mode appears.
- 3 See the list of additional functions for the Wired Remote control on the next page, and then select the Address menu.
 - Once you have entered the settings screen, the current setting appears.
 - Refer to the chart for data setting.
 - Using the \wedge / \vee buttons, change the settings and press the \rangle button to move to the next setting.
 - Press the **OK** button to save the new setting.
 - Press the \hookrightarrow button to move to the Home screen.



NOTE

- While setting the data, you can press the \hookrightarrow button to move to the Home screen after checking the saving status at a pop-up screen.

Indoor Unit/Ventilator Option

Address	>
Product Option	>
Installation Option 1	>
Installation Option 2	>

1	Address - Move to 'Address' page.
2	Product Option - Move to 'Product option' page.
3	Installation Option 1 - Move to 'Installation option 1' page.
4	Installation Option 2 - Move to 'Installation option 2' page.





[Address > Main Address]		[Address > RMC Address]	
Main Address		RMC Address	
Target Address	New address	Target Address	New address
^ <div style="border: 1px solid black; padding: 2px; display: inline-block;">20 00 01</div> v	<div style="border: 1px solid black; padding: 2px; display: inline-block;">0</div> <div style="border: 1px solid black; padding: 2px; display: inline-block;">8</div>	^ <div style="border: 1px solid black; padding: 2px; display: inline-block;">20 00 01</div> v	<div style="border: 1px solid black; padding: 2px; display: inline-block;">0</div> <div style="border: 1px solid black; padding: 2px; display: inline-block;">8</div>
Address setting range : Main (0 ~ 4F) / RMC (0 ~ FE)			

NOTE

- Press the button anytime during setup to exit without setting.
- Address will not be applied if you don't press **OK** button.
- Setting the Main/RMC Address of an Indoor unit is available only with a Main wired remote control.

Setting an indoor unit installation option

- 1 If you want to use the various additional functions for your Wired Remote control, press the and buttons at the same time for more than 3 seconds.
 - The password entry screen appears.
- 2 Enter the password, "0202," and then press the **OK** button.
 - The settings screen for installation mode/Service mode appears.
- 3 See the list of additional functions for the Wired Remote control on the next page, and then select the Installation Option 1 menu.
 - Once you have entered the settings screen, the current setting appears.
 - Refer to the chart for data setting.
 - Using the / buttons, change the settings and press the button to move to the next setting.
 - Press the **OK** button to save the new setting.
 - Press the button to move to the Home screen.

NOTE

- While setting the data, you can press the button to move to the Home screen after checking the saving status at a pop-up screen.





Setting the indoor unit addresses and the installation options

[Installation Option 1-1page]

Installation Option 1 (1/5)

Target Address

^

20 00 01

∨

Please refer to the manual.

Please the OK button to set the current step.

[Installation Option 1-2page]

Installation Option 1 (2/5)

Target Address: 20 00 01

Setting the indoor unit address

"0" 2 **0** 0 0 0

^

∨

Please refer to the manual.

Please the OK button to set the current step.

[Installation Option 1-3page]

Installation Option 1 (3/5)

Target Address: 20 00 01

Setting the indoor unit address

"1" **0** 0 0 0 0

^

∨

Please refer to the manual.

Please the OK button to set the current step.

[Installation Option 1-4page]

Installation Option 1 (4/5)

Target Address: 20 00 01

Setting the indoor unit address

"2" **0** 0 0 0 0

^

∨

Please refer to the manual.

Please the OK button to set the current step.

[Installation Option 1-5page]

Installation Option 1 (5/5)

Target Address: 20 00 01

Setting the indoor unit address

"3" **0** 0 0 0 0

^

∨

Please refer to the manual.

Please the OK button to set the current step.

Installation





SEG1	SEG2	SEG3	SEG4	SEG5	SEG6
0	2	RESERVED	External room temperature sensor /Minimizing fan operation when the thermostat is off	Central control	RESERVED
SEG7	SEG8	SEG9	SEG10	SEG11	SEG12
1	Drain pump & Emergency Stop	Hot Coil	Auxiliary heater	Controller variables for the auxiliary heater	RESERVED
SEG13	SEG14	SEG15	SEG16	SEG17	SEG18
2	External control	External control output	RESERVED	Buzzer	Maximum filter usage time
SEG19	SEG20	SEG21	SEG22	SEG23	SEG24
3	Individual control of a remote control	Heating setting compensation	RESERVED	Away Set OFF Timer	RESERVED

 **NOTE**

- Press  button anytime during setup to exit without setting.
- Option code will not be applied if you don't press **OK** button.
- The setting Installation option code is available only with a Main wired remote control.
- Setting Installation option code is available when there is one-on-one connection between a wired remote control and an indoor unit.



Setting the indoor unit addresses and the installation options

Setting the installation options in a batch

Option No. for an installation options: 0XXXXX-1XXXXX-2XXXXX-3XXXXX

- 1 Make sure that the power is supplied to the indoor unit. If the indoor unit is not plugged in, it must include a power supply.

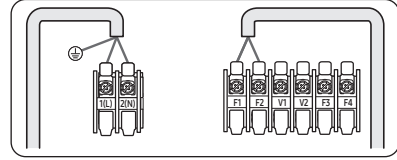

- 2 Set the installation options of indoor units, by referring to the following table and by following the steps in "Common steps for setting the addresses and options" on page 39.

- The installation options of indoor units are set to like a below table by default.

Model	AJ***DNZDCG
O2 series installation option	020410-100000-200020-300000
O5 series installation option	050030-100700-200000-300000

- The SEG20 option, Individual control with remote control, allows you to control multiple indoor units individually by using the remote control.

O2 series installation option (Detailed)

Option No. : 02XXXX-1XXXXX-2XXXXX-3XXXXX

Option	SEG1		SEG2		SEG3	SEG4		
Function	Page		Mode		Reserved	Use of external room temperature sensor / Minimizing fan operation when thermostat is off ¹⁾		
Indication and details	Indication	Details	Indication	Details		Indication	Details	
	0			2				Use of external room temperature sensor
					0	Disuse	Disuse	
					1	Use	Disuse	
					2	Disuse	Use (Heating)	
					3	Use	Use (Heating)	
					4	Disuse	Use (Cooling)	
					5	Use	Use (Cooling)	
					6	Disuse	Use (Cooling/Heating)	
					7	Use	Use (Cooling/Heating)	
					8	Disuse	Use (Cooling Ultra low speed)	
					9	Use	Use (Cooling Ultra low speed)	
					A	Disuse	Use (Heating/Cooling Ultra low speed)	
					B	Use	Use (Heating/Cooling Ultra low speed)	
					C	Disuse	Use user set flow (when Thermostat is off)	
					D	Use	Use user set flow (when Thermostat is off)	





Option	SEG 5		SEG 6	SEG 7		SEG 8			SEG 9	
Function	Central control		Reserved	Page		Use of drain pump			Use of Hot Coil	
Indication and details	Indication	Details		Indication	Details	Indication	Details		Indication	Details
	0	Disuse		1	0 or 4	Disuse	Disuse	Drain pump		
					1 or 5	Use		Use with 3min delay		
			2 or 6		Use with 3min delay					
1	Use	1	3 or 7	Disuse	Use	8 or C	Disuse	1	Use	
			9 or D	Use		A or E	Use with 3min delay			
			A or E	Use with 3min delay		B or F	Disuse			
			Option	SEG 10						SEG 11
Function	Use of Hot auxiliary heater						Controller variables for auxiliary heater			Reserved
	Indication	Details					Indication	Details		
		Heater use	Heater operation setting during defrosting	Emergency heater use	Fan Operation			Set temperature for auxiliary heat on	Time delay for auxiliary heat on	
Indication and details	0	Disuse	OFF	Disuse	OFF	ON	0	No temperature offset	No delay	
	1	USE	OFF	Disuse	OFF	ON	1	No temperature offset	10 minutes	
	2	USE	ON	Disuse	ON	ON	2	No temperature offset	20 minutes	
	3	USE	ON	Disuse	OFF	ON	3	2.7°F (1.5°C)	No delay	
	4	USE	ON	Disuse	ON	OFF	4	2.7°F (1.5°C)	10 minutes	
	5	USE	ON	Use	ON	ON	5	2.7°F (1.5°C)	20 minutes	
	6	USE	ON	Use	OFF	ON	6	5.4°F (3°C)	No delay	
	7	USE	ON	Use	ON	OFF	7	5.4°F (3°C)	10 minutes	
	8	USE	OFF	Disuse	ON	ON	8	5.4°F (3°C)	20 minutes	
	9	USE	OFF	Disuse	OFF	ON	9	8.1°F (4.5°C)	No delay	
A	USE	OFF	Use	ON	ON	A	8.1°F (4.5°C)	10 minutes		
B	USE	OFF	Use	OFF	ON	B	8.1°F (4.5°C)	20 minutes		
						C	10.8°F (6°C)	No delay		
						D	10.8°F (6°C)	10 minutes		
						E	10.8°F (6°C)	20 minutes		

Installation



Setting the indoor unit addresses and the installation options

Option	SEG13		SEG14			SEG15		SEG16	SEG17		SEG18		
Function	Page		Use of external control			Setting the output of external control		Reserved	Buzzer control			Maximum filter usage time ²⁾	
Indication and details	Indication	Details	Indication	Details		Indication	Details		Indication	Details		Indication	Details
				Buzzer	Refrigerant detection sensor								
Indication and details	2	0	Disuse	Sub, Existing control	0	Thermo on	0	Use	Disuse	2	1000 hours		
		1	On/Off		1	Operation on							
		2	Off										
		3	Window On/Off	Main, Existing control	2	External heater use (Fan On when the heater is running) Emergency heater disuse							
		4	Disuse										
		5	On/Off										
		6	Off										
		7	Window On/Off										
		8	Disuse										
		9	On/Off	Sub, Reverse control	4	External heater use (Fan On when the heater is running, Fan off only in case of Defrost) Emergency heater disuse	2	Use	Use	6	2000 hours		
		A	Off										
		B	Window On/Off										
		C	Disuse	Main, Reverse control	6	External heater use (Fan OFF when the heater is running) Emergency heater use	3	Disuse	Use				
D	On/Off												
E	Off												
F	Window On/Off												
Option	SEG19		SEG20			SEG21		SEG22	SEG23		SEG24		
Function	Page		Individual control with remote control ³⁾			Heating setting compensation ⁴⁾		Reserved	Reserved	Reserved			
Indication and details	Indication	Details	Indication	Details		Indication	Details						
				0,1	Indoor1						0	Default	
			2	Indoor2	1	3.6°F (2°C)							
			3	Indoor3									
			4	Indoor4	2	9°F (5°C)							

- ¹⁾ SEG4
By the SEG4 setting, minimize fan operation when the thermostat is off.
 - Fan operates for 20 seconds at an interval of 5 minutes in heat mode.
 - Fan stops or operates Ultra low in Cooling when the thermostat is off.
- ²⁾ SEG18
If you set the Maximum filter usage time option to a value other than 2 and 6, it is automatically set to 2 (1000 hours).
- ³⁾ SEG20
If you set the Individual control with remote control option to a value other than 0 to 4, it is automatically set to 0 (Indoor1)
- ⁴⁾ SEG21
The default value of the Heating setting compensation is 3.6°F (2°C).



05 series installation option (Detailed)

Option No. : 05XXXX-1XXXXX-2XXXXX-3XXXXX

SEG1		SEG2		SEG3		SEG4		SEG5	SEG6
Page		Mode		Reserved		Reserved		Reserved	Reserved
Indication	Details	Indication	Details						
0		5	Installation Option 2						
SEG7		SEG8		SEG9		SEG10		SEG11	SEG12
Page		Heater lock out		Heat pump lock out		Bit 0 : Allow Fan control in auto mode Bit1 : Onboarding Type(AP / BLE)		0	Reserved
Indication	Details	Indication	Details	Indication	Details	Indication	Details		
1	0	Disuse	0	Disuse	0	Not allow	Ap Onboarding		
	1	65 °F (18.3 °C)	1	45 °F (7.2 °C)	1	allow	Ap Onboarding		
	2	60 °F (15.6 °C)	2	40 °F (4.4 °C)					
	3	55 °F (12.8 °C)	3	35 °F (1.7 °C)	2	Not allow	BLE Onboarding		
	4	50 °F (10.0 °C)	4	30 °F (-1.1 °C)					
	5	45 °F (7.2 °C)	5	25 °F (-3.9 °C)	3	allow	BLE Onboarding		
	6	40 °F (4.4 °C)	6	20 °F (-6.7 °C)					
	7	35 °F (1.7 °C)	7	15 °F (-9.4 °C)	4	Not allow	Ap Onboarding		
	8	30 °F (-1.1 °C)	8	10 °F (-12.2 °C)					
	9	25 °F (-3.9 °C)	9	5 °F (-15 °C)	5	allow	Ap Onboarding		
	A	20 °F (-6.7 °C)	A	0 °F (-17.8 °C)					
	B	15 °F (-9.4 °C)	B	-5 °F (-20.6 °C)	6	Not allow	BLE Onboarding		
	C	10 °F (-12.2 °C)	C	-10 °F (-23 °C)					
	D	5 °F (-15 °C)	D	-15 °F (-26 °C)	7	allow	BLE Onboarding		
E	0 °F (-17.8 °C)	E	-20 °F (-29 °C)						
SEG13		SEG14		SEG15		SEG16		SEG17	SEG18
Page		Reserved		Reserved		Reserved		Reserved	Reserved
Indication	Details								
2									
SEG19		SEG20		SEG21		SEG22		SEG23	SEG24
Page		Reserved		Reserved		Reserved		Reserved	Reserved
Indication	Details								
3									



Final Checks and User Tips

CAUTION

- Do not install the electronic heater in the external supply duct connected to the AHU.

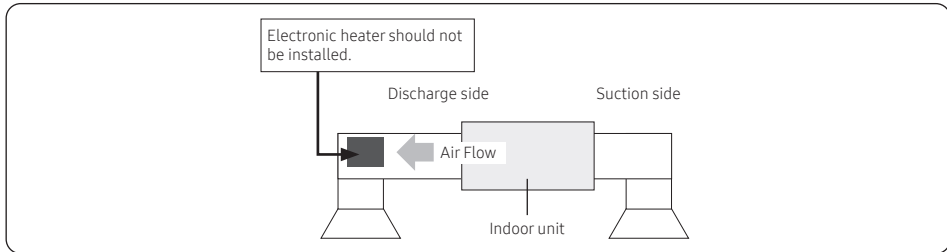

To complete the installation, perform the following checks and tests to ensure that the air conditioner operates correctly. Check the following.

- Strength of the installation site
- Tightness of pipe connection to detect a gas leak
- Electric wiring connections
- Heat-resistant insulation of the pipe
- Drainage
- Earth conductor connection

Providing information for the user

After finishing the installation of the air conditioner, you should explain the following to the user. Refer to the appropriate pages in the User's Manual.

- How to start and stop the air conditioner
- How to select the modes and functions
- How to adjust the temperature and fan speed
- How to set the timers

NOTE

- When you complete the installation successfully, hand over this Installation Manual and the wired controller installation and user manuals to the user for storage in a handy and safe place.





Wi-Fi module reinstallation guide

In some cases, the Wi-Fi module may need to be removed and relocated to improve the Wi-Fi signal connection.

- 1 Disassemble the front frame. (23 screws)

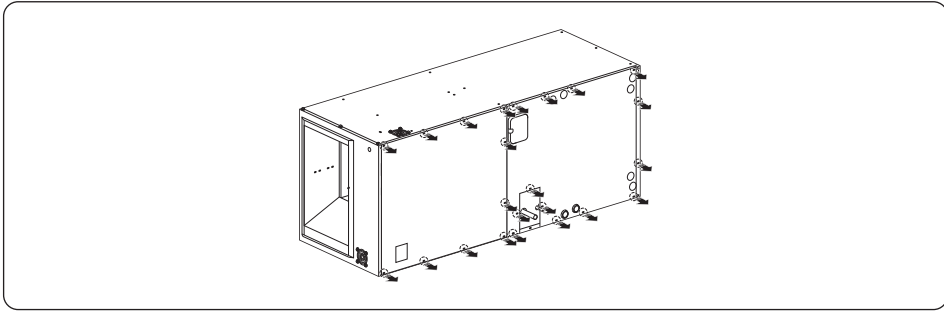

- 2 Disconnect Wi-Fi connector

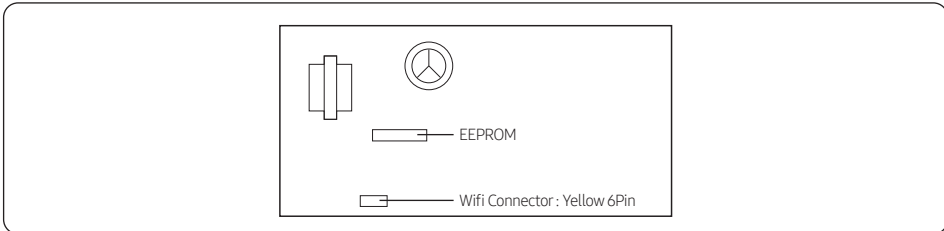

- 3 Pull the Wi-Fi wire through the wiring hole, and then take out the Wi-Fi module..

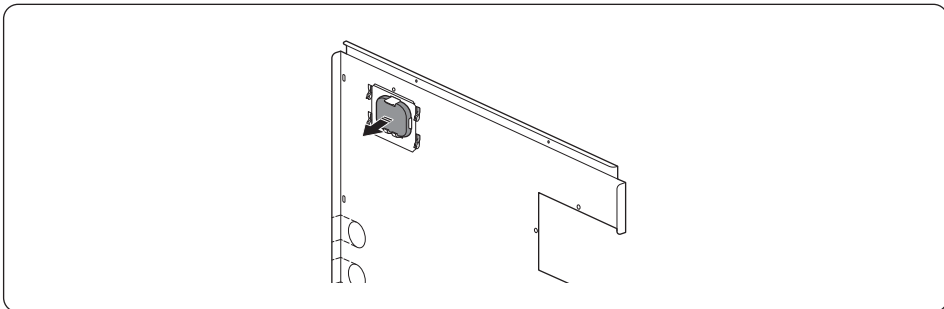



Providing information for the user

- 4 Connect the Wi-Fi wire connector through the wire hole.

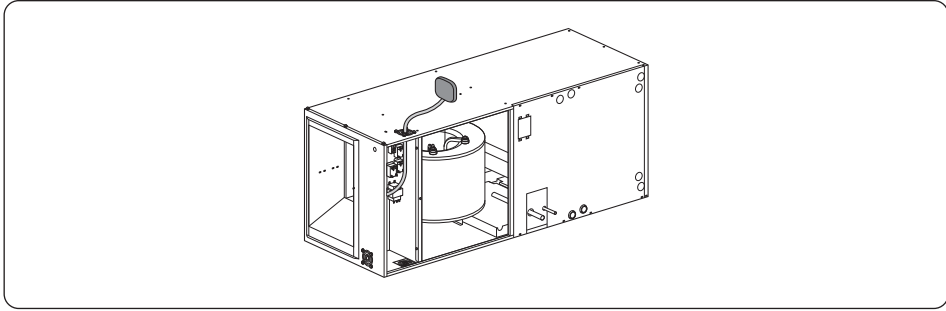

- 5 Assemble the front frame (23 screws)

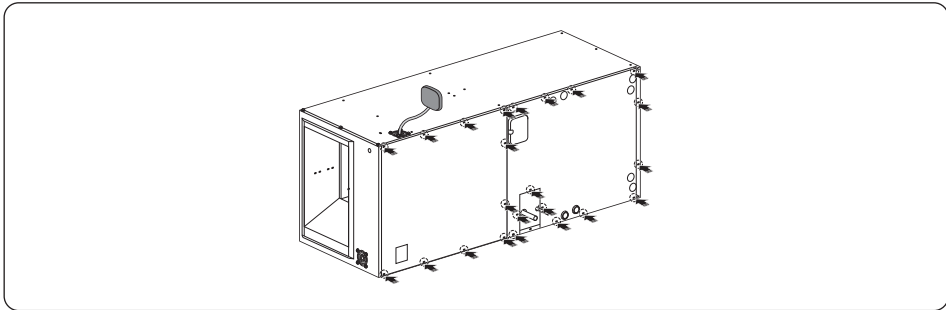

- 6 Fix the Wi-Fi module to the Ceiling to avoid the steel structure.

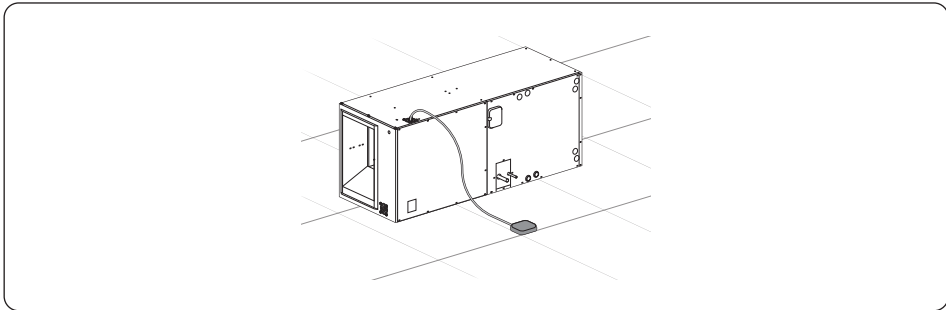









Troubleshooting

- If an error occurs during the operation, one or more LED flickers and the operation is stopped except the LED.
- If you re-operate the air conditioner, it operates normally at first, then detect an error again.

LED Display on the receiver & display unit

Abnormal conditions	Error code	Indicators					Remarks
		Concealed Type		⬆	🌀	📊	
		⏻	⚡				
		GREEN	RED	⬆	🌀	📊	
		Standard Type		⬆	🌀	📊	
⏻	⚡						
Power reset		⬆	X	X	X	X	
Error on indoor temperature sensor (Short or Open)	E121	X	X	⬆	X	X	
1. Error on Eva-in sensor (Short or Open)	E122						
2. Error on Eva-out sensor (Short or Open)	E123	⬆	X	⬆	X	X	
3. Discharge sensor error (Short or Open)	E126						
Error of Fan motor in the indoor unit	E154	X	X	X	⬆	X	
Error of Outdoor	-						
Error indicating a shor/open or fault signal in the refrigerant leak sensor	E116						
Error indicating a primary refrigerant leak detected	E696						
Error indicating a secondary refrigerant leak detected	E697						
Error indicating a malfunction of the refrigerant leak sensor	E698	X	X	⬆	⬆	⬆	
R-32 detection sensor replacement alarm	E699						
R-32 detection sensor unavailable alarm	E700						
Error indicating another indoor unit that shares the outdoor unit detects the R-32 refrigerant.	E797						
Clogging of outdoor's service valve	-	⬆	X	X	⬆	⬆	
1. Detection of the float switch	E153						
2. Emergency alarm system on (Emergency Stop)	E665	X	X	X	⬆	⬆	
1. Error of EEPROM	E162	⬆	⬆	⬆	⬆	⬆	
2. Error of Option setting	E163	⬆	⬆	⬆	⬆	⬆	

Troubleshooting

Abnormal conditions	Error code	Indicators					Remarks
		Concealed Type					
		GREEN	RED				
		Standard Type					
							
1. No communication for 2 minutes between indoor units (Communication error for more than 2 minutes)	E101						
2. The indoor unit receiving the communication error from the outdoor unit	E102						
3. Outdoor unit tracking 3 minutes error	E202	X	X	●	●	X	
4. When sending the communication error from the outdoor unit, the mismatching of the communication numbers and installed numbers after completion of tracking. (Communication error for more than 2 minutes)	E201						

● On ● Flickering X Off

- If you turn off the air conditioner when the LED is flickering, the LED is also turned off.



Wired remote controller

If an error occurs,  is displayed on the wired remote controller. If you would like to see an error code, press the Test button.

Error mode	Contents	Error type
808	Indoor unit communication error	Communication error
808	Duplicated address setting error	Communication error
809	No response error address from indoor unit	Communication error
816	Error indicating a short-circuit, open-circuit or fault signal in the refrigerant leak sensor	R-32 detecting sensor error
818	Indoor fan PCB over heat error	
821	Indoor temperature sensor (open/short error)	Indoor sensor error
822	Indoor unit Eva In sensor (Open/Short)	Indoor sensor error
823	Indoor unit Eva Out sensor (Open/Short)	Indoor sensor error
854	Error of Fan motor in the indoor unit	
862	EEPROM error (Hardware)	Indoor EEPROM error
863	EEPROM option error	Indoor EEPROM error
898	Error on thermal fuse of indoor unit (Open)	Indoor Terminal Block error
202	Indoor/outdoor communication error (1 min)	Communication error
203	Communication error between indoor/outdoor INV↔MAIN MICOM (1 min)	Communication error
221	Outdoor temperature sensor error	Outdoor sensor error
231	COND temperature sensor error	Outdoor sensor error
251	[Inverter] Emission temperature sensor error	Outdoor sensor error
403	Detection of Indoor Freezing (when Comp. Stops)	Outdoor unit protection control error
404	Protection of Outdoor Overload (when Comp. Stops)	Outdoor unit protection control error
416	Emission temperature excessively high	Outdoor unit protection control error



Troubleshooting

Error mode	Contents	Error type
422	High pressure blockage error (Refrigerant completely Leakage error)	Self diagnostic error
440	Heating operation blocked	Self diagnostic error
441	Cooling operation blocked	Self diagnostic error
458	Outdoor fan 1 error	Self diagnostic error
461	[Inverter] Compressor startup error	Outdoor unit protection control error
462	[Inverter] Total current error/PFC over current error	Outdoor unit protection control error
463	OLP Overheat and Comp. Stop	Outdoor unit protection control error
464	[Inverter] IPM over current error	Outdoor unit protection control error
465	Compressor V limit error	Outdoor unit protection control error
466	DC LINK over/low voltage error	Outdoor unit protection control error
467	[Inverter] Compressor rotation error	Outdoor unit protection control error
468	[Inverter] Current sensor error	Outdoor unit protection control error
469	[Inverter] DC LINK voltage sensor error	Outdoor unit protection control error
470	EEPROM Read/Write error	Outdoor unit protection control error
471	[Inverter] OTP error	Outdoor unit protection control error
472	AC ZERO CROSSING SIGNAL OUT error	Outdoor unit protection control error
473	Compressor LOCK error	Outdoor unit protection control error
475	Outdoor fan 2 error	Self diagnostic error
500	IPM Overheat Error for Outdoor Unit Inverter Comp.	Outdoor unit protection control error
554	Gas leak error	Self diagnostic error
557	Option code miss matching among the indoors (only for DPM)	Check indoor option code
556	Capacities not matched	Outdoor unit protection control error
601	Communication error between the indoor unit and wired remote controller	Wired remote controller error



Error mode	Contents	Error type
602	Communication error between the Main and Sub wired remote controllers	Wired remote controller error
604	Error of communication down between the indoor unit and wired remote controller after completion of 10 times tracking.	Wired remote controller error
606	COM1/COM2 Cross-installed error	
608	Error of Main wired remote controller and Sub wired remote controller setting	
665	Emergency alarm system on (Emergency Stop)	
696	Error indicating a primary refrigerant leak detected	R-32 detecting sensor error
697	Error indicating a secondary refrigerant leak detected	
698	Error indicating a malfunction of the refrigerant leak sensor	
699	R-32 detection sensor replacement alarm	
700	R-32 detection sensor unavailable alarm	
797	Error indicating another indoor unit that shares the outdoor unit detects the R-32 refrigerant.	





SAMSUNG

