

Air conditioner

Installation manual

AR**TSFA*** / AR**TSFY***

- Thank you for purchasing this Samsung air conditioner.
- Before operating this unit, please read this user manual carefully and retain it for future reference.



SAMSUNG

Contents

Safety Information	3
Safety Information	3
Installation	6
Preparation	6
Step 1-1 Viewing the typical installation	6
Step 1-2 Verifying model numbers	7
Step 1-3 Choosing the installation location	8
Step 1-4 Unpacking	11
Step 1-5 Preparing materials and tools	12
Indoor Unit Installation	14
Step 2-1 Attaching the mounting bracket to the wall	14
Step 2-2 Drilling the wall penetration	14
Step 2-3 Connecting the refrigerant pipes	15
Step 2-4 Connecting the power and communication cables	16
Step 2-5 Optional: Extending the power cable	17
Step 2-6 Connecting the drain hose	18
Step 2-7 Taping the pipes, cables, and drain hose	19
Outdoor Unit Installation	20
Step 3-1 Mounting the outdoor unit	20
Step 3-2 Connecting the cables and the pipes	21
Installation Inspection and Testing	22
Step 4-1 Performing a drain leak test	22
Step 4-2 Performing pressure tests using nitrogen	22
Step 4-3 Evacuating the system	23
Step 4-4 Adding refrigerant (if needed)	24
Step 4-5 Preparing the system for commissioning	24
Step 4-6 Commissioning the unit	24
Step 4-7 Performing final checks and trial operation	25
Setting the installation options	27
Sub PCB installation(optional)	36

Safety Information



WARNING: Read This Manual

- Read and follow all safety information and instructions before installation, use, or maintenance of this appliance. Incorrect installation, use, or maintenance of this appliance can result in death, serious injury, or property damage. Keep these instructions with this appliance. This manual is subject to change. For the latest version, visit www.samsunghvac.com.

This manual explains how to install a split-system, ductless unit using matched indoor and outdoor units. The manufacturer shall not be responsible for damages arising from the use of non-compatible units.

For information on compatible units and unit specifications, see the submittal document for the applicable model, available at www.samsunghvac.com:

- Submittal AR09TSFACWKXCV/AR09TSFABWKNCV
- Submittal AR12TSFACWKXCV/AR12TSFABWKNCV
- Submittal AR18TSFACWKXCV/AR18TSFABWKNCV
- Submittal AR24TSFACWKXCV/AR24TSFABWKNCV
- Submittal AR09TSFABWKXCV/AR09TSFABWKNCV
- Submittal AR12TSFABWKXCV/AR12TSFABWKNCV
- Submittal AR18TSFABWKXCV/AR18TSFABWKNCV
- Submittal AR24TSFABWKXCV/AR24TSFABWKNCV
- Submittal AR09TSFYBWKXCV/AR09TSFYBWKNCV
- Submittal AR12TSFYBWKXCV/AR12TSFYBWKNCV
- Submittal AR18TSFYBWKXCV/AR18TSFYBWKNCV
- Submittal AR24TSFYBWKXCV/AR24TSFYBWKNCV

Because the instructions in this manual cover various models, the characteristics of your air conditioner may differ slightly from those described. If you have any questions, please contact your service provider or visit www.samsunghvac.com.

This device complies with Industry Canada license exempt RSS standard(s). Operation is subject to the following two conditions: (1) this device may not cause harmful interference and (2) this device must accept any interference received, including interference that may cause undesired operation. This Class B digital apparatus complies with Canadian ICES-003.

This equipment complies with FCC and IC RSS-102 radiation exposure limits set forth for an uncontrolled environment. This equipment should be installed and operated with minimum distance 23.62 inch (600mm) between the radiator & your body. Any changes or modifications not expressly approved by the manufacturer could void manufacturer's warranty.

This product has been designed and manufactured to meet ENERGY STAR criteria for energy efficiency when matched with appropriate coil components.

However, proper refrigerant charge and proper air flow are critical to achieve rated capacity and efficiency. Installation of this product should follow the manufacturer's refrigerant charging and air flow instructions.

Failure to confirm proper charge and air flow may reduce energy efficiency and shorten equipment life.



Safety Information

Notices and notes

To make you aware of safety messages and highlighted information, we use the following notices and notes throughout this manual:

WARNING

Hazards or unsafe practices that may result in severe personal injury or death.

CAUTION

Hazards or unsafe practices that may result in minor personal injury or property damage.

IMPORTANT

Information of special interest

NOTE

Supplementary information that may be useful

FOR GENERAL

California Proposition 65 Warning (US)

 **WARNING:** Cancer and Reproductive Harm - www.P65Warnings.ca.gov.

WARNING

The installation and testing of this appliance must be performed by a qualified technician.

- The instructions in this manual are not intended as a substitute for proper training or adequate experience in the safe installation of the appliance.

Always install the air conditioner in compliance with current local, state, and federal safety standards.

General information

- The air conditioner should be used only for the applications for which it has been designed: the indoor unit is not suitable to be installed in areas used for laundry.

Installation of the product

- Our units must be installed in compliance with the spaces indicated in the installation manual to ensure either accessibility from both sides or ability to perform routine maintenance and repairs. The units' components must be accessible and that can be disassembled in conditions of complete safety either for people or things. For this reason, where it is not observed as indicated into the Installation Manual, the cost necessary to reach and repair the unit (in safety, as required by current regulations in force) with slings, trucks, scaffolding or any other means of elevation won't be considered in-warranty and will be charged to end user.

Power supply line, fuse, or circuit breaker

- Be sure not to perform power cable modification, extension wiring, and multiple wire connection.
 - It may cause electric shock or fire due to poor connection, poor insulation, or current limit override.
 - When extension wiring is required due to power line damage, refer to "Step 2-5 Optional: Extending the power cable" in the installation manual.

Preparation

Step 1-1 Viewing the typical installation

A typical installation will be similar to the one shown below.

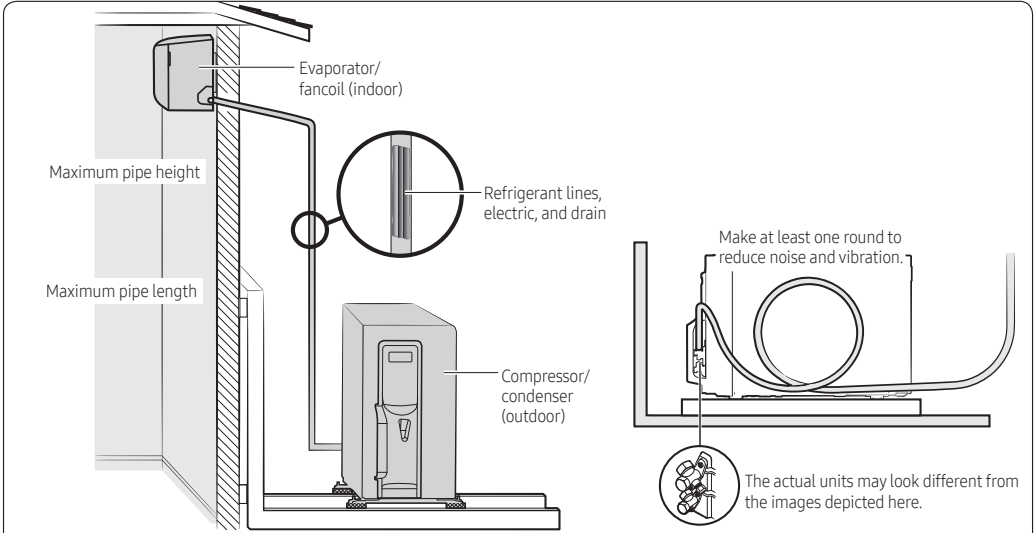

Model	Pipe length			Pipe height
	Minimum	Maximum	Standard for factory charge	Maximum
09***	9.8(3)	65.6(20)	24.6(7.5)	49.2(15)
12***	9.8(3)	98.4(30)	24.6(7.5)	65.6(20)
18***				
24***				

Unit : ft(m)

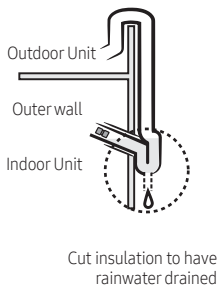

Make a U-trap (A) on the pipe (which is connected to the indoor unit) at outer wall and cut the bottom part of the insulation (about 10 mm) to prevent rainwater from getting inside through the insulation.

Step 1-2 Verifying model numbers

Check the model numbers on the boxes to make sure that the indoor and outdoor units are compatible with each other. For compatible units, see the model's submittal document, listed on page 3.

Nominal capacity (BTU/hour)	Indoor unit model number	Outdoor unit model number
9000	AR09TSFABWKNCV	AR09TSFACWKXCV
12000	AR12TSFABWKNCV	AR12TSFACWKXCV
18000	AR18TSFABWKNCV	AR18TSFACWKXCV
21000	AR24TSFABWKNCV	AR24TSFACWKXCV
9000	AR09TSFABWKNCV	AR09TSFABWKXCV
12000	AR12TSFABWKNCV	AR12TSFABWKXCV
18000	AR18TSFABWKNCV	AR18TSFABWKXCV
21000	AR24TSFABWKNCV	AR24TSFABWKXCV
9000	AR09TSFYBWKNCV	AR09TSFYBWKXCV
12000	AR12TSFYBWKNCV	AR12TSFYBWKXCV
18000	AR18TSFYBWKNCV	AR18TSFYBWKXCV
22000	AR24TSFYBWKNCV	AR24TSFYBWKXCV

Preparation

Step 1-3 Choosing the installation location

If using a multi system, install as described in the installation manual supplied with the outdoor unit.

WARNING

- Verify that a dedicated circuit breaker and a disconnect switch of the appropriate sizes for the air conditioner are preinstalled and available for use. See the submittal document for the model, listed on page 3.
- Verify that the voltage and frequency of the power supply comply with the rated voltage as defined on the unit name plate.
- Verify that a suitable grounding connection is available.
- Do not install this appliance in an environment containing hazardous substances or close to equipment that releases open flames.
- Do not install this appliance near a heater or flammable material.

CAUTION

- The manufacturer shall not be responsible for damage occurring as a result of the wrong voltage being applied to this air conditioner.
- The indoor and outdoor units must be installed in compliance with minimum clearances to ensure that both units are accessible from both sides and can be maintained or repaired. Insufficient clearance may reduce product performance, generate excessive noise, and reduce the life of some unit components.

IMPORTANT

- Any changes or modifications to the installation described in this manual that are not expressly approved by the manufacturer could void the manufacturer's warranty.

To determine where to locate the indoor and outdoor units, you must survey the entire site and consider many variables. The goal is to select locations that comply with all safety precautions while also minimizing the total effort involved.

Indoor unit location requirements

WARNING

- Do not install the unit in a humid, oily, or dusty location or in a location exposed to direct sunlight, water, or rain.
- Make sure that the wall can support the unit weight.

Examine the area that the customer wants to be air conditioned. Consider the following:

- What wall location will meet minimum clearances and provide optimal product performance?
- Will the wall provide adequate support for the unit weight (wall with stud construction or concrete)? If applicable, where are the studs?
- Where will you place the wall penetration for routing the piping bundle (consisting of power and communication cables, refrigerant pipes, and the drain hose) through the wall to the outdoor unit? Will the hole intersect any plumbing or wires in the wall?
- Is the location as close as possible to where the outdoor unit will be installed, to minimize the length of piping and cables?
- Will the condensate drain inside the room, through the wall penetration to the outdoor unit, or be connected to a condensate pump?

NOTE

- This manual covers a typical gravity-drain installation where the drain hose is routed to the outdoor unit through a hole in the wall.

Minimum clearances for the indoor unit

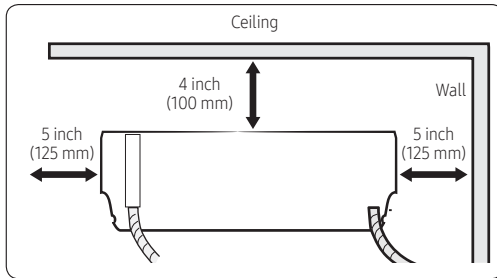

Outdoor unit location requirements

Examine the area where the outdoor unit could be located. Consider the following:

- What location will meet minimum clearances and provide optimal product performance?
- Is there an existing level and hard foundation, such as a concrete pad, that will support the unit weight and produce minimal vibration? Installation on uneven ground may result in abnormal vibrations, noise, or problems with the unit.
- Does the unit need to be mounted on the wall?
- Where are the dedicated circuit breaker and disconnect switch located? How will you connect them to the unit?
- How will you route the piping bundle from the indoor unit? Is the location as close as possible to where the indoor unit will be installed, to minimize the length of piping and cables?
- Will the unit be sheltered from the wind? In a high-wind area, you may need to build a protective fence around the unit.
- Where will the condensate drain?

WARNING

- The drain location must allow condensate to drain properly and prevent ice from forming on the unit in winter. If a block of ice falls from the unit, it may result in death, serious injury, or property damage. Improper or inadequate draining may result in water overflowing and property damage.

CAUTION

- Do not connect the drain hose to existing waste pipes as odors may arise.

Installation on an exterior wall

If the outdoor unit must be installed on an exterior wall, you will need an L-bracket to support the unit. This bracket is not included with the unit.

WARNING

- The wall must be capable of supporting the weight of both the L-bracket and the outdoor unit. If the unit falls, it may result in crushing, electric shock, fire, or explosion that could cause death, severe personal injury, or property damage.

Installation Guide at the seashore

Make sure to follow below guides when installing at the seashore.

- 1 Do not install the product in a place where it is directly exposed to sea water and sea breeze.
 - Make sure to install the product behind a structure (such as building) that can block sea breeze.
 - Even when it is inevitable to install the product in seashore, make sure that product is not directly exposed to sea breeze by installing a protection wall.
- 2 Consider that the salinity particles clinging to the external panels should be sufficiently washed out.
- 3 Because the residual water at the bottom of the outdoor unit significantly promotes corrosion, make sure that the slope does not disturb drainage.
 - Keep the floor level so that rain does not accumulate.
 - Be careful not to block the drain hole due to foreign substance.
- 4 When product is installed in seashore, periodically clean it with water to remove attached salinity.
- 5 Make sure to install the product in a place that provides smooth water drainage. Especially, ensure that the base part has good drainage.
- 6 If the product is damaged during the installation or maintenance, make sure to repair it.

Preparation

- 7 Check the condition of the product periodically.
- Check the installation site every 3 months and perform anti-corrosion treatment such as R-Pro supplied by SAMSUNG (Code : MOK-220SA) or commercial water repellent grease and wax, etc., based on the product condition.
 - When the product is to be shut down for a long period of time, such as off-peak hours, take appropriate measures like covering the product.
- 8 If the product installed within 1640.4 ft (500 m) of seashore, special anti-corrosion treatment is required.
- ※ Please contact your local SAMSUNG representative for further details.

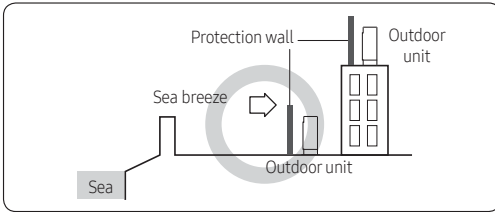
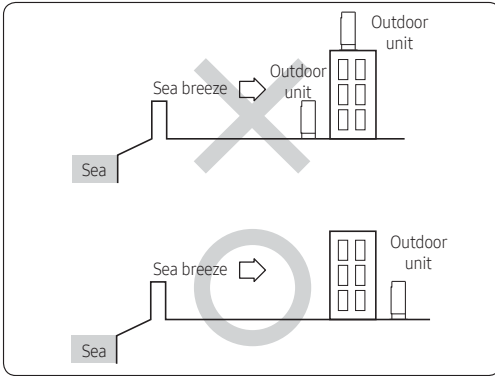

- Protection wall should be constructed with a solid material that can block the sea breeze and the height and width of the wall should be 1.5 times larger than the size of the outdoor unit. (You must secure more than 2296.6 ft (700 mm) of space between the protection wall and the outdoor unit for air circulation.)

Minimum clearances for the outdoor unit

Legends:

Wall
Minimum clearance in inch (mm)
Air flow direction

Examples for installing one outdoor unit:

Unit: inch (mm)

Examples for installing multiple outdoor units:

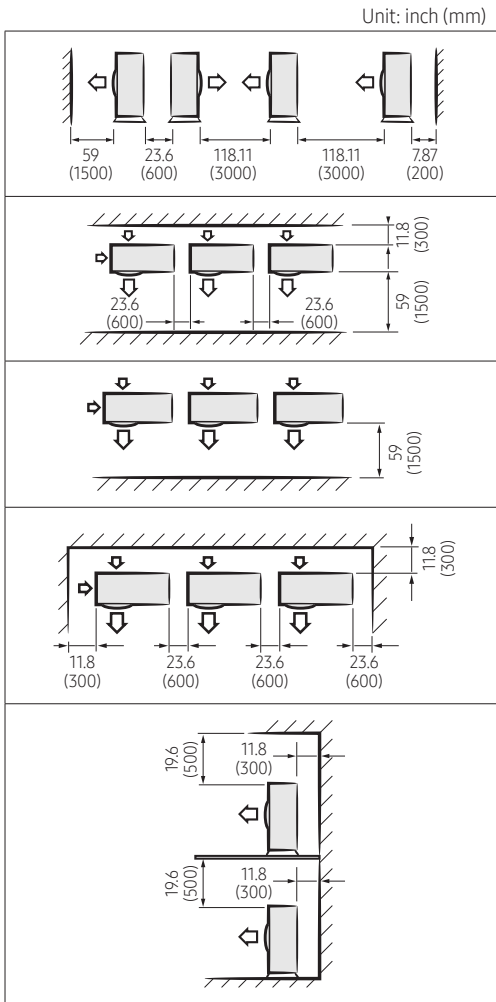

Step 1-4 Unpacking

Upon receipt, inspect the product to verify that it has not been damaged during transport. If the product appears damaged, do not install it and immediately report the damage to your local Samsung distributor.

Packing material must be disposed of in accordance with local regulations.

Unpacking the indoor unit

At the selected indoor unit location:

- 1 Open the indoor unit package.
- 2 Remove the left and right cushions.
- 3 Carefully remove the unit from the package.
- 4 Place the unit on a flat surface where it will be protected from possible damage.

Unpacking the outdoor unit

At the selected outdoor unit location:

- 1 Remove the package.
- 2 Remove the top cushion.
- 3 Carefully remove the unit from the bottom cushion.
- 4 Place the unit on a flat surface where it will be protected from possible damage.

Preparation

Step 1-5 Preparing materials and tools

Materials in the indoor unit package

Make sure that the indoor unit package contains the following materials:

<p>Mounting bracket (1) **07/09/12***** **15TSA**</p>	<p>Mounting bracket (1) **15TSFY** **18/24*****</p>
<p>Remote control (1)</p>	<p>Remote control battery (2)</p>
<p>Quick Guide for User (1)</p>	<p>Quick Guide for Installer (1)</p>
<p>Extra M4 x12 tapping screw (2)</p>	<p>Holder remocon (1)</p>

Materials in the outdoor unit package

Make sure that the outdoor unit package contains the following materials:

<p>Rubber foot (4)</p>	<p>Drain plug (1) **09/12/18***** **24TSFY** **24TSFAC**</p>
<p>Drain plug (2) **24TSFAB**</p>	

If using a multi system, install as described in the installation manual supplied with the outdoor unit.

Optional accessories

For information on the accessories that are available for each model, see the submittal documents listed on page 3.

Materials supplied by the installer

Make sure you have all other materials required for the selected installation method and location.

IMPORTANT

- No mounting hardware, tubing, cables, and other materials listed below are included with the appliance.

The required materials will vary, but may include the following:

- 6-ft electrical whip for connecting the power from the installed disconnect switch to the outdoor unit
- UV-resistant vinyl line set tape for the exposed line set
- Lines-set cover and fittings, if used
- Miscellaneous pipe hangers
- Miscellaneous screws and anchors for hanging pipe hangers, the line-set cover, the indoor unit mounting plate, and so on.
- Electrical ring connectors for connecting all power and communication wiring
- Electrical tape
- Refrigerant R-410A if additional refrigerant is required due to line-set length
- Closed cell foam tape insulation (roll)
- Outdoor unit risers or L-brackets for wall installation
- Silicone caulking for sealing the wall penetration
- Rags

Piping and cables

Connecting the indoor and outdoor units requires a premanufactured refrigeration line set (recommended) or a line set assembled by the installer that includes.

- Soft-copper line set insulated with closed-cell foam insulation
- 18 shielded cable, for communication (F1/ F2) wiring
- 14/3 flexible metallic underground cable with green grounding wire, for power wiring from the outdoor unit to the indoor unit
- 5/8-inch ID drain hose with adapter fitting, for gravity drain applications that require an extension
- Make sure that the line set is longer than is needed to reach from the indoor to the outdoor unit, to allow for bends and final connections. For more on pipe lengths, see Step 1-1 Viewing the typical installation on page 6.
- If not using a premanufactured line set:
 - Only use insulated seamless refrigeration-grade copper pipe (Cu DHP-type according to ISO1337),

degreased and deoxidized, suitable for operating pressures of at least 609 psig (4200 kPa) and for a burst pressure of at least 3002 psig (20700 kPa).

- Do not use sanitary-type copper pipe under any circumstances.
- Use standard cables.

Cable	Terminal	Wire Specification
Power cable	L1, L2, ground	16AWG (for **09*****, **12*****, **18TSFY**)
		12AWG (for **18TSFA**, **24*****)
Communication cable	F1, F2	18AWG Standard shield cable

NOTE

- This manual does not include instructions for extending cables. If you need to extend the cables, follow local codes.

Tools

Make sure you have the required tools available.

Safety tools

- Service disconnect lock and tag
- Circuit breaker lock and tag
- Safety glasses
- Cut-proof gloves
- Hearing protection
- Hard hat, for use in appropriate areas
- Safety vest, for visibility as required

General tools

- 36-inch spirit level
- 8-inch to 9-inch torpedo level
- Cordless drill

- #2 Phillips-bit driver for cordless drill
- Phillips screw driver
- Slotted screw driver
- Corded hammer drill, for masonry anchors if used
- Masonry drill bit, for masonry anchors if used
- Compact bandsaw, for cutting all thread and/or unistrut channel as required
- Stud finder, for stud-wall construction as required
- 2-5-inch hole saw, standard, or diamond core for concrete or cinder block construction
- Metric hex-key set
- Razor knife
- 25-ft tape measure

Electrical tools

- Clamp-on multimeter, for measuring volt AC, resistance, and amperage
- Non-contact thermometer (may be incorporated into multimeter)
- Wire strippers
- Wire connector crimping tool
- Cutting pliers

Piping tools

- Flaring tool
- Deburring tool
- Piping bender, spring type
- Tubing cutter, imp style
- Tubing cutter, standard style
- Open-end torque wrench (ft.-lbs.)
- Crescent wrench

Refrigeration tools

- Manifold set for R-410A
- 5/16-inch to 1/4-inch flare adapter
- Shrader core removal tool
- 2-stage vacuum pump with oil
- Electronic refrigerant scale (lbs/oz), if additional refrigerant is required due to line length
- Recovery machine with tank, if required
- Micron vacuum gauge
- 1/4-inch vacuum gauge hose tee
- Nitrogen regulator
- Nitrogen cylinder, charged

Indoor Unit Installation

Step 2-1 Attaching the mounting bracket to the wall

- 1 Hold the mounting bracket against the wall at the selected installation position (Step 1-3 on page 8), making sure that the screw holes align with the center of the studs in the wall. If the screw locations do not align with the studs, use wall anchors.

CAUTION

- The recommended best practice is to attach the mounting bracket directly to the studs in the wall. If you did not find a suitable location with studs (in Step 1-3 on page 8), or if the wall is concrete, you must use wall anchors of a suitable type and weight capacity, and install them according to the manufacturer's instructions. Failure to do so may cause the material surrounding the joints to crumble over time and the screws to be loosened and stripped. This may result in the unit falling from the wall, which could cause physical injury or equipment damage.
- 2 Using a level, make sure that the mounting bracket is level, then mark the location of the screw holes on the wall.
 - 3 If using wall anchors, install them at the screw hole positions, following the manufacturer's instructions.
 - 4 Using six field-supplied mounting screws and anchors (if applicable), attach the bracket to the wall.

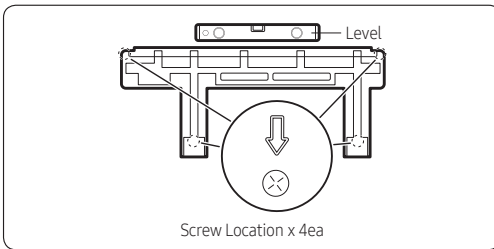

Step 2-2 Drilling the wall penetration

- 1 Determine the position of the hole through which the piping bundle (consisting of power and communication cables, refrigerant pipes, and the drain hose) will pass. Consider the following:
 - The hole inner diameter must be 2.5 inches (65 mm).
 - The recommended hole location is behind the unit so that the hole and the piping bundle will not be visible in the room. The minimum distances between the hole and the mounting bracket are:

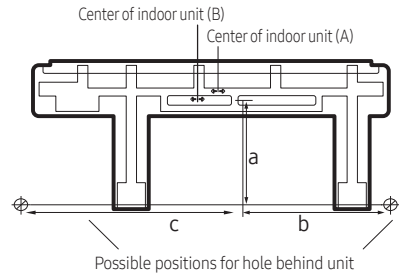

Unit: inch(mm)

Model		a	b	c
07TSFY*				
09TSFY*	A	6.49(165)	12.00(305)	16.37(416)
12TSFY*				
07TSFA*				
09TSFA*	B	6.49(165)	12.00(305)	19.13(486)
12TSFA*				
15TSFA*				
15TSFY*				
18***	A	5.90(150)	12.00(305)	25.61(650.5)
24***				

- If the hole cannot be positioned behind the unit, find a position as close to the unit as possible. The piping bundle that exits the unit and extends to the hole will need to be attached to the wall and will be visible inside the room.
- In relation to the bracket shown above, the unit is shipped with the drain hose connection on the right, the drain hose exits the unit on the left, and the refrigerant pipes are bent to exit on the left. Thus, positioning the hole to the left (A/B or outside the unit) requires the least effort. If you position the hole to the right (C/D or outside the unit) or below the unit, you will need to move the drain hose connection to the left and bend the pipes so that the hose and pipes exit to the right or bottom. See the figure in step 3 on page 15.

- Use a standard 2-5-inch (65-mm) hole saw to drill one hole at the selected location, at a 15° downward angle so that the drain hose will drain properly.

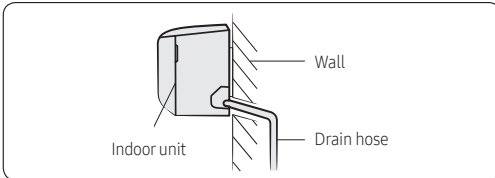

- Based on the hole location, determine where the piping bundle (drain hose, refrigerant pipes, and cables) will exit the unit.

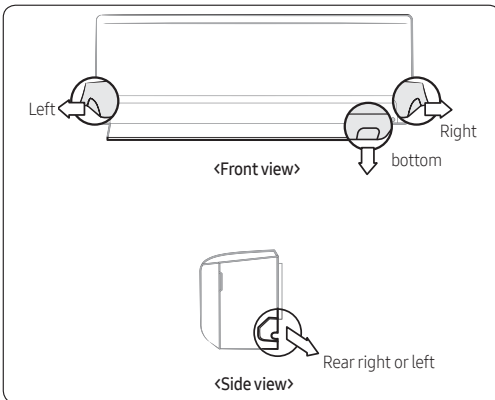

NOTE

- The left, right, or bottom exit will only be used if the hole is not positioned behind the unit.

Step 2-3 Connecting the refrigerant pipes

Connect indoor and outdoor units with field-supplied copper pipes by means of flare connections. Use insulated seamless refrigeration grade pipe only, (Cu DHP type according to ISO1337), degreased and deoxidized, suitable for operating pressures of at least 4200 kPa and for burst pressure of at least 20700 kPa. Under no circumstances must sanitary type copper pipe be used.

IMPORTANT

- When installing the unit, always connect the refrigerant pipes first, followed by the electrical cables. For disassembly, always disassemble the electric cables before the refrigerant pipes.

Two short refrigerant pipes are already attached to the air conditioner:

- The smaller-diameter pipe is for the high-pressure, two-phase refrigerant.
- The larger-diameter pipe is for the low-pressure refrigerant vapor.

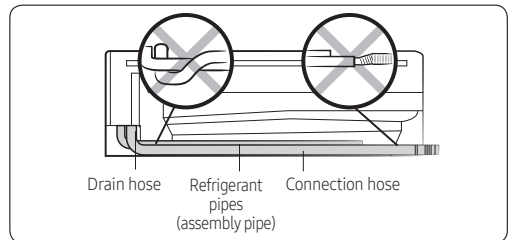

In Step 2-3, step 3 you determined the exit position for the piping bundle. The unit has three knockouts available for the left, right, and bottom exits. When the bundle exits directly from the rear, none of the knockouts are used.

- If the pipes will exit directly from the rear, skip to step 3. Otherwise, cut out the appropriate knockout piece (left, right, or bottom).
- Use a razor knife to clean the cut edges (flashing).
- The left exit is the only position that does not require bending the pipes. For other positions, bend the pipes so that they will exit in the selected exit position.
 - The bending radius should be greater than 4 inch (100 mm).
 - Bend the smaller pipe gradually to prevent kinking. The larger pipe has a preinstalled spring bender to prevent kinking.
 - Make sure that the pipes do not protrude from the back of the unit in a way that will make it difficult to attach the unit to the mounting bracket.
 - For right and bottom exits, pull the pipes out through the selected knockout opening. For left exits, the piping connections will be made in the service space behind the indoor unit (under the cover panel).

Indoor Unit Installation

NOTE

- If you are using the right rear exit, the pipes should be long enough to extend through the wall without needing to connect the line set first. It may be easier to connect the line set outside of the building, after you have bundled the pipes and cables and passed the bundle through the wall. In this case, do not connect the line set now. Instead, complete Step 2-5 through Step 2-9, then go outside and connect the line set as described below.
- Slowly remove the protective caps on the refrigerant pipe connections to relieve the nitrogen holding charge.
 - Connect the line set to each pipe.

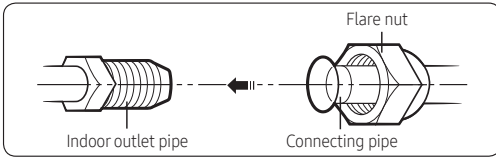

- Hand-tighten the flare nuts to make sure that they do not become stripped.

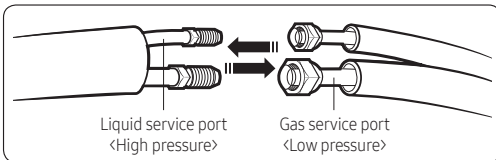

- Torque the flare connections to the following values:

Outer diameter	Torque ft-lb (N-m)
1/4 inch (6.35 mm)	10.1-13.0 (14-18)
3/8 inch (9.52 mm)	25.3-31.1 (34-42)
1/2 inch (12.70 mm)	36.2-44.8 (49-61)
5/8 inch (15.88 mm)	49.9-60.0 (68-82)

CAUTION

- Tighten the flare nuts only to the specified torque. If a flare nut is overtightened, the flare face may crack, causing refrigerant leakage.
- Do not box in or cover the pipe connections. Make sure that the connections are accessible for testing later in the installation process and for future servicing.

- Tape over the end of the pipes so that debris will not enter the piping when it is passed through the wall. The pipes will be insulated later in the installation process.

Step 2-4 Connecting the power and communication cables

If using a multi system, install as described in the installation manual supplied with the outdoor unit.

WARNING

- Do not modify the power cable in any way. Doing so may cause electric shock or fire due to poor connection, poor insulation, or current limit override. Make sure to comply with the technical standards of electrical installations and the wiring regulations in the local area.
 - This appliance must be properly grounded. Do not ground the appliance to a gas pipe, plastic water pipe, or telephone line. Failure to comply may result in electric shock, fire, and explosion.
- Connect each wire to its corresponding terminal number.

Cable	Terminals
Power cable	L1, L2, ground
Communication cable	F1, F2

Before connecting				
	Correct	Upside down	Damaged	Non-circular
After connecting				
	Correct (Front view)	Correct (Side view)	Upside down	Non-fitted

<Circular terminal>

⚠ CAUTION

- Connect the wires firmly so that wires cannot be pulled out. Loose wires can cause the connection to overheat. Each circular terminal must match the size of its corresponding screw in the terminal block.

⚠ CAUTION

- For the terminal block wiring, use a wire with a ring terminal socket only. Regular wires without a ring terminal socket may become a hazard as the connections may loosen during operation.

2 Tighten the terminal block screw.

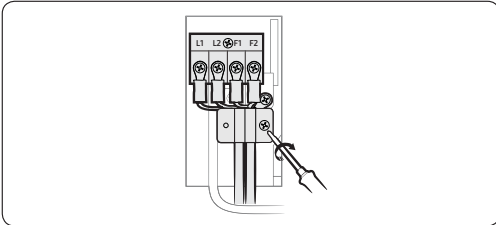

3 In Step 2-3, step 3 you determined the exit position for the piping bundle. If using the left, right, or bottom exits, pass the cables through the selected knockout.

📄 NOTE

- Power supply cords of parts of appliances for outdoor use shall not be lighter than polychloroprene sheathed flexible cord.
- Power & Communication cable shall not exceed 98.42ft(30 m).

Step 2-5 Optional: Extending the power cable

1 Prepare the following tools.

Tools	Spec	Shape
Crimping pliers	MH-14	
Connection sleeve (mm)	0.78xØ0.25inch (20xØ6.5mm) (HxOD)	
Insulation tape	Width 0.74inch(19 mm)	
Contraction tube (mm)	2.75xØ0.31inch (70xØ8.0 mm) (LxOD)	

2 As shown in the figure, peel off the shields from the

rubber and wire of the power cable.

- Peel off 0.79inch (20 mm) of cable shields from the pre-installed tube.

⚠ CAUTION

- For information about the power cable specifications for indoor and outdoor units, refer to the installation manual.
- After peeling off cable wires from the pre-installed tube, insert a contraction tube.
- If cable wires are connected without using connecting sleeves, their contact area becomes reduced, or corrosion develops on the outer surfaces of the wires (copper wires) over a long time. This may cause an increase of resistance (reduction of passing current) and consequently may result in a fire.

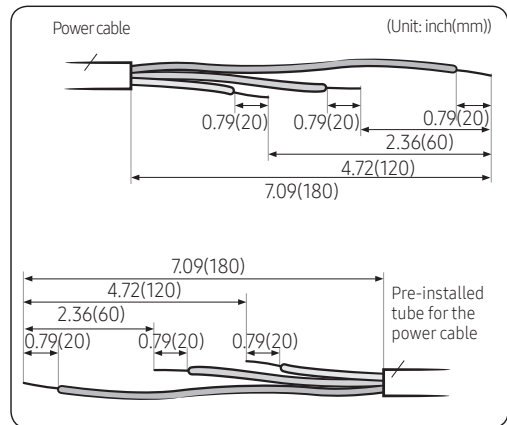

3 Insert both sides of core wire of the power cable into the connection sleeve.

- Method 1:** Push the core wire into the sleeve from both sides.
- Method 2:** Twist the wire cores together and push it into the sleeve.

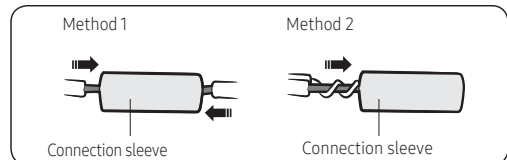

Indoor Unit Installation

- 4 Using a crimping tool, compress the two points and flip it over and compress another two points in the same location.
- The compression dimension should be 8.0.

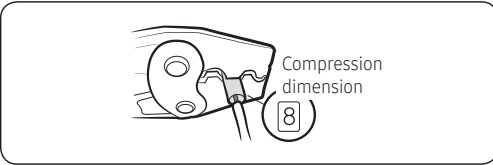

- After compressing it, pull both sides of the wire to make sure it is firmly pressed.

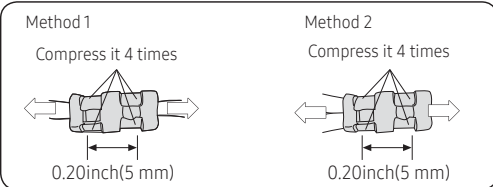

- 5 Wrap it with the insulation tape twice or more and position your contraction tube in the middle of the insulation tape.

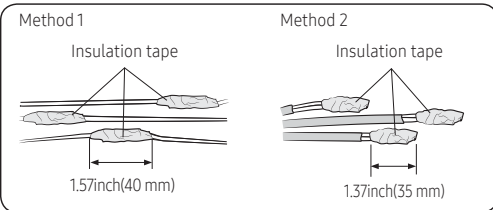

- 6 Apply heat to the contraction tube to contract it.

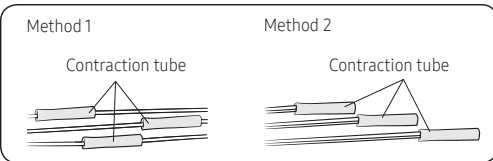

- 7 After tube contraction work is completed, wrap it with the insulation tape to finish. Three or more layers of insulation are required.

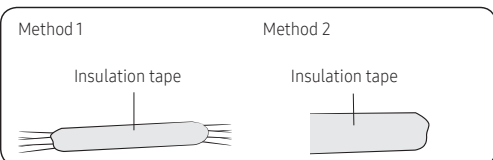

⚠ CAUTION

- Make sure that the connection parts are not exposed to outside.
- Be sure to use insulation tape and a contraction tube made of approved reinforced insulating materials that have the same level of withstand voltage with the power cable. (Comply with the local regulations on extensions.)

⚠ WARNING

- In case of extending the electric wire, please DO NOT use a round-shaped Pressing socket.
 - Incomplete wire connections can cause electric shock or a fire.

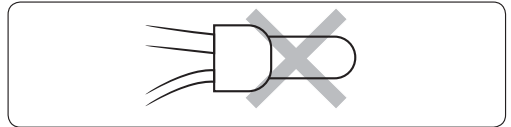

Step 2-6 Connecting the drain hose

- 1 In Step 2-3, step 3 you determined the exit position for the piping bundle. If using the right, bottom, or right rear exit, change the drain hose connection from the right to the left so that the drain hose will lie along the inside of the unit and exit to the right.

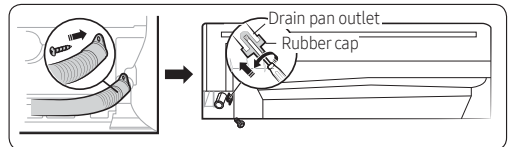

CAUTION

- Be careful not to puncture the plug with the screwdriver when installing it.
- 2 If using the left, right, or bottom exit, pass the drain hose through the selected knockout.

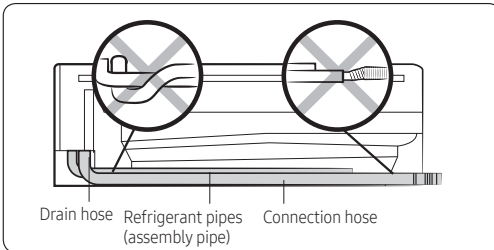

- 3 Connect a 5/8-inch ID extension drain hose to the main drain hose.

CAUTION

- If the diameter of the connection hose is smaller than the product's drain hose, leakage may occur.

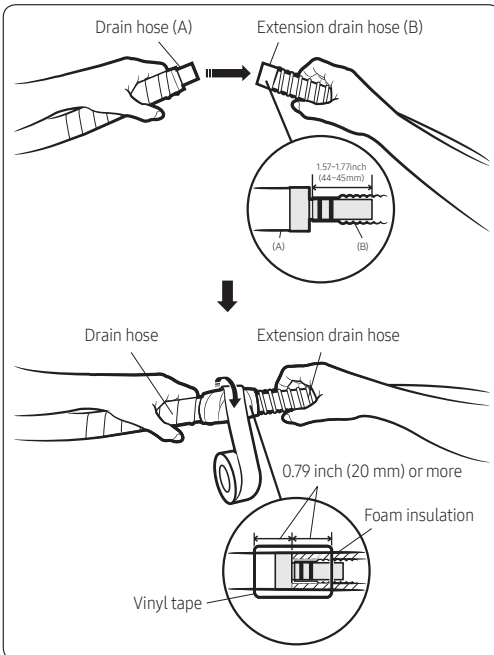

- 4 Do not box in or cover the drain hose connection. It must be accessible for testing later in the installation process and for future servicing.
- 5 If the drain hose is routed inside the room, insulate the hose so that dripping condensation does not damage the furniture or floors.

Step 2-7 Taping the pipes, cables, and drain hose

- 1 Wrap foam insulation around the refrigerant pipes up to the connection points. The connections must remain accessible for testing later in the installation process. Either leave slits in the insulation or do not cover the connections.

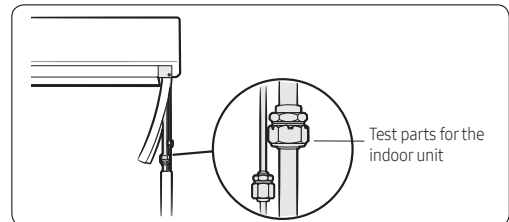
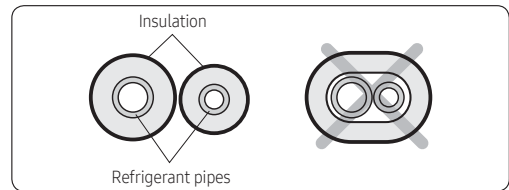

- 2 Make a piping bundle by using vinyl tape to wrap together the refrigerant pipes, power cable, communication cable, and drain hose, up to the connection points. Connection points must remain accessible for testing later in the installation process.

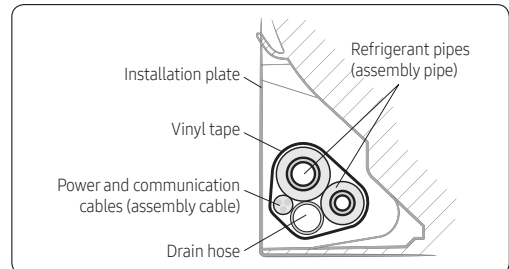

Outdoor Unit Installation

If using a multi system, install as described in the installation manual supplied with the outdoor unit.

Step 3-1 Mounting the outdoor unit

To promote proper condensate draining, the recommended installation of the outdoor unit is elevated above the ground on a mounting bracket attached to a concrete pad.

In areas where snowfall occurs, the unit must be mounted above the snow line to allow for proper heating. Snow cannot be allowed to collect on top of the unit. For promoting natural drainage in a heavy snow fall area:

- Make space more 3.14 inch (80 mm) between the bottom of the outdoor unit and the ground for installation. (Ensure that the drained water runs off correctly and safely.)
- Allow enough separation distance between the product and the ground.

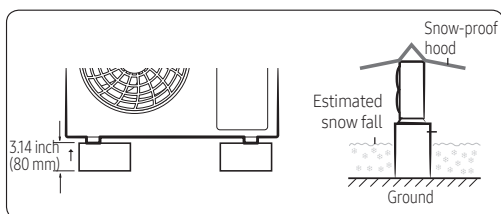

On the ground

- 1 Place the outdoor unit in the selected installation location (Step 1-1 on page 6), ensuring proper clearances and with the arrow on top of the unit pointing away from the wall.
- 2 Clip the rubber feet to the tabs to minimize sound and vibration to the structure.

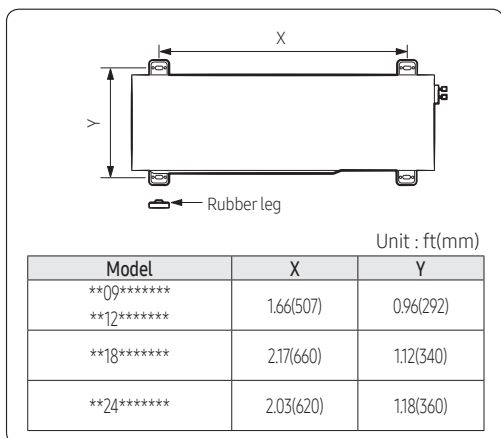

- 3 Level the unit, then use anchor bolts to secure it at the four mounting points.
- 4 For installations in locations that require seismic or hurricane tie downs, comply with local codes.
- 5 If the selected location is exposed to strong winds, install a protective fence around the unit so that the fan can operate correctly.

On a wall

! WARNING

- The unit must be properly secured to the wall. If the unit falls, it may result in crushing, electric shock, fire, or explosion that could cause death, severe personal injury, or property damage.

- 1 At the selected installation location (Step 1-1 on page 6), attach the L-bracket to the wall as follows:
 - Install the bracket as close to the wall as possible.
 - Insert rubber isolators between the bracket and the wall to minimize sound and vibration to the structure. Do not fully compress the isolators.

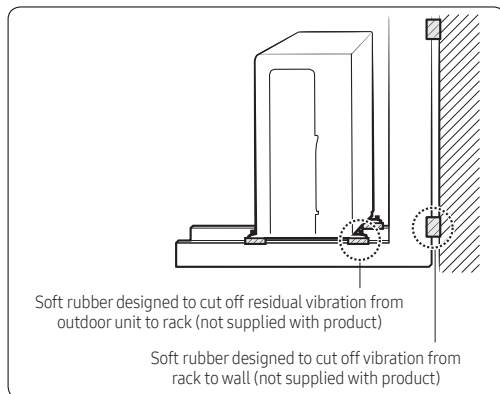

- Make sure that the bracket is level.
 - Use suitable bolts/washers and lock washers.
- 2 Place the outdoor unit on the bracket, ensuring proper clearances and with the arrow on top of the unit pointing away from the wall.
 - 3 Clip the rubber feet to the tabs to minimize sound and vibration to the structure.
 - 4 Level the unit, then use anchor bolts to secure it at the four mounting points.
 - 5 For installations in locations that require seismic or hurricane tie downs, comply with local codes.

Step 3-2 Connecting the cables and the pipes

- 1 Route the piping bundle to the outdoor unit.
- 2 Use piping clamps to fasten the piping bundle to the foundation or wall.
- 3 Cut the refrigerant pipes to the length needed to reach the pipe connections (located behind the cover panel; see the figure in step 7).

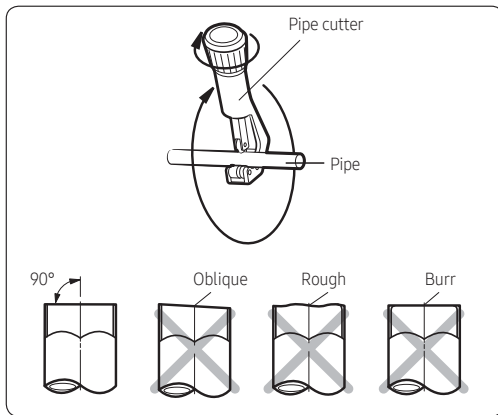

- 4 Remove any burrs, positioning the pipe face down to make sure that the burrs do not get into the pipe.
- 5 Assemble the flare connections on the cut pipe ends.

Outer diameter (D)	Depth (A)	Flare dimension (L)
1/4 inch (0.35 mm)	0.051 inch (1.3 mm)	0.3425–0.3583 inch (8.7–9.1 mm)
3/8 inch (9.52 mm)	0.071 inch (1.8 mm)	0.5039–0.5197 inch (12.8–13.2 mm)
1/2 inch (12.70 mm)	0.079 inch (2.0 mm)	0.6378–0.6535 inch (16.2–16.6 mm)
5/8 inch (15.88 mm)	0.087 inch (2.2 mm)	0.7598–0.7756 inch (19.3–19.7 mm)

- 6 Remove the cover panel on the unit.

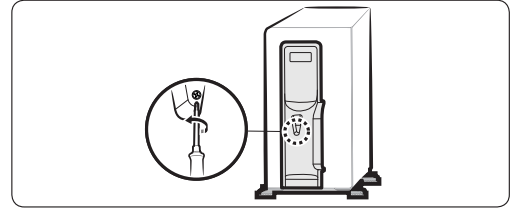

- 7 Remove the service valve caps.

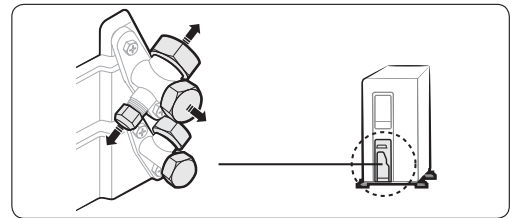

- 8 Connect the pipes to the service valve with the flare nuts. Hand-tighten the nuts to prevent stripping.

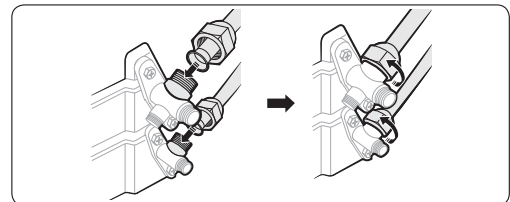

- 9 Torque the flare connections to the values in Step 2-3, step 7 on page 16.

- 10 Connect the power cables and secure with a cable clamp.

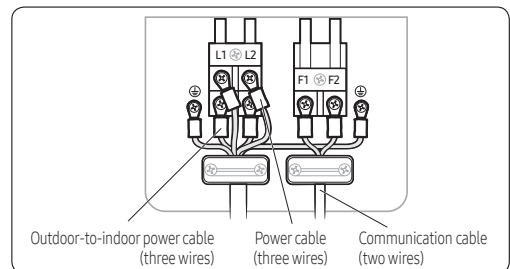

- 11 Connect the outdoor unit power supply cable to the preinstalled disconnect switch.

- 12 Leave the cover panel off for testing later in the installation process.

Installation Inspection and Testing

Step 4-1 Performing a drain leak test

- 1 Pour water into the drain pan.

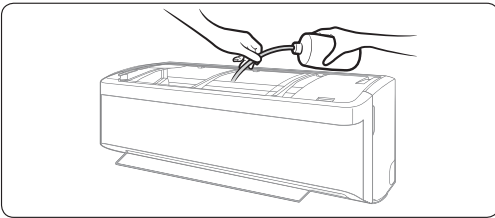

CAUTION

- Make sure that the water does not overflow onto the electrical connection.
- 2 Check for leaks at the drain connection under the cover panel.

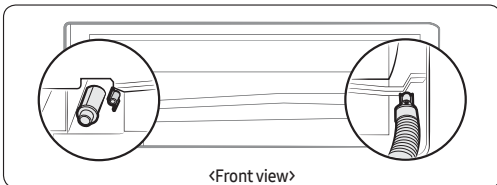

- 3 Make sure that the hose is draining properly at the outdoor unit.

Step 4-2 Performing pressure tests using nitrogen

- 1 Install the red high-side hose of an R-410A-gauge manifold set to the larger liquid/vapor line's service port.
- 2 Attach a pressure regulator to a tank of dry nitrogen.
- 3 Connect the common hose of the gauge manifold set to the pressure regulator's hose connection.
- 4 Open the service port to connect the line set to the gauge manifold set.
- 5 Pressurize the line set and indoor unit with dry nitrogen to 200 psig (adjust at the pressure regulator).
- 6 Using a soap-bubble solution suitable for refrigeration systems, check the four flare connections for leaks.

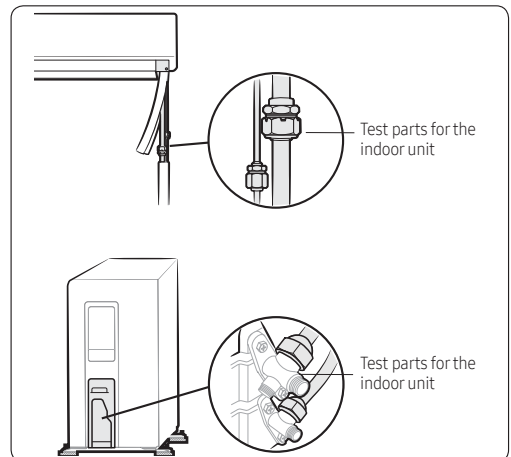

- 7 Wait 10 minutes to make sure that the pressure does not drop.
- 8 Increase the pressure to 400 psig and repeat steps 6 and 7.
- 9 Increase the pressure to 600 psig and repeat steps 6 and 7.
- 10 A drop in pressure during steps 7 through 9 indicates a system leak in the refrigeration line set or indoor unit. Perform a thorough leak check, repair the leak(s), and then repeat this procedure.
- 11 Close the gauge manifold, shut off the nitrogen tank, and remove the common hose to the pressure regulator.
- 12 Vent the nitrogen in lines to the atmosphere to prepare for system evacuation.

Step 4-3 Evacuating the system

CAUTION

- Because the system does not have filter driers, you must perform this triple evacuation procedure to remove all noncondensables and moisture from the system before charging. Failure to do so will result in reduced performance and shorter equipment life.

The time required to perform each evacuation will depend on the capacity (CFM) of the vacuum pump used.

- Install a micron vacuum gauge to the larger liquid/vapor line's service port on the branch of a tee.
- Install the red high-side hose of an R-410A gauge manifold set to the smaller liquid/vapor line's service port on the run of the tee.
- Attach a vacuum pump to the common hose of the manifold set.
- To ensure optimal performance, verify that the vacuum pump's oil has been changed recently.
- With the service port closed and the manifold gauge open, start the vacuum pump and make sure that the vacuum level drops below 4000 microns (as read on the micron gauge). If it is difficult to achieve a proper vacuum, a leak in the hoses is likely. Repair the leak(s) and/or check performance of vacuum pump, then repeat this step.
- Open the service port to connect the system to the manifold.
- Evacuate until 4000 microns is achieved, for at least 10 minutes.
- Close the gauge manifold valve, shut off the vacuum pump, and remove the common hose.
- Connect the hose to the nitrogen pressure regulator and bleed the hose by opening the end of the common hose closest to the manifold.
- Open the high-pressure manifold valve and slowly bring the system pressure to atmosphere (0 psig).
- Close the manifold and nitrogen cylinder and remove the common hose.
- Reconnect the common hose to the vacuum pump. Repeat steps 6 through 12, alternating between breaking the vacuum with dry nitrogen and evacuating, until system evacuation has occurred three times, to the following vacuum levels:

Evacuation	Microns
First	4000
Second	2000
Third	500

- After evacuating to at least 500 microns for the third time, close the gauge manifold valve and wait 10 minutes, making sure that the vacuum level in the system does not decrease. If it does, a small leak is likely. Repair the leak and repeat the evacuation process.

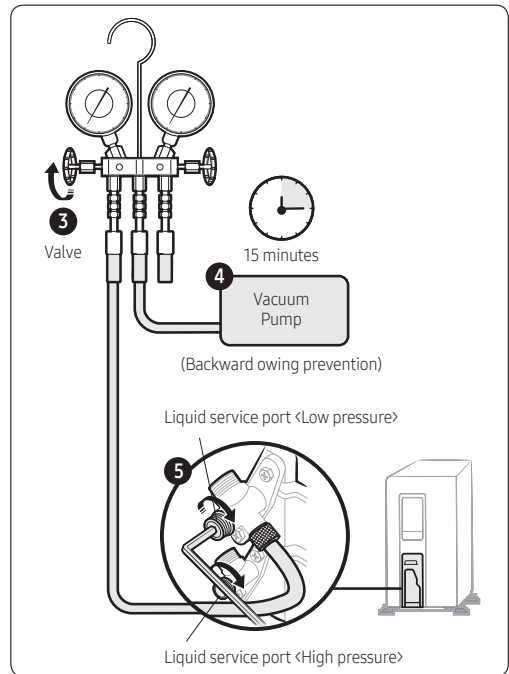

Installation Inspection and Testing

Step 4-4 Adding refrigerant (if needed)

The outdoor unit is charged with sufficient R-410A refrigerant to support up to a 24.6-ft line set. For lengths greater than 24.6 ft, you must add 0.16 oz of refrigerant per foot of additional length, after the lines are evacuated.



- 1 Calculate the additional refrigerant required:
Additional ounces of R-410A = (Total line set feet – 24.6) × 0.16
- 2 Connect the common hose of the manifold gauge set to the inverted R-410A refrigerant cylinder.
- 3 Place the refrigerant cylinder on a scale set to measure ounces.
- 4 Open the valve on the tank.
- 5 At the manifold connection, bleed the refrigerant to remove any air that may be present in the common hose.
- 6 Open the gauge manifold and charge the system with the amount of refrigerant calculated in step 1.
- 7 Close the gauge manifold valve, close the valve on the refrigerant tank, and remove the common hose.



Step 4-5 Preparing the system for commissioning

- 1 Wrap the remaining refrigerant pipe lengths and connection points with foam insulation.
- 2 Wrap the unwrapped portions of the piping bundle with vinyl tape.
- 3 With the manifold gauge set still installed, open the isolation valves on the outdoor unit to connect the outdoor unit to the line set and indoor unit.
- 4 Remove the manifold set and vacuum gage.

Step 4-6 Commissioning the unit

The unit is commissioned using the Smart Install feature. Smart Install can be started only with the remote control. While Smart Install is running, you cannot operate the remote control.

- 1 Make sure that the air conditioner is in standby status (powered up with the controller in off mode).
- 2 Install batteries in the remote control.
- 3 Hold down the  (Power),  (Mode), and  (SET) buttons on the remote control simultaneously for 4 seconds.
- 4 Wait until Smart Install succeeds or fails (approximately 7 to 13 minutes).
 - While Smart Install is running:

Type	 Display
Indoor unit indicator	
	The progress is displayed as a number between 0 and 99 on the indoor unit display.

- When Smart Install succeeds: Smart Install ends with a ringing sound, and the air conditioner returns to standby status.
- When Smart Install fails: An error message is displayed on the indoor unit display, and Smart Install ends. To correct the problem, see the error table on page 25.



Error indicator	Error	Measures for the installer to take
88 Display		
[10 1	Communication error between indoor and outdoor units	<ul style="list-style-type: none"> Check the cables between the indoor and outdoor units. See if the power cable or communication cable is crossed.
[12 1	Error on indoor temperature sensor	<ul style="list-style-type: none"> Make sure that the indoor temperature sensor is properly connected.
[122 [123	Error on indoor heat exchanger	<ul style="list-style-type: none"> Make sure that the evaporator temperature sensor is properly connected.
[154	Error on indoor fan motor	<ul style="list-style-type: none"> Make sure that the evaporator motor is properly connected to the board. Check for a foreign substance inside the unit that may be preventing the blower wheel from turning.
88 [162 [163	EEPROM/Option error	<ul style="list-style-type: none"> Reset the option codes.
[422	Refrigerant flow blocking error	<ul style="list-style-type: none"> Make sure that the service valves are completely open. Check for any blockage in the refrigerant pipe that connects the indoor and outdoor units. Check for refrigerant leaks.
[554	Lack of refrigerant (for inverter models only)	<ul style="list-style-type: none"> Make sure a sufficient amount of refrigerant has been added for a pipe that is longer than 24.60ft (7.5 m). Check for refrigerant leaks between the valve and pipe connection.

Step 4-7 Performing final checks and trial operation



WARNING

Stop the unit, disconnect the power, and contact Samsung technical support if any of the following occurs:

- The unit produces a burning smell or smoke.
- The power cable is hot or damaged.
- The unit is very noisy.
- Any foreign substance, such as water, has entered the appliance.
- The appliance becomes flooded.

- Check the following:
 - Strength of the installation site
 - Tightness of pipe connection to detect gas leak
 - Electric wiring connection
 - Heat-resistant insulation of the pipe
 - Drainage
 - Grounding conductor connection
 - Correct operation (Take the following steps.)
- Press the  (Power) button on the remote control to check the following:
 - The indicator on the indoor unit lights up.
 - The airflow blade opens and the fan gears up for operation.
- Press the  (Mode) button to select Cool or Heat mode. Then take the following sub-steps:
 - In Cool mode, use the Temperature button to set the set temperature to 61 °F (16 °C)

Installation Inspection and Testing



- In Heat mode, use the Temperature button to set the set temperature to 86 °F (30 °C)
 - Check whether, approximately 3 to 5 minutes later, the outdoor unit starts, and a cool or warm air blows out.
 - After 12 minutes of stationary condition, check the indoor unit air treatment.
- 4 Press the  (Air swing) button to check whether the airflow blades work properly.
 - 5 Press the  (Power) button to stop the trial operation.

Pumping down for removing the product

Pump-down is an operation intended to collect all the system refrigerant in the outdoor unit. This operation must be carried out before disconnecting the refrigerant tubing in order to avoid refrigerant loss to the atmosphere.

WARNING

- After installing the product, be sure to perform leak tests on the piping connections. After pumping down refrigerant to inspect or relocate the outdoor unit, be sure to stop the compressor and then remove the connected pipes.
 - Do not operate the compressor while a valve is open due to refrigerant leakage from a pipe or an unconnected or incorrectly connected pipe. Failure to do so may cause air to flow into the compressor and too a high pressure to develop inside the refrigerant circuit, leading to an explosion or product malfunction.

- 1 Hold down the  (Power) button on the indoor unit for 5 seconds. Beep sounds immediately to indicate that the product is ready for pump down procedure.
- 2 Let the compressor run for more than 5 minutes.
- 3 Release the valve caps on High and Low pressure side.
- 4 Use L-wrench to close the valve on the high pressure side.
- 5 After approximately 1 minute, close the valve on the low pressure side.
- 6 Stop operation of the air conditioner by pressing the  (Power) button on the indoor unit or remote control.
- 7 Disconnect the pipes.

CAUTION

- Compressor damage may occur if the compressor is run at a negative suction pressure.

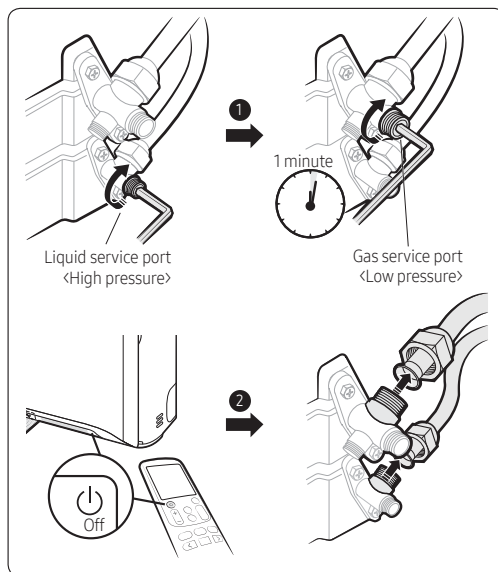

Setting the installation options

Setting the installation options

This product has the installation options depending on the user's installation environment. Even after the product ships, it is possible to input option changes to the indoor unit using the transmission packet of the remote control.

This chapter provides a method for setting the installation options.

STEP1. Common steps for setting the options

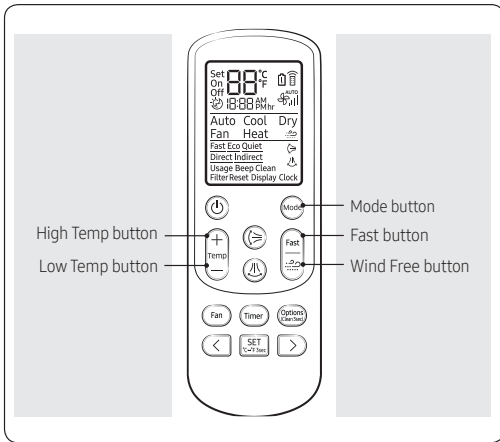

NOTE

- The remote control display and buttons may vary depending on the model.

- Enter the mode for setting the options:
 - Remove the batteries from the remote control, and then insert them again.
 - While holding down the \oplus (High Temp) and \ominus (Low Temp) buttons simultaneously, insert the batteries into the remote control.
 - Make sure that you are entered to the mode for setting the options:
- Set the option values

CAUTION













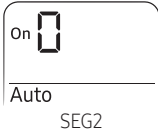
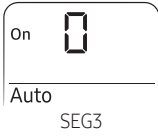

- The total number of available options are 24: SEG1 to SEG24.
- Because SEG1, SEG7, SEG13, and SEG19 are the page options used by the previous remote control models, the modes to set values for these options are skipped automatically.
- Set a 2-digit value for each option pair in the following order: SEG2 and SEG3 → SEG4 and SEG5 → SEG6 and SEG8 → SEG9 and SEG10 → SEG11 and SEG12 → SEG14 and SEG15 → SEG16 and SEG17 → SEG18 and SEG20 → SEG21 and SEG22 → SEG23 and SEG24





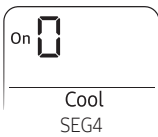
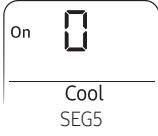

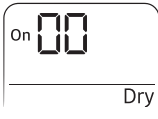

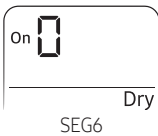
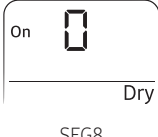







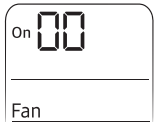







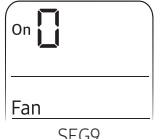

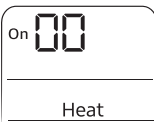
SEG1	SEG2	SEG3	SEG4	SEG5	SEG6
0	X	X	X	X	X
SEG7	SEG8	SEG9	SEG10	SEG11	SEG12
1	X	X	X	X	X
SEG13	SEG14	SEG15	SEG16	SEG17	SEG18
2	X	X	X	X	X
SEG19	SEG20	SEG21	SEG22	SEG23	SEG24
3	X	X	X	X	X

On (SEG1 to SEG12)	Off (SEG13 to SEG24)





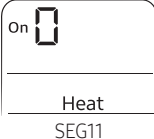
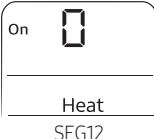

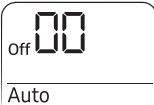











Setting the installation options



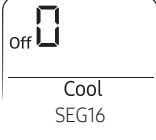
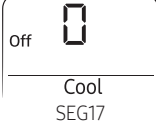

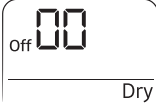



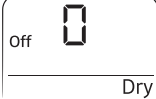

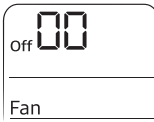

Take the steps presented in the following table:

Steps	Remote control display
<p>1 Set the SEG2 and SEG3 values:</p> <p>a Set the SEG2 value by pressing the  (Wind Free) button repeatedly until the value you want to set appears on the remote control display.</p> <p>b Set the SEG3 value by pressing the  (Fast) button repeatedly until the value you want to set appears on the remote control display.</p> <p>When you press the  (Wind Free) or  (Fast) button, values appear in the following order: 0 → 1 → ... → E → F</p>	 
<p>2 Press the  (Mode) button. Cool and On appear on the remote control display.</p>	
<p>3 Set the SEG4 and SEG5 values:</p> <p>a Set the SEG4 value by pressing the  (Wind Free) button repeatedly until the value you want to set appears on the remote control display.</p> <p>b Set the SEG5 value by pressing the  (Fast) button repeatedly until the value you want to set appears on the remote control display.</p> <p>When you press the  (Wind Free) or  (Fast) button, values appear in the following order: 0 → 1 → ... → E → F</p>	 
<p>4 Press the  (Mode) button. Dry and On appear on the remote control display.</p>	
<p>5 Set the SEG6 and SEG8 values:</p> <p>a Set the SEG6 value by pressing the  (Wind Free) button repeatedly until the value you want to set appears on the remote control display.</p> <p>b Set the SEG8 value by pressing the  (Fast) button repeatedly until the value you want to set appears on the remote control display.</p>	 

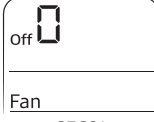
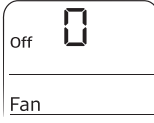
Steps	Remote control display
<p>When you press the  (Wind Free) or  (Fast) button, values appear in the following order:  →  → ... →  → </p>	
<p>6 Press the  (Mode) button. Fan and On appear on the remote control display.</p>	
<p>7 Set the SEG9 and SEG10 values:</p> <p>a Set the SEG9 value by pressing the  (Wind Free) button repeatedly until the value you want to set appears on the remote control display.</p> <p>b Set the SEG10 value by pressing the  (Fast) button repeatedly until the value you want to set appears on the remote control display.</p> <p>When you press the  (Wind Free) or  (Fast) button, values appear in the following order:  →  → ... →  → </p>	 
<p>8 Press the  (Mode) button. Heat and On appear on the remote control display.</p>	
<p>9 Set the SEG11 and SEG12 values:</p> <p>a Set the SEG11 value by pressing the  (Wind Free) button repeatedly until the value you want to set appears on the remote control display.</p> <p>b Set the SEG12 value by pressing the  (Fast) button repeatedly until the value you want to set appears on the remote control display.</p> <p>When you press the  (Wind Free) or  (Fast) button, values appear in the following order:  →  → ... →  → </p>	 
<p>10 Press the  (Mode) button. Auto and Off appear on the remote control display.</p>	

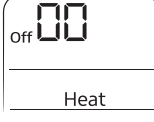
Setting the installation options

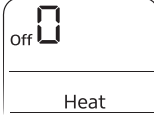
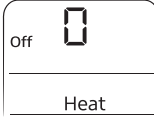

Steps	Remote control display
<p>11 Set the SEG14 and SEG15 values:</p> <p>a Set the SEG14 value by pressing the  (Wind Free) button repeatedly until the value you want to set appears on the remote control display.</p> <p>b Set the SEG15 value by pressing the  (Fast) button repeatedly until the value you want to set appears on the remote control display.</p> <p>When you press the  (Wind Free) or  (Fast) button, values appear in the following order: 0 • 1 • ... • E • F</p>	 
<p>12 Press the  (Mode) button. Cool and Off appear on the remote control display.</p>	
<p>13 Set the SEG16 and SEG17 values:</p> <p>a Set the SEG16 value by pressing the  (Wind Free) button repeatedly until the value you want to set appears on the remote control display.</p> <p>b Set the SEG17 value by pressing the  (Fast) button repeatedly until the value you want to set appears on the remote control display.</p> <p>When you press the  (Wind Free) or  (Fast) button, values appear in the following order: 0 • 1 • ... • E • F</p>	 
<p>14 Press the  (Mode) button. Dry and Off appear on the remote control display.</p>	
<p>15 Set the SEG18 and SEG20 values:</p> <p>a Set the SEG18 value by pressing the  (Wind Free) button repeatedly until the value you want to set appears on the remote control display.</p> <p>b Set the SEG20 value by pressing the  (Fast) button repeatedly until the value you want to set appears on the remote control display.</p>	 

Steps	Remote control display
<p>When you press the  (Wind Free) or  (Fast) button, values appear in the following order: 0 → 1 → ... E → F</p>	<p>SEG20</p>
<p>16 Press the  (Mode) button. Fan and Off appear on the remote control display.</p>	
<p>17 Set the SEG21 and SEG22 values:</p> <p>a Set the SEG21 value by pressing the  (Wind Free) button repeatedly until the value you want to set appears on the remote control display.</p> <p>b Set the SEG22 value by pressing the  (Fast) button repeatedly until the value you want to set appears on the remote control display.</p> <p>When you press the  (Wind Free) or  (Fast) button, values appear in the following order: 0 → 1 → ... E → F</p>	 
<p>18 Press the  (Mode) button. Heat and Off appear on the remote control display.</p>	
<p>19 Set the SEG23 and SEG24 values:</p> <p>a Set the SEG23 value by pressing the  (Wind Free) button repeatedly until the value you want to set appears on the remote control display.</p> <p>b Set the SEG24 value by pressing the  (Fast) button repeatedly until the value you want to set appears on the remote control display.</p> <p>When you press the  (Wind Free) or  (Fast) button, values appear in the following order: 0 → 1 → ... E → F</p>	 

Setting the installation options

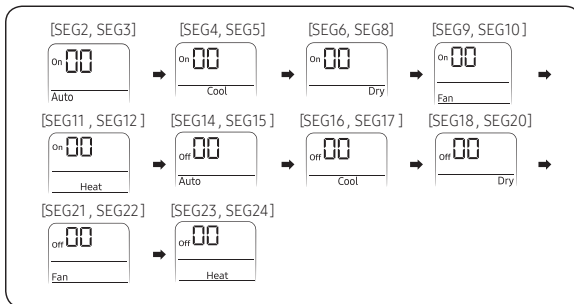
- 3 Check whether the option values that you have set are correct by pressing the  (Mode) button repeatedly



- 4 Save the option values into the indoor unit:
Point the remote control to the remote control sensor on the indoor unit and then press the  (Power) button on the remote control twice. Make sure that this command is received by the indoor unit. When it is successfully received, you can hear a short sound from the indoor unit. If the command is not received, press the  (Power) button again.

STEP 2. Setting the installation options in a batch

Installation option no. for an indoor unit : 02XXXX-1XXXXX-2XXXXX-3XXXXX

The installation option can be set at the factory differently depending on the function of each model.

Various option items of each address assigned within the installation option are shown in the following table.

- Among the values expressed in each address, "Reserved" cannot be changed because it means no options are allocated or a unique function for the model is already assigned. The options SEG4, SEG5, SEG8, SEG14, SEG15, SEG17, SEG18, and SEG20 can be changed to reflect the present installation conditions, if needed.
 - Before changing the options, make sure that the power is supplied to the indoor unit. If the indoor unit is not plugged in, it must include a power supply so that the remote control's option transmission packet can be input to the indoor unit.
 - When changing the options according to the installation environment, there are two methods: changing 24 digits in a batch and changing the options individually.
 - To change in a batch, you must first know the entire 24-digit installation options of the model from the service manual. Set the installation options of indoor units by following the steps in STEP1. Common steps for setting the options on page 27 after determining the specific address segment values required to change the installation options.
 - If you do not know the entire installation options, refer to the following section STEP 3. Changing the options individually on page 35.
 - Description of option segments with changeable values

① SEG4 : set for using "Indoor external temperature sensor" or "fan Thermo off control"
(Fan thermo off control only: 1, external sensor only: 6, using both: 7)



CAUTION

- "Fan Thermo Off control" is only available for an indoor unit for Free Joint Multi.
When "Fan Thermo Off control" is matched with a Single Zone High-Wall system, the setting cannot be made using this option. But you can set this option by referring to the following section STEP 3. Changing the options individually on page 35.
- ② SEG5 : To use the central controller, enter 1.
- ③ SEG8 : To use the external drain pump, enter 8.



NOTE

- If the SEG8 is set to 'Use', the SEG14-External Contact Control will be set to DISABLE automatically.
- ④ SEG14 : As an External Contact Control option, check the installation site and then select the appropriate option.



NOTE

- If SEG14 is not set to 'default', SEG8-the external drain pump will not be available.
- ⑤ SEG15 : Set an output option according to external control (Thermo on - 0, Operation on - 1)
- ⑥ SEG17 : Control the received sound tone of the remote control of the indoor unit. (Buzzer use - 0, disuse - 1)
- ⑦ SEG18 : Change the filter usage time of the indoor unit (500HR - 1, 1000HR - 2)
- ⑧ SEG20 : Set this option to control an indoor unit using a specific remote control.

Setting the installation options

Option	SEG1		SEG2			SEG3			SEG4			SEG5			SEG6							
Function	Page		Mode			Reserved			Use of external room temperature sensor / Fan Thermo Off control			Use of central control			Reserved							
Indication and details	Indication	Details	Indication	Details	-				Indication	Details	Factory set	Indication	Details	Factory set								
	0	2	Installation	-	0				1	Disuse	0	0	Disuse	1								
																		6	Disuse/Use	1	use	1
Option	SEG7		SEG8			SEG9			SEG10			SEG11			SEG12							
Function	Page		Use of drain pump			Reserved			Reserved			Reserved			Reserved							
Indication and details	Indication	Details	Indication	Details	Factory set																	
	1	8	Use external drain pump	0	Disuse	0																
Option	SEG13		SEG14			SEG15			SEG16			SEG17			SEG18							
Function	Page		Use of external control			Setting the output of external control			Reserved			Buzzer control (Receiving tone of indoor unit)			Use Time of Filter							
Indication and details	Indication	Details	Indication	Details	Factory set	Indication	Details	Factory set				Indication	Details	Factory set	Indication	Details	Factory set					
	2		0	Disuse	0	0	Thermo on	0				0	Use	0	0	Disuse	1					
			1	On/Off control		1	Operation on					1	500HR									
			2	Off control		-	-					2	1000HR									
			3	Window On/Off control		-	-					-	-									
			8	Reverse control		-	-					-	-									
			9	On/off & Reverse control		-	-					-	-									
			A	Off & Reverse control		-	-		-	-												
B	Window on/off & Reverse control	-	-	-	-																	
Option	SEG19		SEG20			SEG21			SEG22			SEG23			SEG24							
Function	Page		Wireless controller address			Reserved			Reserved			Reserved			Reserved							
Indication and details	Indication	Details	Indication	Details	Factory set																	
	3		0 or 1	Indoor1	0																	
			2	Indoor2																		
			3	Indoor3																		
4			Indoor4																			

STEP 3. Changing the options individually

When you want to change the value of a specific option, refer to the following table and follow the steps in STEP1. Common steps for setting the options on page 27.

(Enter the set address of the installation option to change in SEG4 and SEG5 in the table below, enter the change option value in SEG6. The values of SEG1, SEG2, SEG3, and SEG4 are always 0, D, 2 in the same order as in the following table.)

Option	SEG1		SEG2		SEG3		SEG4		SEG5		SEG6	
Function	Page		Mode		Option mode to change		Tens position of the option number		Units position of the option number		New value	
Indication and details	Indication	Details	Indication	Details	Indication	Details	Indication	Details	Indication	Details	Indication	Details
		0		D		2		Tens position value	0 to 9	Units position value	0 to 9	New value

Example: Changing the Buzzer control (SEG17) option of the installation options to 1 (disuse).

Option	SEG1		SEG2		SEG3		SEG4		SEG5		SEG6	
Function	Page		Mode		Option mode to change		Tens position of the option number		Units position of the option number		New value	
Indication	0		D		2		1		7		1	

NOTE

- How to set the thermo off option for a Single Zone High-Wall system is shown in the following option table:

Option	SEG1		SEG2		SEG3		SEG4		SEG5		SEG6	
Function	Page		Mode		Option mode to change		Tens position of the option number		Units position of the option number		New value	
Indication	0		D		1		2		4		F	

Sub PCB installation(optional)

(Wired remote controller, central remote controller etc.)

- 1 Turn the power off and take off the cover panel of the indoor unit.

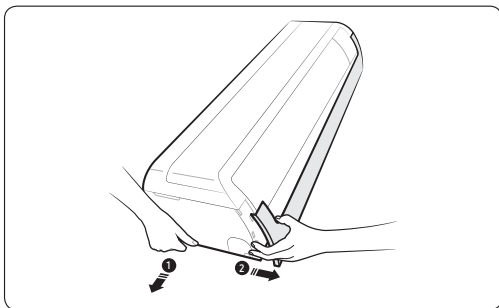

- 2 Attach the Sub PCB to the Case Sub PCB.
- 3 Assemble the Case Sub PCB to the indoor unit.

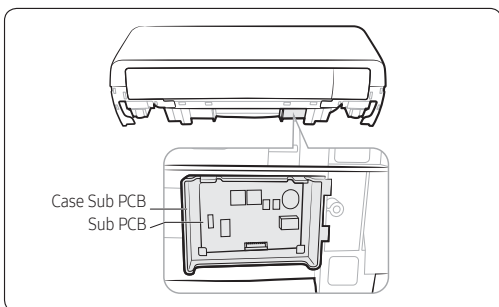

- 4 Find the PCB wire, and connect the wire to the Sub PCB as seen in the picture.

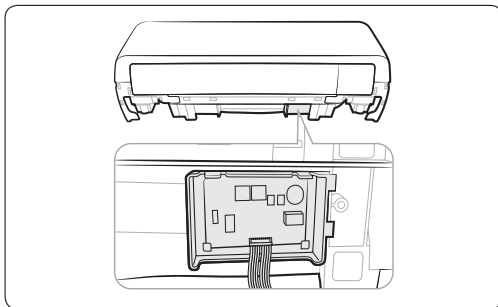

- 5 Connect the wire(remote controller, central remote controller etc) to the Sub PCB.
- 6 Assemble the Cover PCB and the front panel.
※ If the Sub PCB is not installed, arrange the wire for multi system (connection) as shown in the illustration.

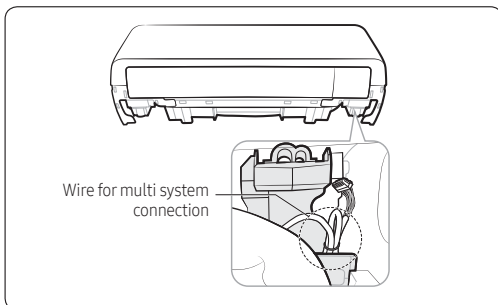

NOTE

- The Sub PCB is attached to be controlled by the wired remote controller and central controller.

SAMSUNG