

# SAMSUNG

## SYSTEM AIR CONDITIONER

SINGLE for North America(R-410A, Heat Pump and Cooling Only)

### INDOOR UNIT

AC009BNLDCH AC030BN4DCH  
AC012BNLDCH AC036BN4DCH  
AC018BNLDCH AC042BN4DCH  
AC009BNHDCH AC048BN4DCH  
AC012BNHDCH AC018BN6DCH  
AC018BNHDCH AC024BN6DCH  
AC024BNHDCH AC030BN6DCH  
AC030BNHDCH AC036BN6DCH  
AC036BNHDCH AC042BN6DCH  
AC042BNHDCH AC048BN6DCH  
AC048BNHDCH AC018BNADCH  
AC009BN1DCH AC024BNADCH  
AC012BN1DCH AC030BNTDCH  
AC018BN1DCH AC036BNTDCH  
AC009BNNDCH AC009BNJDCH  
AC012BNNDCH AC012BNJDCH  
AC018BNNDCH AC018BNJDCH  
AC018BN4DCH AC018BNZDCH  
AC024BN4DCH AC024BNZDCH

### OUTDOOR UNIT

AC009BXADCH  
AC012BXADCH  
AC018BXADCH  
AC024BXADCH  
AC030BXADCH  
AC036BXADCH  
AC042BXADCH  
AC048BXADCH  
AC018BXSCCC  
AC024BXSCCC  
AC030BXSCCC  
AC036BXSCCC  
AC030BXSCCH  
AC036BXSCCH

# SERVICE *Manual*

## AIR CONDITIONER



## CONTENTS

1. Precautions
2. Product Specifications
3. Disassembly and Reassembly
4. Troubleshooting
5. PCB Diagram and Parts List
6. Wiring Diagram
7. Reference Sheet

# Contents

<b>1. Precautions.....</b>	<b>1-1</b>
1-1. Precautions for the Service.....	1-1
1-2. Precautions for the Static Electricity and PL.....	1-1
1-3. Precautions for the Safety.....	1-1
1-4. Precautions for Handling Refrigerant for Air Conditioner.....	1-2
1-5. Precautions for Welding the Air Conditioner Pipe.....	1-2
1-6. Precautions for Additional Supplement of Air Conditioner Refrigerant.....	1-2
1-7. Other Precautions.....	1-2
<b>2. Product Specifications.....</b>	<b>2-1</b>
2-1. CAC Single.....	2-1
2-2. The Feature of Product.....	2-2
2-2-1. Features (Wind-Free 1Way CST).....	2-2
2-3. The Feature of Product.....	2-3
2-3-1. Features (Wind-Free 4Way CST).....	2-3
2-4. Features & Benefits.....	2-8
2-4-1. 4Way Cassette (600 x 600).....	2-8
2-4-2. 4Way Cassette (600 x 600) - Tasteful design, Compact, Lightweight build.....	2-8
2-4-3. 360 Cassette.....	2-10
2-4-4. Duct S.....	2-12
2-4-5. Wall Mount Type.....	2-13
2-4-6. Wall Mounted Wind Free - Wind Free, Auto Clean.....	2-14
2-5. Product Specifications.....	2-15
2-6. Specifications of optional items.....	2-40
2-6-1. Accessories.....	2-40
<b>3. Disassembly and Reassembly.....</b>	<b>3-1</b>
3-1. Indoor unit.....	3-2
3-2. Outdoor unit.....	3-85
<b>4. Troubleshooting.....</b>	<b>4-1</b>
4-1. Setting an indoor unit address and installation option.....	4-1
4-1-1. The procedure of setting option.....	4-1
4-1-2. The procedure of setting option.....	4-2
4-1-3. Order for Setting Options (Wired Remote Controller).....	4-10
4-1-4. Setting the indoor unit addresses.....	4-11
4-1-5. Setting an indoor unit installation option (Suitable for the condition of each installation location).....	4-12
4-1-6. Changing the addresses and options individually.....	4-32
4-1-7. Emergency Temperature Output (ETO) function.....	4-33
4-2. Model-specific option code.....	4-35
4-3. Diagnostic Checklist.....	4-41
4-3-1. Test operation mode and check mode.....	4-41
4-3-2. Error code [indoor].....	4-47
4-4. Troubleshooting by symptoms.....	4-56
4-4-1. Indoor temperature sensor error (E121).....	4-56
4-4-2. Indoor heat exchanger temperature sensor error (E122).....	4-57
4-4-3. Indoor unit float sensor error (E153).....	4-58
4-4-4. Indoor Fan error (E154).....	4-59
4-4-5. EEPROM circuit failure (E162).....	4-60
4-4-6. Communication error after finishing Tracking (E202).....	4-61
4-4-7. The whistling noise from the indoor unit in low wind mode.....	4-62

# Contents

4-4-8. When the outdoor unit power is not ON - Initial Diagnosis : 1-phase products .....	4-63
4-4-9. Indoor/outdoor communication error (2min.) (Error Code : E202) .....	4-65
4-4-10. Communication error between outdoor unit INV ↔ MAIN MICOM (1 min.) (Error Code: E203).....	4-67
4-4-11. Outdoor sensor error(Error Code : E221, E231, E251, E320) .....	4-68
4-4-12. Compressor down due to freezing control (Error Code : E403).....	4-69
4-4-13. Pipe blockage error (Error Code : E422).....	4-70
4-4-14. Outdoor unit Fan error (Error Code : E458, E475) .....	4-71
4-4-15. Compressor starting error / rotation error (Error Code : E461, E467) .....	4-72
4-4-16. Full current error / PFC over-current error (Error Code : E462, E484).....	4-74
4-4-17. IPM (Over Current) error (Error Code : E464).....	4-75
4-4-18. DC LINK over-current / low-voltage error (Error Code : E466) H/W DC_Link Over Voltage Error (Error Code : E483) AC Input Voltage Sensor Error (Error Code : E488).....	4-78
4-4-19. Gas leakage error (Error Code : E554).....	4-80
4-4-20. Others.....	4-82
<b>5. PCB Diagram and Parts List.....</b>	<b>5-1</b>
5-1. Indoor Unit Main PBA .....	5-1
5-2. Indoor Unit Display PBA .....	5-19
5-3. Indoor Unit Sub PBA .....	5-25
5-4. Outdoor Unit Main PBA .....	5-27
5-5. Outdoor Unit Inverter PBA.....	5-31
5-6. Outdoor Unit EMI PBA.....	5-36
<b>6. Wiring Diagram.....</b>	<b>6-1</b>
6-1. Indoor Unit.....	6-1
6-2. Outdoor unit.....	6-9
<b>7. Reference Sheet .....</b>	<b>7-1</b>
7-1. Index for Model Name .....	7-1
7-1-1. Indoor Unit.....	7-1
7-1-2. Outdoor Unit.....	7-2
7-1-3. Panel .....	7-3
7-2. Refrigerating Cycle Diagram .....	7-4

---

# 1. Precautions

---

## 1-1. Precautions for the Service

---

- **Use the correct parts when changing the electric parts.**
  - Please check the labels and notices for the model name, proper voltage, and proper current for the electric parts.
- **Fully repair the connection for the types of harness when repairing the product after breakdown.**
  - A faulty connection can cause irregular noise and problems.
- **When disassembling or assembling, make sure that the product is laid down on a work cloth.**
  - Doing so will prevent scratching to the exterior of the rear side of the product.
- **Completely remove dust or foreign substances on the housing, connection, and inspection parts when performing repairs.**
  - This can prevent fire hazards for tracking, short, etc.
- **Please tighten the service valve of the outdoor unit and the valve cap of the charging valve as securely as possible by using a monkey spanner.**
- **Check whether the parts are properly and securely assembled after performing repairs.**
  - These parts should be in the same condition as before the repair.

## 1-2. Precautions for the Static Electricity and PL

---

- **Please carefully handle the PCB power terminal during repair and measurement when it is turned on since it is vulnerable to static electricity.**
  - Please wear insulation gloves before performing PCB repair and measurement.
- **Check if the place of installation is at least 2m away from electronic appliances such as TV, video players, and stereos.**
  - This can cause irregular noise or degrade the picture quality.
- **Please make sure the customer does not directly repair the product.**
  - Arbitrary dismantling may result in electric shock or fire.

## 1-3. Precautions for the Safety

---

- **Do not pull or touch the power plug or the subsidiary power switch with wet hands.**
  - This may result in electric shock or fire.
- **If the power line or the power plug is damaged, then it must be changed since this is a hazard.**
- **Do not bend the wire too much or position it so that it can be damaged by a heavy object on top.**
  - This may result in electric shock or fire.
- **The use of multiple electric outlets should be prohibited.**
  - This may result in electric shock or fire.
- **Ground the connection if it is necessary.**
  - The connection must be grounded if there is any risk of electrical short due to water or moisture.
- **Unplug the power or turn off the subsidiary power switch when changing or repairing electrical parts.**
  - Doing so will prevent electric shock.
- **Explain to workers that the battery for the remote control needs to be separated for storage purposes when the product will not be used for a long time.**
  - This can cause a problem for the remote control since battery fluid may trickle out.

## 1-4. Precautions for Handling Refrigerant for Air Conditioner

---

### Environmental Cautions: Air pollution due to gas release

- **Safety Cautions**

If liquid gas is released, then body parts that come into contact with it may experience frostbite/blister/numbness.

If a large amount of gas is released, then suffocation may occur due to lack of oxygen. If the released gas is heated, then noxious gas may be produced by combustion.

- **Container Handling Cautions**

Do not subject container to physical shock or overheating. (Flowage is possible while moving within the regulated pressure.)

## 1-5. Precautions for Welding the Air Conditioner Pipe

---

- **Dangerous or flammable objects around the pipe must be removed before the welding.**

- **If the refrigerant is kept inside the product or the pipe, then remove the refrigerant prior to welding.**

If the welding is carried out while the refrigerant is kept inside, the welding cannot be properly performed. This will also produce noxious gas that is a health hazard. This leakage will also explode with the refrigerant and oil due to an increase in the refrigerant pressure, posing a danger to workers.

- **Please remove the oxide produced inside the pipe during the welding with nitrogen gas.**

Using another gas may cause harm to the product or others.

## 1-6. Precautions for Additional Supplement of Air Conditioner Refrigerant

---

- **Precisely calculate the refrigerant by using a scale and S-net, and proceed with the test operation.**

Excessive supplement can cause harm to the product since it can cause an inflow of the liquid refrigerant into the compressor.

- **Do not heat the refrigerant container for a forced injection.**

This may cause harm to the product or others since the refrigerant container may burst.

- **Do not operate the product after removing the product safety pressure switch and sensor.**

If the product is blocked inside, then this may cause harm to the product or others due to the excess pressure increase of the refrigerant gas.

## 1-7. Other Precautions

---

- **There should be no leakage of the pipes after installation. When withdrawing the refrigerant, the compressor should be stopped before removing the connecting pipe.**

**If the compressor is operating while the refrigerant pipe is not correctly connected and the service valve is opened, then air and other substances can enter the pipe. The interior of the refrigerant cycle may then build up excessive high pressure resulting in explosion and damage.**

- **If the Wall Mounted type(Wind free) indoor unit is included in the installation combination, please contact us before changing the Capacity correction for heating function to 33kg/cm2g during Outdoor unit key function setting.**

## 2. Product Specifications

### 2-1. CAC Single

#### ■ Stabilize the atmosphere with broad temperature allowance and control

Samsung is dedicated to supporting comfortable living and working environments based on the strength of its technologies. With a single unit, CAC Single delivers reliable comfort and control over multiple areas to ensure a pleasant atmosphere in any climate.

#### ■ Wide temperature performance

No matter how extreme the temperature, the highperforming CAC Single can handle the condition without the need for an additional unit. Featuring a wide temperature allowance, it can cool in heat of up to 50 and provide warmth in the freezing cold of -20°C to ensure a constant and comfortable home environment.

#### ■ Ideal comfort in minutes

The CAC Single digital inverter air conditioner works at maximum capacity at startup. As soon as the temperature reaches the desired or set temperature, CAC Single performs fine adjustments to cope with any changes. This means less temperature fluctuation and ideal comfort in a matter of minutes.

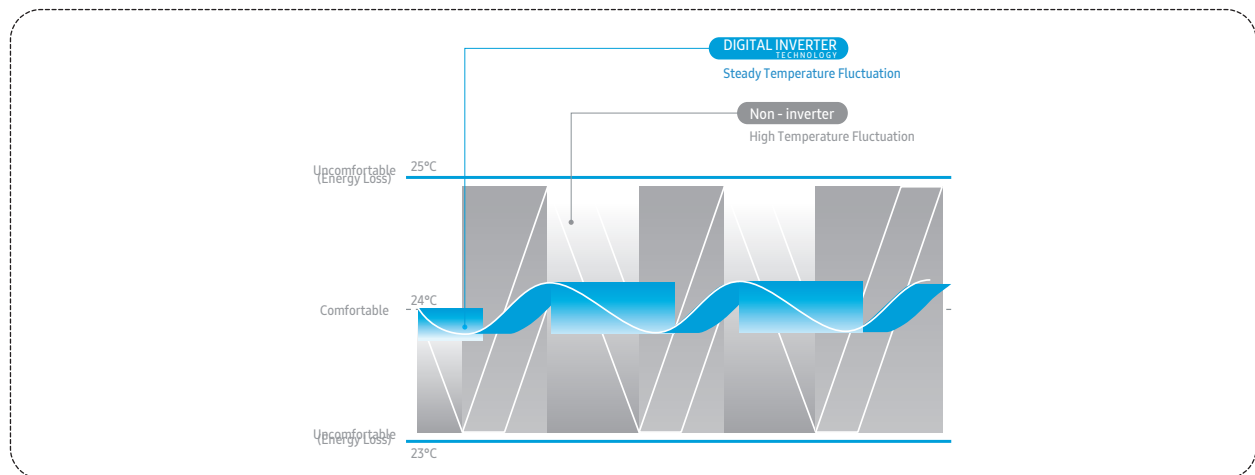

#### ■ Versatile piping installation

CAC Single outdoor units offer a selection of pipe directions. The internal pipe connection ports allow four different pipe directions, supporting a neater, more organized-looking unit upon installation.



## 2-2. The Feature of Product

### 2-2-1. Features (Wind-Free 1Way CST)

#### ■ Wind-Free cooling

Comfort wind implementation by Wind-Free cooling.

※ Wind-Free implementation : Still air by the velocity of flow below 0.15m/s.

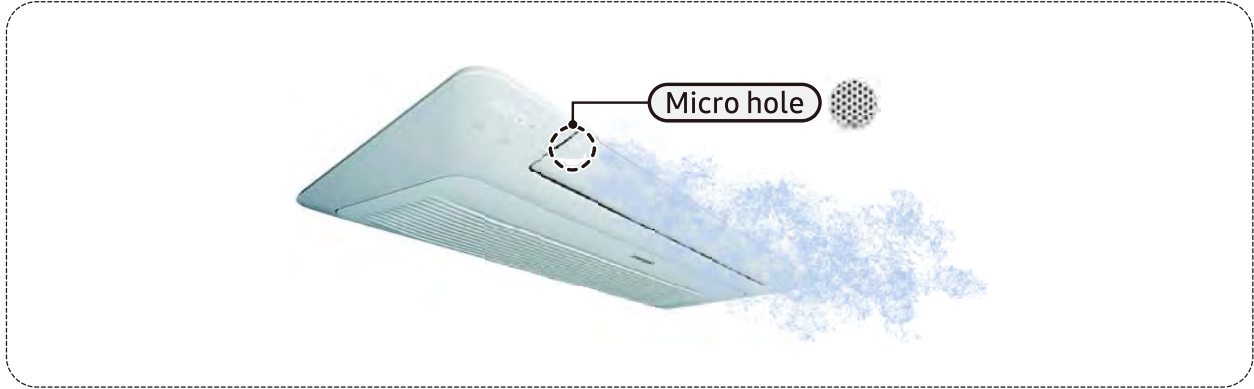

#### ■ Big blade

Max. 8m Horizontal reach

※ Blade enlargement about 47% compare to conventional product

※ Reach : 8m (Height 0.6m, Wind speed 0.3m/s) Conventional product (Samsung) : 5m

※ Based on Wind-Free 1Way 7.1kW

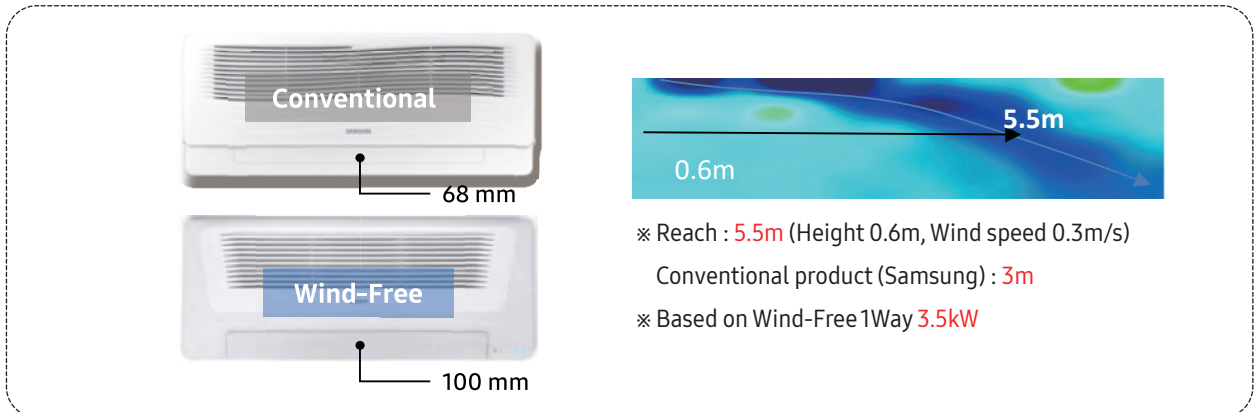

#### ■ Even cooling

Even cooling For spacious space

※ Expand the blade angle from 30° to 80°

Conventional product (Samsung) : 40~80°

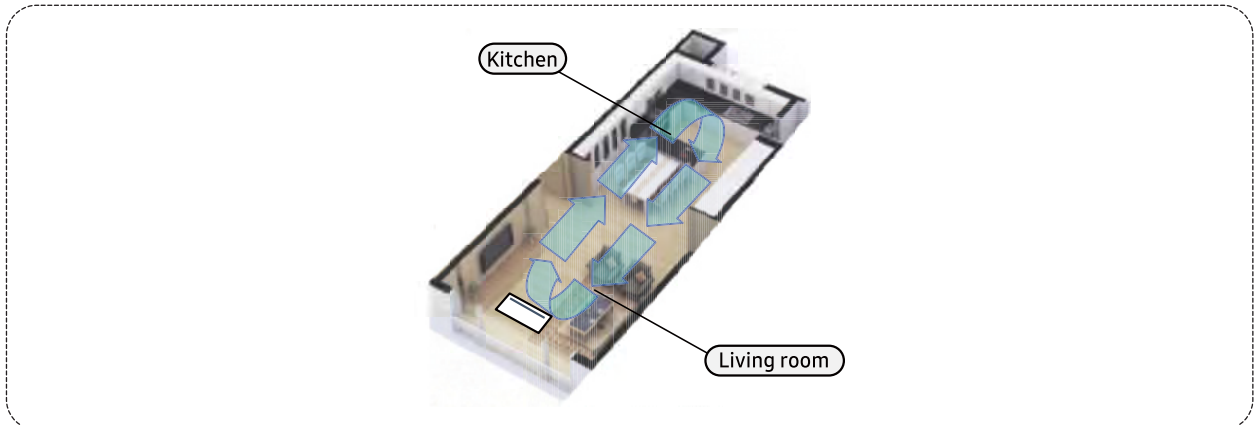

## 2-3. The Feature of Product

### 2-3-1. Features (Wind-Free 4Way CST)

#### ■ Wind-Free Cooling with Micro holes

The Wind Free Air conditioner pushes air out through 15,000 micro holes in the panel, producing a dispersed and gentle flow of air actually defined as “still air” and the key here is all of those holes create a still, cooled air flow that infiltrates the room gently and softly.

No Direct Wind & Cold Draft

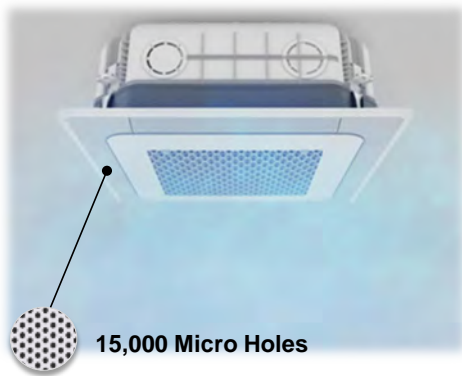

[ Comparison of Room Temp.]

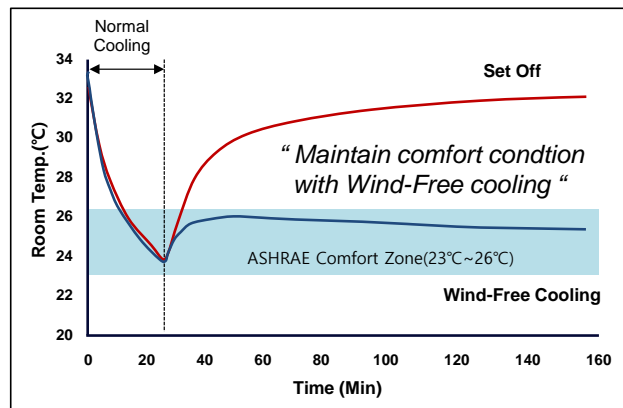

#### ■ Wind-Free Cooling with Micro holes

Quiet Operation

“Extremely quiet with Wind-Free Operation”  
⇒ Suitable for office, school, library.....

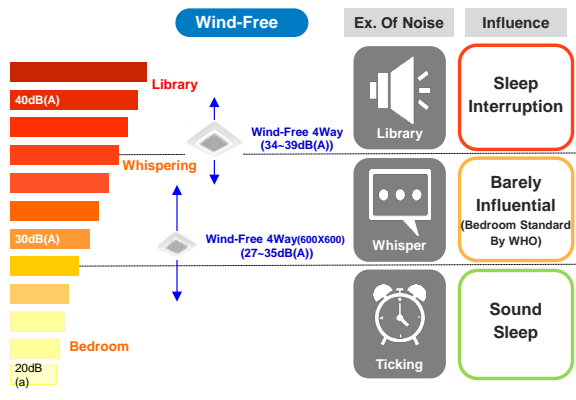

Cost, Energy Saver

“Energy Saving with Wind-Free Operation”

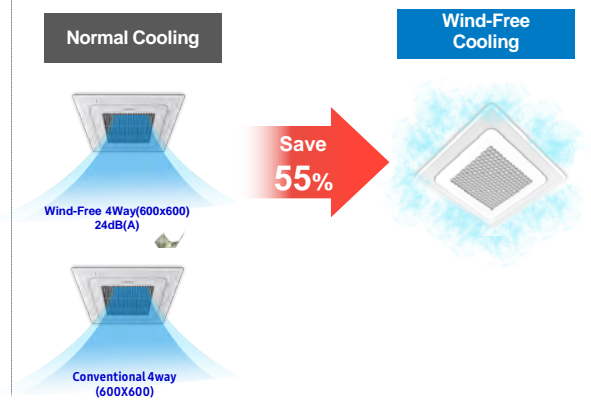



## Features (Wind-Free 4Way CST) (cont.)

- **Big Blade, Long Wind**  
Big and optimized blades enable wider cooling range.

**Wider Cooling Range**

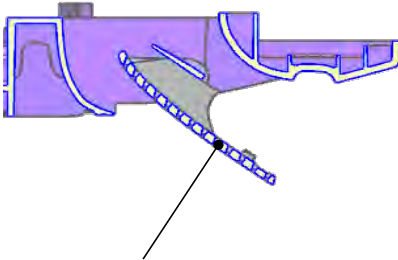

81mm Big Blade (26% ↑)  
Optimized Blade Shape

**Wind-Free 4Way**

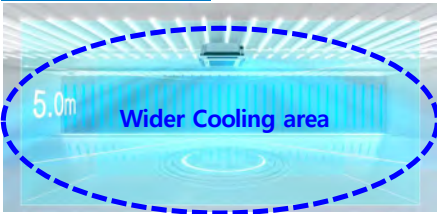

5.0m  
Wider Cooling area

**Conventional 4Way**

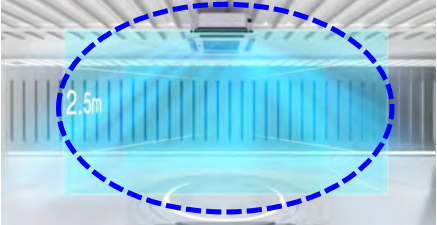

2.5m

- **Smart Comfort Operation**  
Smart comfort operation enable to maintain optimal room condition automatically by detecting not only temperature but also relative humidity.

**Automatic Wind-Free Operation**



If room reaches comfort zone

If room get out of comfort zone

**Normal Cooling**

**Wind-Free Cooling**

**Normal Cooling**

## Features (Wind-Free 4Way CST) (cont.)

### ■ New MDS operation (Option)

New designed Motion Detect enable customized air direction and efficient operation by detecting the location of people.

### Automatic MDS Operation (Option)

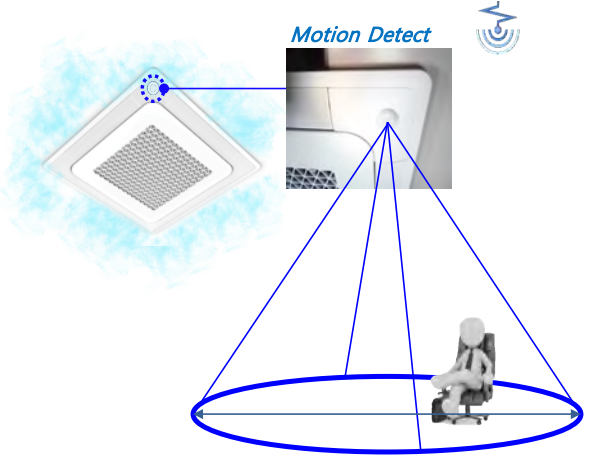

Motion Detect

※ MDS : Motion Detect Sensor

**1. Wind Direction**

"Direct wind or Indirect wind"

Direct wind



Indirect wind



**Choose your comfort**

**2. Energy Saving**

"Wind-Free + OFF\_Control"

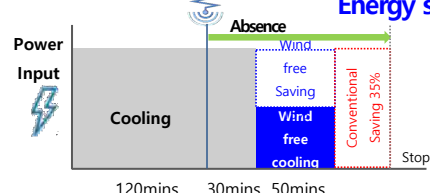

Power Input

120mins 30mins 50mins

35%→50%  
Energy saving

Conventional Saving 35%

### ■ World's Lightest Weight

## Advanced Features

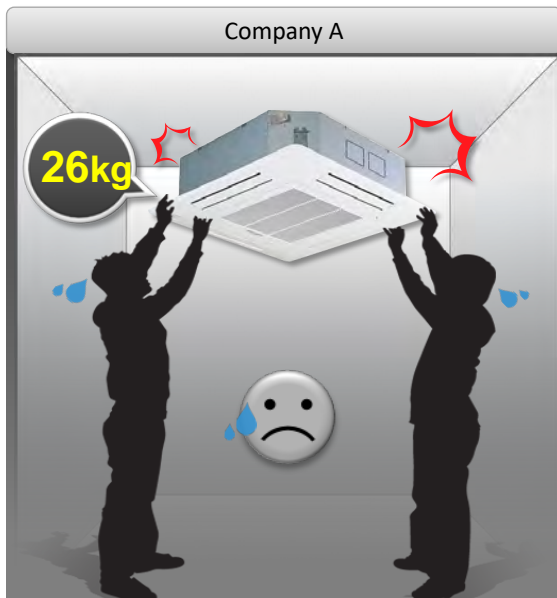

## Features (Wind-Free 4Way CST) (cont.)

### ■ Easy Installation in 4 Different Ways

Freely install anywhere without worrying about direction. (Body and Panel as well)

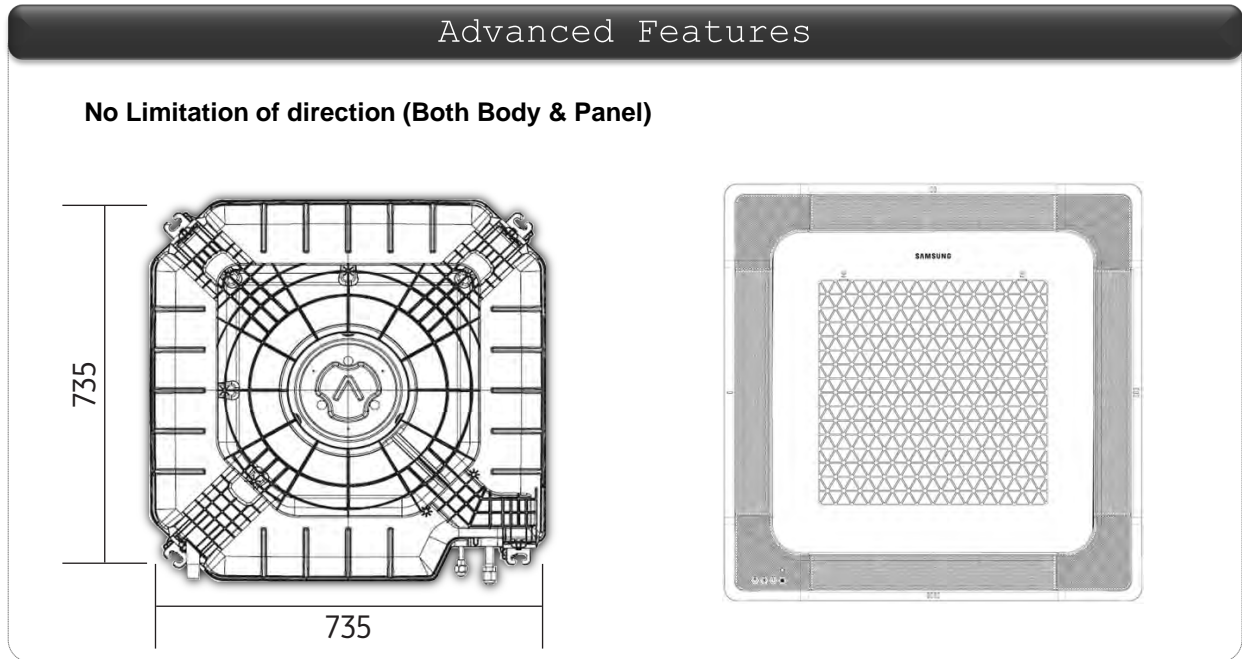

### ■ New Improved Design

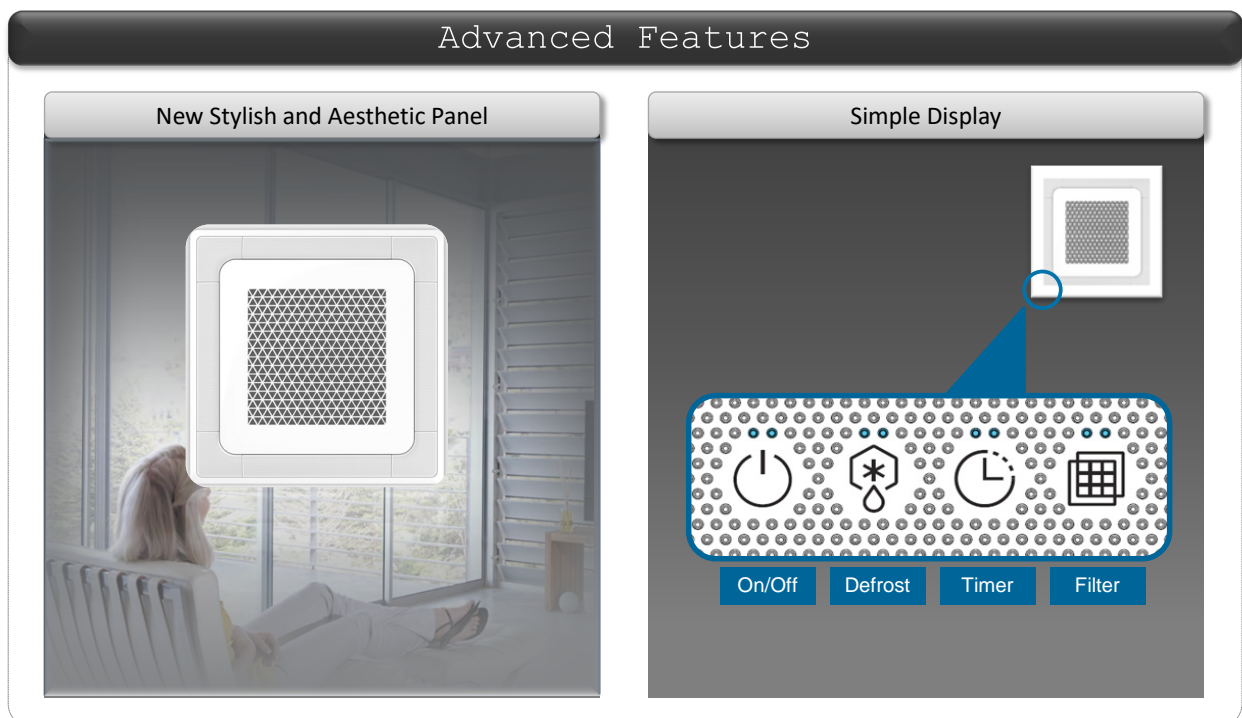

## Features (Wind-Free 4Way CST) (cont.)

### ■ ENo Back Flowing Drain Water

Check Valve on the drain pump prevents drain water from reversing  
→ Minimize water gathering in Drain Board to prevent rusting

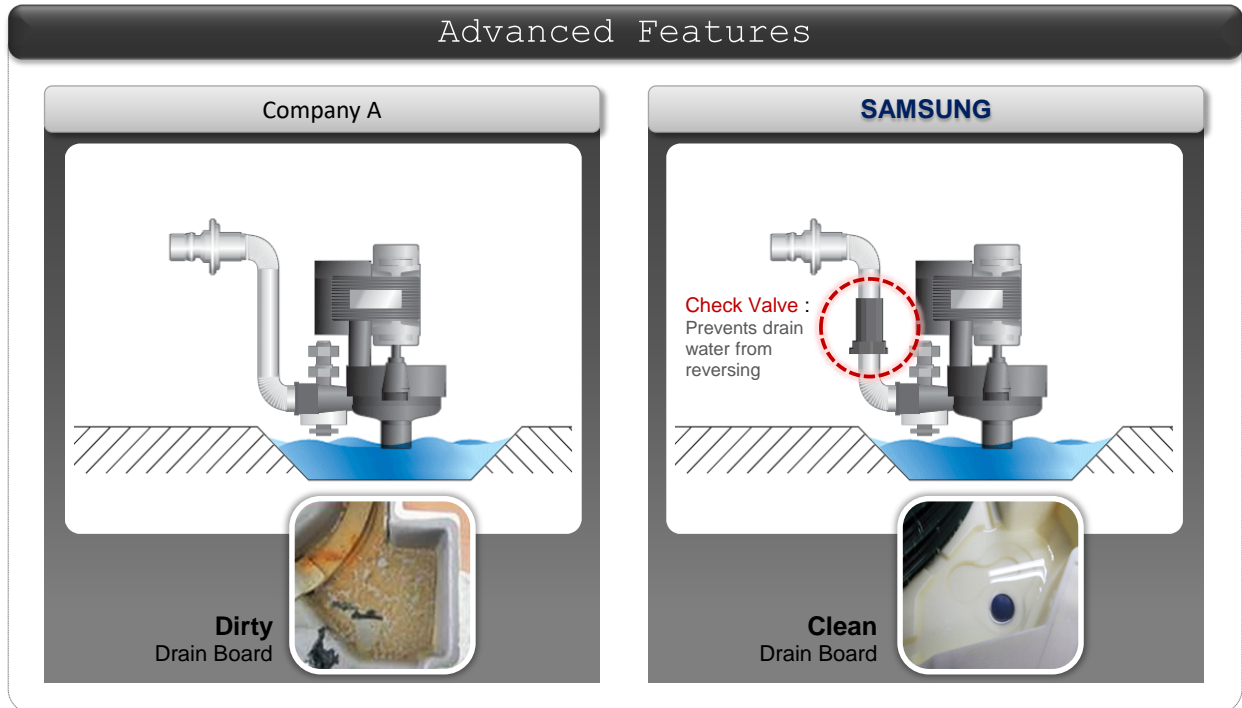

### ■ Easy Maintenance

Easy Air Flow Blade Cleaning

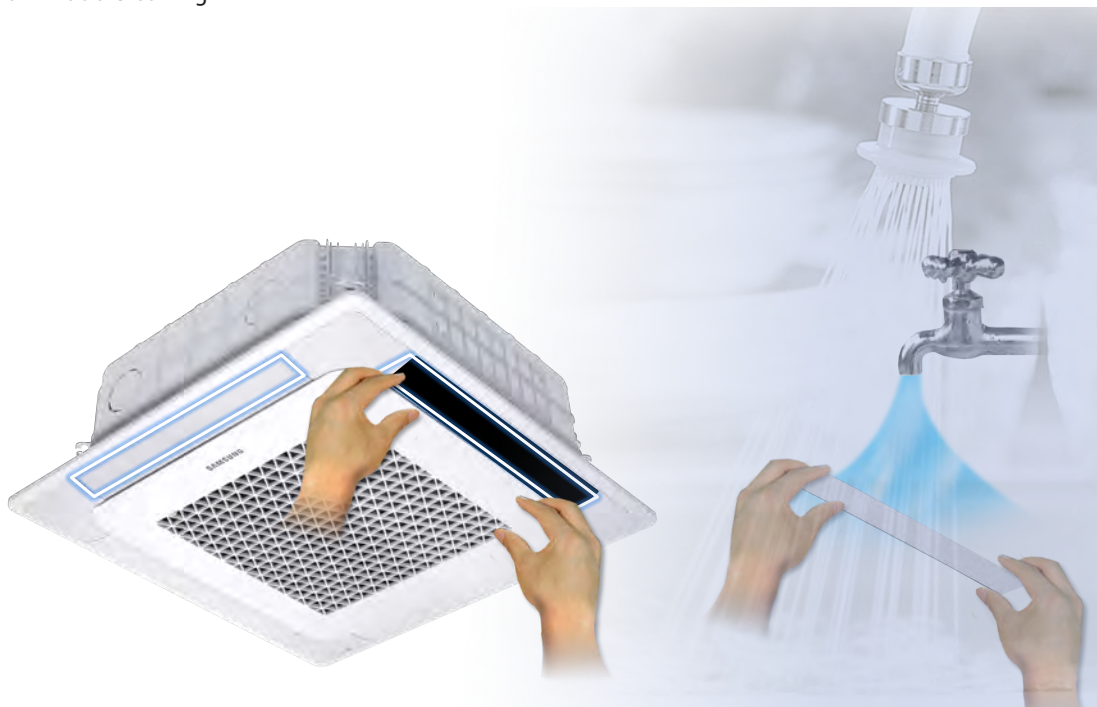

## 2-4. Features & Benefits

---

### 2-4-1. 4Way Cassette (600 x 600)

#### ■ Add chic flair to your interior design with a stylish yet powerful AC system

Samsung's advanced 4Way Cassette (600 x 600) builds on the aesthetic appeal and performance of the standard 4Way Cassette with an enhanced design. The 4Way Cassette (600 x 600) comes in a variety of patterns to complement any interior. The stylish cassette unit visually harmonizes with the indoor space, while efficient cooling and heating performance make it a dependable and practical air conditioning solution. The 4Way Cassette (600 x 600) indoor air conditioning system provides high-performance heating and cooling in an elegant design with features such as:

- **Tasteful design and compact, lightweight build.**  
Create a polished ambiance with a discreetly sized design and a choice of attractive panel patterns.
- **Enhanced comfort control.**  
Optimize comfort and save energy with optional motion detection.
- **Low maintenance and powerful airflow.**  
Ease installation and maintenance and maximize airflow with an efficient design and robust performance.

### 2-4-2. 4Way Cassette (600 x 600) - Tasteful design, Compact, Lightweight build

#### ■ Refine the interior with an elegant, compact design

The enhanced Samsung 4Way Cassette (600 x 600) indoor air conditioner features a selection of simple panel patterns to blend seamlessly into any interior design. Its uniquely lightweight frame blends effortlessly and beautifully into any décor, while clever blade construction keeps the unit clean for a tidy appearance.

#### ■ Attractive panel and display

The 4Way Cassette (600 x 600) features a fashionable panel with a simple, beveled corner design. The rounded panel frame promotes a neat, tidy look for an aesthetic flair that blends perfectly with any ambience.

Waffle Pattern



Classic Pattern



■ **Ultra-compact size**

Samsung's 4Way Cassette (600 x 600) air conditioner can be installed on a single standard ceiling tile (600W x 600D) which helps minimize installation time and effort.

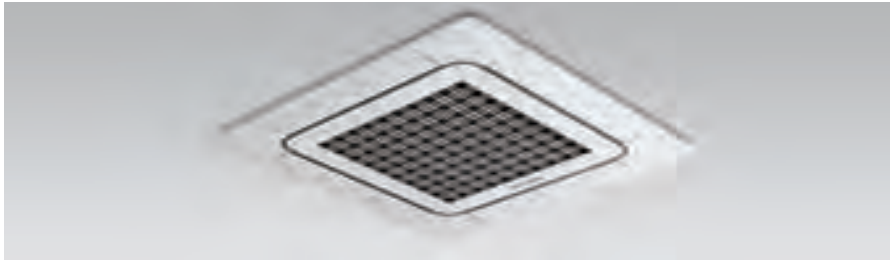

■ **Light, robust design**

The Samsung 4Way Cassette (600 x 600) indoor unit is now lighter in weight at 11kg. It is the lightest indoor unit in the industry, about 35 percent lighter than our conventional products.

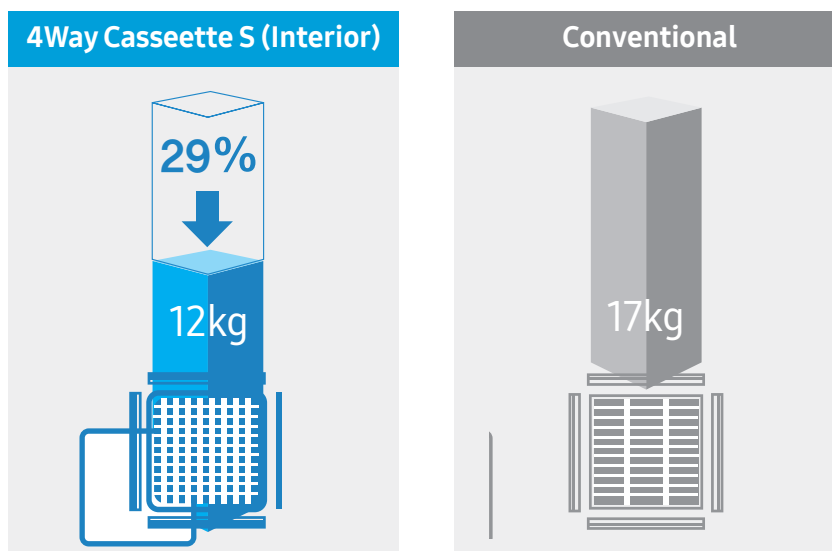

### 2-4-3. 360 Cassette

#### ■ All round cooling and comfort

The Samsung 360 Cassette air conditioner offers a brand new way of staying comfortably cool in every corner of the room. Its innovative circular design not only means it perfectly fits in everywhere, adding a sophisticated look to many different sites, but it also blows cool air in all directions, so that the whole room is the same temperature\*. And its bladeless outlet ensures that cool air is gently dispersed, without creating a cold draft\*\*, and doesn't block the air flow, even at low angles, so it expels 25% more air\* and spreads it farther.

#### ■ EVENLY CIRCULATES & COOLS EVERY CORNER

Unlike 4-way, cassette type air conditioners that create areas of uneven airflow where cool air can't reach\*, a circular outlet blows cool air in all directions, so every corner of a room is the same temperature\*\*.

\* Samsung testing compared to a general 4 way cassette type air conditioner.

\*\* Within an 9.3m radius the temperature difference is less than 0.6°C.



\* Within an 9.3m radius the temperature difference is less than 0.6°C.

#### ■ Comfortably cool, not cold

A bladeless design softly disperses cool air across the room, making you comfortably cool without feeling a cold draft\*\*. With no blades to block the air flow, it also expels 25% more air\* and spreads it farther.



\* Within a 5m radius, no cold draft between 0~1.5m in height (with 14.0kw).

■ **Circular to perfectly fit in everywhere**

Its innovative circular design can match a multitude of interior designs, so it perfectly fits in everywhere. Its minimalist modern styling creates a sophisticated look and its circular shape stands out beautifully.



■ **Spreads more air in more ways**

An innovative Booster Fan enables cool air to be expelled at much lower angles. It creates a low pressure area around the outlet, so that cool air comes out parallel to the ceiling and disperses across a wider area.

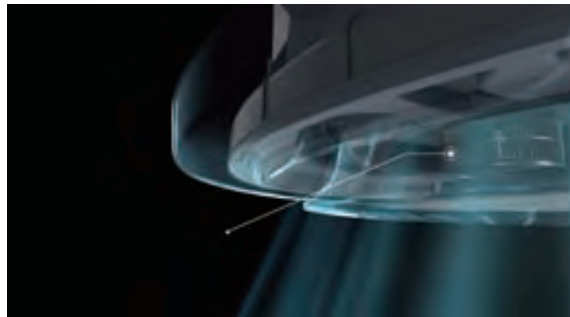

■ **All round simpler & intuitive control**

Intuitively control its performance and see where the air is going. The Wireless Remote Controller's\* Jog shuttle and button offer a fun way to adjust the air flow and a Circular LED Display shows its direction.





## 2-4-4. Duct S

### ■ Overview

Samsung Ducted Type air conditioning units are a smart solution for low-maintenance, consistent cooling and heating performance in any environment. Their compact, slim frame blends seamlessly into ceilings, enhancing the beauty of the interior space and affording users more flexible installation options. Offering a comprehensive lineup, Samsung Ducted Type air conditioning units offer just the right solution for every need—from the office or shop to the restaurant kitchen.

### ■ Experience performance and convenient comfort for any weather condition

Samsung Duct S delivers unparalleled cooling and heating and flexible management with customizable comfort settings in any climate—all year round. Plus, it boasts a slim, compact size and multiple access points for easy setup exactly where needed.



### ■ Smart pressure control

Samsung Ducted Type units feature a smart pressure control system. This system adjusts the fan speed based on the external static pressure (ESP), delivering consistent cooling and heating power, regardless of the surrounding environment.

### ■ Convenient installation

The optional lift-up drain pump lifts condensed water up to 750 mm, compared to a limit of 700 mm on conventional models, for flexible and convenient installation.

The Duct S indoor air conditioning unit delivers smooth, consistent operation and convenience with features such as:

- Efficient operation. Stage the desired atmosphere with energy-efficient performance and customized airflow.
- Smart management. Cool spaces efficiently and manage the air conditioning unit even while away, with features designed for efficiency and control.
- Easy, flexible setup. Install and maintain even multiple units with a compact and easily accessible design.

## 2-4-5. Wall Mount Type

### ■ Breathe easily with wall-mounted systems designed for all-day freshness

Samsung Wall Mount Type air conditioners have been designed from the ground up to be exceptionally efficient. With their stylish, innovative designs, these wall-mounted air conditioners optimize comfort with cool, clean, healthy freshness for everyday living.

### ■ Improved blade operation

Samsung's wide twin blade can open up to 90° for more effective cooling. The longer twin blade ensures that air reaches every corner of the room with greater control.

### ■ Superior dust filtration

A Full High Density (HD) filter creates cleaner air through enhanced filtration, reducing microscopic dust particles by up to 90 percent.

### ■ Cleaner, healthier air

Virus Doctor eliminates the harmful substances and viruses breeding in the atmosphere of living spaces, thus providing the highest level of indoor air quality. This smart solution creates a purified zone, eliminating the hazards of airborne allergens and controlling the active oxygen that contributes to disease, cancer and accelerated aging.

### ■ Good's sleep

Samsung's Wall Mount Type units feature Good's sleep mode for a comfortable bedroom climate perfectly tempered for a restful night. With automatic temperature and moisture adjustment, all three vital stages of sleep are protected from humidity and heat so users wake up fully rested and refreshed.

## 2-4-6. Wall Mounted Wind Free - Wind Free, Auto Clean

### ■ Wind-Free™ Cooling

With Wind-Free™ Cooling mode, cool air is gently dispersed across the room through 23,000 micro air holes. It creates a 'still Air' environment with a very low air speed of just 0.15m/s and no temperature fluctuation – so there are no annoying cold draft and you don't feel too cold, just pleasant comfort.

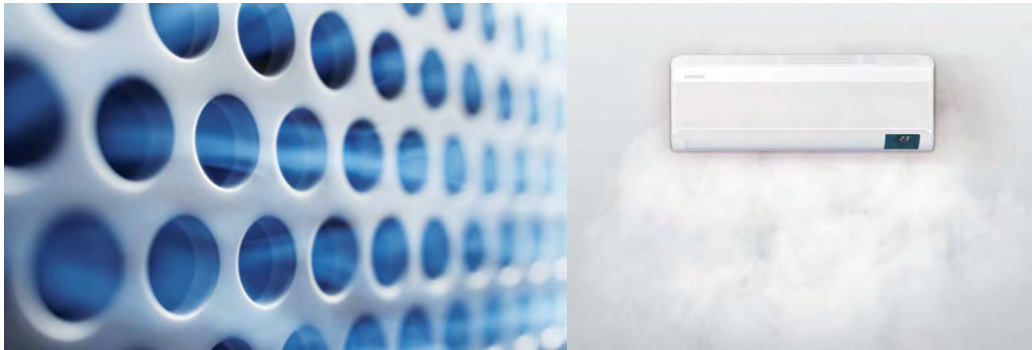



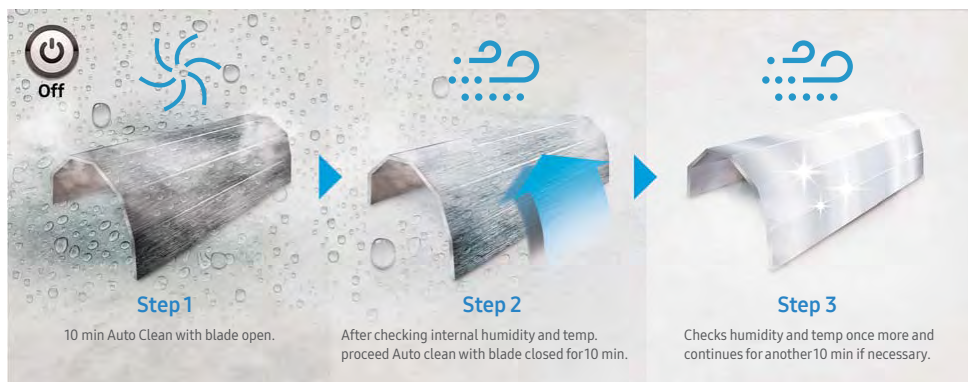

### ■ Auto Clean

Keep the inside of your air conditioner hygienic without much effort at all! After it's been working, the Auto Clean function automatically dries the Heat Exchanger using a 3-step process. It removes moisture by blowing air for between 10 to 30 min. So it prevents the build-up of bacteria and odors.





\*Only available in Wind-Free™ models that have a humidity sensor.





## 2-5. Product Specifications

Item		1way Cassette			
		IN	AC009BN1DCH	AC012BN1DCH	AC018BN1DCH
		OUT	AC009BXADCH	AC012BXADCH	AC018BXADCH
Design	Indoor Unit				
	Outdoor Unit				
	Remote Controller				
Performance	Cooling [Btu/h]		2,700/9,000/12,500	2,900/12,000/12,900	6,800/18,000/19,000
	Heating [Btu/h]		2,400/12,000/18,000	2,900/14,000/20,000	3,600/20,000/28,000
Power Consumption	Cooling [W]		150/670/1,300	160/1,120/1,370	400/1,620/2,540
	Heating [W]		133/1,170/2,150	160/1,410/2,310	330/1,830/4,600
EER/COP	Cooling [Btu/hW]		13.4	10.7	11.1
	Heating [Btu/hW]		3.0	2.9	3.2
Voltage / Frequency			1,2,208-230,60	1,2,208-230,60	1,2,208-230,60
Operating Current	Cooling [A]		1.1/3.3/5.8	1.1/5.1/6.1	2.4/7.3/11.3
	Heating [A]		1.1/5.5/9.5	1.1/6.3/10.0	2.0/8.2/20.0
Sound Pressure	Indoor Unit [dBA] (H/M/L/Silence)		32/29/26/25	35/32/29/28	38/35/33/31
	Outdoor Unit [dBA] (C/H)		46/47	47/48	48/48
Sound Power	Indoor Unit [dBA] (Cooling)		52	55	56
	Outdoor Unit [dBA] (Cooling)		59	61	62
Size	Net Dimension (WxHxD)	Indoor Unit [mm]	970 x 135 x 410	970 x 135 x 410	1,200 x 138 x 450
		Outdoor Unit [mm]	790 x 548 x 285	790 x 548 x 285	880 x 798 x 310
	Shipping Dimension (WxHxD)	Indoor Unit [mm]	1,173 x 231 x 487	1,173 x 231 x 487	1,435 x 224 x 525
		Outdoor Unit [mm]	913 x 622 x 371	913 x 622 x 371	1,023 x 881 x 413
Weight	Net	Indoor Unit [kg]	9.3	9.3	13.4
		Outdoor Unit [kg]	33.3	33.3	53.7
	Gross	Indoor Unit [kg]	12.2	12.2	16.6
		Outdoor Unit [kg]	35.6	35.6	57.7
Harness Specifications	Indoor Fan Motor		DB31-00636G	DB31-00636G	DB31-00332B
	Compressor		DB95-05762A	DB95-05762A	UG8T265FXAEW
	Outdoor Fan Motor		DB31-00642C	DB31-00642C	DB31-00579A
Piping	High Pressure		Φ6.35	Φ6.35	Φ6.35
	Low Pressure		Φ9.52	Φ9.52	Φ12.7
Refrigerant Type			R-410A	R-410A	R-410A
Factory Charging [g]			1,150	1,150	2,000
Additional Refrigerant (Over 5m, for every 5m) [g]			15	15	10
Basic Piping Length [m]			7.5	7.5	7.5
Max. Piping Length [m]			20	20	50
Max. Level Difference [m]			15	15	30
Option Code			0173FC-1930F8-271A23-371120	0173FC-19344D-272328-371120	0183FC-19342C-2A343B-372560
			020010-100031-200000-300000	020010-100051-200000-300000	020010-100051-200000-300000
			030000-100000-200000-300002	030000-100000-200000-300002	030000-100000-200000-300002
			050000-100000-200000-300000	050000-100000-200000-300000	050000-100000-200000-300000





## Product Specifications (cont.)

Item		4way Cassette			
		IN	AC018BN4DCH	AC024BN4DCH	AC030BN4DCH
		OUT	AC018BXADCH	AC024BXADCH	AC030BXADCH
Design	Indoor Unit				
	Outdoor Unit				
	Remote Controller				
Performance	Cooling [Btu/h]		6,000/18,000/26,000	8,000/24,000/32,000	9,000/30,000/35,000
	Heating [Btu/h]		5,500/20,000/31,000	7,000/27,000/40,000	7,500/32,000/43,000
Power Consumption	Cooling [W]		520/1,300/2,420	440/1,900/3,150	610/2,730/4,250
	Heating [W]		300/1,400/4,500	350/2,470/5,330	390/2,760/5,400
EER/COP	Cooling [Btu/hW]		13.8	12.6	11.0
	Heating [Btu/hW]		4.2	3.2	3.4
Voltage / Frequency			1,2,208-230,60	1,2,208-230,60	1,2,208-230,60
Operating Current	Cooling [A]		3.2/5.9/10.8	2.3/8.6/14.0	3.8/12.2/18.9
	Heating [A]		1.9/6.4/20.0	2.2/11.2/23.6	2.4/12.4/24.0
Sound Pressure	Indoor Unit [dBA] (H/M/L)		36/33/30	36/33/30	37/34/30
	Outdoor Unit [dBA] (C/H)		48/48	50/52	50/52
Sound Power	Indoor Unit [dBA] (Cooling)		53	53	53
	Outdoor Unit [dBA] (Cooling)		62	65	67
Size	Net Dimension (WxHxD)	Indoor Unit [mm]	840 x 246 x 840	840 x 246 x 840	840 x 288 x 840
		Outdoor Unit [mm]	880 x 798 x 310	940 x 998 x 330	940 x 998 x 330
	Shipping Dimension (WxHxD)	Indoor Unit [mm]	898 x 316 x 898	898 x 316 x 898	898 x 357 x 898
		Outdoor Unit [mm]	1,023 x 881 x 413	995 x 1,096 x 426	995 x 1,096 x 426
Weight	Net	Indoor Unit [kg]	15.9	16.0	19.0
		Outdoor Unit [kg]	537	72.0	72.0
	Gross	Indoor Unit [kg]	19.4	19.5	22.5
		Outdoor Unit [kg]	57.7	77.0	77.0
Harness Specifications	Indoor Fan Motor		DB31-00578A	DB31-00578A	DB31-00689B
	Compressor		UG8T265FXAEW	UG8T300FUBJUSG	UG8T300FUBJUSG
	Outdoor Fan Motor		DB31-00579A	DB31-00579A	DB31-00579A
Piping	High Pressure		Φ6.35	Φ6.35	Φ9.52
	Low Pressure		Φ12.7	Φ15.88	Φ15.88
Refrigerant Type			R-410A	R-410A	R-410A
Factory Charging [g]			2,000	2,600	2,600
Additional Refrigerant (Over 5m, for every 5m) [g]			10	30	30
Basic Piping Length [m]			7.5	7.5	7.5
Max. Piping Length [m]			50	50	50
Max. Level Difference [m]			30	30	30
Option Code			0143FF-1950C6-2F343B-370020	0143FF-1950C6-27484F-370020	0143FF-195418-275A5E-370040
			020010-100001-200000-300000	020010-100001-200000-300000	020010-100001-200000-300000
			030000-100000-200000-300000	030000-100000-200000-300000	030000-100000-200000-300000
			050000-100000-200000-300000	050000-100000-200000-300000	050000-100000-200000-300000





## Product Specifications (cont.)

Item		4way Cassette			
		IN	AC036BN4DCH	AC042BN4DCH	AC048BN4DCH
		OUT	AC036BXADCH	AC042BXADCH	AC048BXADCH
Design	Indoor Unit				
	Outdoor Unit				
	Remote Controller				
Performance	Cooling [Btu/h]	11,000/36,000/43,000	11,500/42,000/47,000	12,000/48,000/52,000	
	Heating [Btu/h]	12,500/40,000/52,000	12,500/47,000/58,000	13,000/54,000/60,000	
Power Consumption	Cooling [W]	900/3,130/4,300	910/4,200/5,680	950/5,780/6,500	
	Heating [W]	670/3,090/5,400	680/3,830/7,000	700/5,110/7,340	
EER/COP	Cooling [Btu/hW]	11.5	10.0	8.3	
	Heating [Btu/hW]	3.8	3.6	3.1	
Voltage / Frequency		1,2208-230,60	1,2208-230,60	1,2208-230,60	
Operating Current	Cooling [A]	4.7/14.2/19.1	4.8/18.6/25.2	5.0/25.6/28.8	
	Heating [A]	3.5/14.0/24.0	3.6/17.0/31.1	3.7/22.7/32.0	
Sound Pressure	Indoor Unit [dBA] (H/M/L)	43/38/33	44/40/34	45/40/35	
	Outdoor Unit [dBA] (C/H)	52/54	53/55	56/58	
Sound Power	Indoor Unit [dBA] (Cooling)	59	60	61	
	Outdoor Unit [dBA] (Cooling)	69	70	72	
Size	Net Dimension (WxHxD)	Indoor Unit [mm]	840 x 288 x 840	840 x 288 x 840	840 x 288 x 840
		Outdoor Unit [mm]	940 x 1,210 x 330	940 x 1,210 x 330	940 x 1,210 x 330
	Shipping Dimension (WxHxD)	Indoor Unit [mm]	898 x 357 x 898	898 x 357 x 898	898 x 357 x 898
		Outdoor Unit [mm]	995 x 1,388 x 426	995 x 1,388 x 426	995 x 1,388 x 426
Weight	Net	Indoor Unit [kg]	21.2	21.2	21.2
		Outdoor Unit [kg]	86.0	88.5	88.5
	Gross	Indoor Unit [kg]	24.8	24.8	24.8
		Outdoor Unit [kg]	95.5	98.0	98.0
Harness Specifications	Indoor Fan Motor		DB31-00689B	DB31-00689B	DB31-00689B
	Compressor		UG5TK1450FJXSG	UG5TK1450FJXSG	UG5TK1450FJXSG
	Outdoor Fan Motor		DB31-00579A	DB31-00579A	DB31-00579A
Piping	High Pressure		Φ9.52	Φ9.52	Φ9.52
	Low Pressure		Φ15.88	Φ15.88	Φ15.88
Refrigerant Type		R-410A	R-410A	R-410A	
Factory Charging [g]		2,900	3,400	3,400	
Additional Refrigerant (Over 5m, for every 5m) [g]		30	30	30	
Basic Piping Length [m]		7.5	7.5	7.5	
Max. Piping Length [m]		75	75	75	
Max. Level Difference [m]		30	30	30	
Option Code		0143FF-19546A-276975-370040	0143FF-19547B-277D8A-370040	0143FF-19548C-278C9B-370040	
		020010-100001-200000-300000	020010-100001-200000-300000	020010-100001-200000-300000	
		030000-100000-200000-300000	030000-100000-200000-300000	030000-100000-200000-300000	
		050000-100000-200000-300000	050000-100000-200000-300000	050000-100000-200000-300000	

## Product Specifications (cont.)





Item		4way Cassette			
		IN	AC018BN4DCH/AA	AC024BN4DCH/AA	AC030BN4DCH/AA
		OUT	AC018BXSCCC/AA	AC024BXSCCC/AA	AC030BXSCCC/AA
Design	Indoor Unit				
	Outdoor Unit				
	Remote Controller				
Performance	Cooling [Btu/h]		4,000 / 18,000 / 22,000	6,000 / 24,000 / 30,000	9,000 / 30,000 / 36,000
	Heating [Btu/h]		-	-	-
Power Consumption	Cooling [W]		240 / 1,490 / 2,200	300 / 2,140 / 3,690	610 / 2,730 / 4,600
	Heating [W]		-	-	-
EER/COP	Cooling [Btu/hW]		12.1	11.2	11.0
	Heating [W/W]		-	-	-
Voltage / Frequency		1,2,208-230,60		1,2,208-230,60	1,2,208-230,60
Operating Current	Cooling [A]		1.5 / 6.8 / 9.7	1.9 / 9.6 / 16.2	3.1 / 12.1 / 20.2
	Heating [A]		-	-	-
Sound Pressure	Indoor Unit [dBA] (H/M/L)		36/33/29	36/33/30	37/34/30
	Outdoor Unit [dBA] (C/H)		48/-	50/-	52/-
Sound Power	Indoor Unit [dBA] (Cooling)		53	53	53
	Outdoor Unit [dBA] (Cooling)		62	65	67
Size	Net Dimension (WxHxD)	Indoor Unit [mm]	840 x 246 x 840	840 x 246 x 840	840 x 288 x 840
		Outdoor Unit [mm]	880 x 638 x 310	880 x 798 x 310	940 x 998 x 330
	Shipping Dimension (WxHxD)	Indoor Unit [mm]	898 x 316 x 898	898 x 316 x 898	898 x 357 x 898
		Outdoor Unit [mm]	1,023 x 881 x 413	1,023 x 881 x 413	995 x 1,096 x 426
Weight	Net	Indoor Unit [kg]	15.9	16.0	19.0
		Outdoor Unit [kg]	40.5	52.5	71.0
	Gross	Indoor Unit [kg]	19.4	19.5	22.5
		Outdoor Unit [kg]	43.5	56.5	76.0
Harness Specifications	Indoor Fan Motor		DB31-00578A	DB31-00578A	DB31-00689B
	Compressor		UG9TK3150FE4SG	UG4T200FUA4E4SG	UG8T300FUBJUSG
	Outdoor Fan Motor		DB31-00683A	DB31-00683A	DB31-00683A
Piping	High Pressure		Φ6.35	Φ6.35	Φ9.52
	Low Pressure		Φ12.7	Φ15.88	Φ15.88
Refrigerant Type		R-410A		R-410A	R-410A
Factory Charging [g]		1,300		2,000	2,400
Additional Refrigerant (over 7.5m) [g]		15		10	30
Basic Piping Length [m]		7.5		7.5	7.5
Max. Piping Length [m]		30		50	50
Max. Level Difference [m]		20		30	30
Option Code		0143FF-1950C6-2F343B-370020		0143FF-1950C6-27484F-370020	0143FF-195418-275A5E-370040
		020010-100001-200000-300000		020010-100001-200000-300000	020010-100001-200000-300000
		030000-100000-200000-300000		030000-100000-200000-300000	030000-100000-200000-300000
		050000-100000-200000-300000		050000-100000-200000-300000	050000-100000-200000-300000

## Product Specifications (cont.)





Item		4way Cassette			
		IN	AC036BN4DCH/AA	AC030BN4DCH/AA	AC036BN4DCH/AA
		OUT	AC036BXSCC/AA	AC030BXSCC/AA	AC036BXSCC/AA
Design	Indoor Unit				
	Outdoor Unit				
	Remote Controller				
Performance	Cooling [Btu/h]	10,000 / 36,000 / 40,000	13,000 / 30,000 / 36,000	14,000 / 36,000 / 42,000	
	Heating [Btu/h]	-	10,000 / 34,000 / 40,000	10,500 / 40,000 / 45,000	
Power Consumption	Cooling [W]	700 / 3,600 / 4,800	800 / 2,270 / 3,200	850 / 2,770 / 3,900	
	Heating [W]	-	530 / 2,590 / 4,500	550 / 3,050 / 4,800	
EER/COP	Cooling [Btu/hW]	10.0	13.2	13.0	
	Heating [W/W]		3.85	3.85	
Voltage / Frequency		1,2,208-230,60	1,2,208-230,60	1,2,208-230,60	
Operating Current	Cooling [A]	3.6 / 15.8 / 21.1	4.2 / 10.3 / 14.3	4.5 / 12.5 / 17.1	
	Heating [A]	-	2.8 / 11.9 / 19.8	2.9 / 13.8 / 21.1	
Sound Pressure	Indoor Unit [dBA] (H/M/L)	43/38/33	37/34/30	43/38/33	
	Outdoor Unit [dBA] (C/H)	54/-	49/50	49/51	
Sound Power	Indoor Unit [dBA] (Cooling)	59	53	59	
	Outdoor Unit [dBA] (Cooling)	69	67	69	
Size	Net Dimension (WxHxD)	Indoor Unit [mm]	840 x 288 x 840	840 x 288 x 840	840 x 288 x 840
		Outdoor Unit [mm]	940 x 998 x 330	940 x 1,420 x 330	940 x 1,420 x 330
	Shipping Dimension (WxHxD)	Indoor Unit [mm]	898 x 357 x 898	898 x 357 x 898	898 x 357 x 898
		Outdoor Unit [mm]	995 x 1,096 x 426	995 x 1,598 x 426	995 x 1,598 x 426
Weight	Net	Indoor Unit [kg]	21.2	19.0	21.2
		Outdoor Unit [kg]	71.0	100.0	100.0
	Gross	Indoor Unit [kg]	24.8	22.5	24.8
		Outdoor Unit [kg]	76.0	110.0	110.0
Harness Specifications	Indoor Fan Motor		DB31-00689B	DB31-00689B	DB31-00689B
	Compressor		UG8T300FUBJUSG	ATQ420D1UNT1	ATQ420D1UNT1
	Outdoor Fan Motor		DB31-00683A	DB31-00579A	DB31-00579A
Piping	High Pressure		Φ9.52	Φ9.52	Φ9.52
	Low Pressure		Φ15.88	Φ15.88	Φ15.88
Refrigerant Type		R-410A	R-410A	R-410A	
Factory Charging [g]		2,400	4,000	4,000	
Additional Refrigerant (over 7.5m) [g]		30	30	30	
Basic Piping Length [m]		7.5	7.5	7.5	
Max. Piping Length [m]		50	75	75	
Max. Level Difference [m]		30	30	30	
Option Code		0143FF-19546A-276975-370040	0143FF-195418-275A5E-370040	0143FF-19546A-276975-370040	
		020010-100001-200000-300000	020010-100001-200000-300000	020010-100001-200000-300000	
		030000-100000-200000-300000	030000-100000-200000-300000	030000-100000-200000-300000	
		050000-100000-200000-300000	050000-100000-200000-300000	050000-100000-200000-300000	





## Product Specifications (cont.)

Item		4way Cassette(600x600)			
		IN	AC009BNNDCH	AC012BNNDCH	AC018BNNDCH
		OUT	AC009BXADCH	AC012BXADCH	AC018BXADCH
Design	Indoor Unit				
	Outdoor Unit				
	Remote Controller				
Performance	Cooling [Btu/h]	3,400/9,100/14,000	3,500/10,800/14,500	5,500/17,400/21,000	
	Heating [Btu/h]	2,900/10,000/15,000	3,000/13,500/15,500	3,300/20,000/23,500	
Power Consumption	Cooling [W]	190/700/1,460	190/860/1,480	370/1,580/2,350	
	Heating [W]	150/680/1,750	150/1,070/1,800	290/2,020/3,600	
EER/COP	Cooling [Btu/hW]	13.0	12.5	11.0	
	Heating [Btu/hW]	4.3	3.7	2.9	
Voltage / Frequency		1,2,208-230,60	1,2,208-230,60	1,2,208-230,60	
Operating Current	Cooling [A]	1.3/3.3/6.5	1.3/4.1/6.6	2.3/7.2/10.4	
	Heating [A]	1.1/3.2/7.9	1.1/4.8/8.0	1.8/9.1/16.0	
Sound Pressure	Indoor Unit [dBA] (H/M/L)	31/28/25	34/30/25	39/34/29	
	Outdoor Unit [dBA] (C/H)	46/47	47/48	48/48	
Sound Power	Indoor Unit [dBA] (Cooling)	48	51	56	
	Outdoor Unit [dBA] (Cooling)	59	61	62	
Size	Net Dimension (WxHxD)	Indoor Unit [mm]	575 x 250 x 575	575 x 250 x 575	575 x 250 x 575
		Outdoor Unit [mm]	790 x 548 x 285	790 x 548 x 285	880 x 798 x 310
	Shipping Dimension (WxHxD)	Indoor Unit [mm]	623 x 298 x 653	623 x 298 x 653	623 x 298 x 653
		Outdoor Unit [mm]	913 x 622 x 371	913 x 622 x 371	1,023 x 881 x 413
Weight	Net	Indoor Unit [kg]	11.6	11.6	11.6
		Outdoor Unit [kg]	33.3	33.3	53.7
	Gross	Indoor Unit [kg]	13.8	13.8	13.8
		Outdoor Unit [kg]	35.6	35.6	57.7
Harness Specifications	Indoor Fan Motor		DB31-00578C	DB31-00578C	DB31-00578C
	Compressor		DB95-05762A	DB95-05762A	UG8T265FXAEW
	Outdoor Fan Motor		DB31-00642C	DB31-00642C	DB31-00579A
Piping	High Pressure		Φ6.35	Φ6.35	Φ6.35
	Low Pressure		Φ9.52	Φ9.52	Φ12.7
Refrigerant Type		R-410A	R-410A	R-410A	
Factory Charging [g]		1,150	1,150	2,000	
Additional Refrigerant (Over 5m, for every 5m) [g]		15	15	10	
Basic Piping Length [m]		7.5	7.5	7.5	
Max. Piping Length [m]		20	20	50	
Max. Level Difference [m]		15	15	30	
Option Code		0153FF-1910C8-271A23-370040	0153FF-1930F9-272328-370000	0153FF-19345D-25343B-370000	
		020010-100001-200000-300000	020010-100001-200000-300000	020010-100001-200000-300000	
		030000-100000-200000-300002	030000-100000-200000-300002	030000-100000-200000-300002	
		050000-100000-200000-300000	050000-100000-200000-300000	050000-100000-200000-300000	





## Product Specifications (cont.)

Item		360 Cassette			
		IN	AC018BN6DCH	AC024BN6DCH	AC030BN6DCH
		OUT	AC018BXADCH	AC024BXADCH	AC030BXADCH
Design	Indoor Unit				
	Outdoor Unit				
	Remote Controller				
Performance	Cooling [Btu/h]	6,000/18,000/25,000	8,000/24,000/32,000	9,000/30,000/35,000	
	Heating [Btu/h]	4,900/20,000/28,000	7,000/27,000/40,000	7,500/32,000/43,000	
Power Consumption	Cooling [W]	450/1,460/2,420	440/1,890/3,150	610/2,730/4,250	
	Heating [W]	340/1,720/4,240	350/2,470/5,330	390/2,760/5,400	
EER/COP	Cooling [Btu/hW]	12.3	12.7	11.0	
	Heating [Btu/hW]	3.4	3.2	3.4	
Voltage / Frequency		1,2,208-230,60	1,2,208-230,60	1,2,208-230,60	
Operating Current	Cooling [A]	2.3/6.7/10.7	2.3/8.6/14	3.8/12.4/18.9	
	Heating [A]	1.9/7.9/18.8	2.4/11.1/23.6	2.4/12.4/24.0	
Sound Pressure	Indoor Unit [dBA] (H/M/L)	35/32/29	36/33/29	38/35/31	
	Outdoor Unit [dBA] (C/H)	48/48	50/52	50/52	
Sound Power	Indoor Unit [dBA] (Cooling)	52	52	55	
	Outdoor Unit [dBA] (Cooling)	62	65	67	
Size	Net Dimension (WxHxD)	Indoor Unit [mm]	947 x 281 x 947	947 x 365 x 947	947 x 365 x 947
		Outdoor Unit [mm]	880 x 798 x 310	940 x 998 x 330	940 x 998 x 330
	Shipping Dimension (WxHxD)	Indoor Unit [mm]	990 x 330 x 990	990 x 414 x 990	990 x 414 x 990
		Outdoor Unit [mm]	1,023 x 881 x 413	995 x 1,096 x 426	995 x 1,096 x 426
Weight	Net	Indoor Unit [kg]	20.0	23.3	23.3
		Outdoor Unit [kg]	53.7	72.0	72.0
	Gross	24.9	28.0	28.0	28.0
		Outdoor Unit [kg]	57.7	77.0	77.0
Harness Specifications	Indoor Fan Motor		DB31-00578E	DB31-00577D	DB31-00577D
	Compressor		UG8T265FXAEW	UG8T300FUBJUSG	UG8T300FUBJUSG
	Outdoor Fan Motor		DB31-00579A	DB31-00579A	DB31-00579A
Piping	High Pressure		Φ6.35	Φ6.35	Φ9.52
	Low Pressure		Φ12.7	Φ15.88	Φ15.88
Refrigerant Type		R-410A			
Factory Charging [g]		2,000			
Additional Refrigerant (Over 5m, for every 5m) [g]		10			
Basic Piping Length [m]		7.5			
Max. Piping Length [m]		50			
Max. Level Difference [m]		30			
Option Code		0103FF-1950D8-2A343B-370000	0103FF-1950D8-27484F-370040	0103FF-19541A-275A5E-370040	
		020010-100000-200000-300000	020010-100000-200000-300000	020010-100000-200000-300000	
		030000-100000-200000-300000	030000-100000-200000-300000	030000-100000-200000-300000	
		050000-100000-200000-300000	050000-100000-200000-300000	050000-100000-200000-300000	





## Product Specifications (cont.)

Item		360 Cassette			
		IN	AC036BN6DCH	AC042BN6DCH	AC048BN6DCH
		OUT	AC036BXADCH	AC042BXADCH	AC048BXADCH
Design	Indoor Unit				
	Outdoor Unit				
	Remote Controller				
Performance	Cooling [Btu/h]		11,000/36,000/43,000	11,500/42,000/47,000	12,000/48,000/52,000
	Heating [Btu/h]		12,500/40,000/52,000	12,500/47,000/58,000	13,000/54,000/60,000
Power Consumption	Cooling [W]		900/3,130/4,310	910/4,200/5,680	950/5,780/6,500
	Heating [W]		670/3,260/5,500	680/4,170/7,390	700/5,460/7,390
EER/COP	Cooling [Btu/hW]		11.5	10.0	8.3
	Heating [Btu/hW]		3.6	3.3	2.9
Voltage / Frequency		1,2,208-230,60		1,2,208-230,60	1,2,208-230,60
Operating Current	Cooling [A]		4.6/13.9/19.1	4.7/18.6/25.2	4.9/25.6/28.8
	Heating [A]		3.6/14.5/24.0	3.5/18.5/32.0	3.6/24.7/32.0
Sound Pressure	Indoor Unit [dBA]		43/38/32	44/40/34	45/40/35
	Outdoor Unit [dBA]		52/54	53/55	56/58
Sound Power	Indoor Unit [dBA] (Cooling) (H/M/L)		59	60	61
	Outdoor Unit [dBA] (Cooling) (C/H)		69	70	72
Size	Net Dimension (WxHxD)	Indoor Unit [mm]	947 x 365 x 947	947 x 365 x 947	947 x 365 x 947
		Outdoor Unit [mm]	940 x 1,210 x 330	940 x 1,210 x 330	940 x 1,210 x 330
	Shipping Dimension (WxHxD)	Indoor Unit [mm]	990 x 414 x 990	990 x 414 x 990	990 x 414 x 990
		Outdoor Unit [mm]	995 x 1,388 x 426	995 x 1,388 x 426	995 x 1,388 x 426
Weight	Net	Indoor Unit [kg]	25.2	25.2	25.2
		Outdoor Unit [kg]	86.0	88.5	88.5
	Gross	Indoor Unit [kg]	30.2	30.2	30.2
		Outdoor Unit [kg]	95.5	98.0	98.0
Harness Specifications	Indoor Fan Motor		DB31-00577D	DB31-00577D	DB31-00577D
	Compressor		UG5TK1450FJXSG	UG5TK1450FJXSG	UG5TK1450FJXSG
	Outdoor Fan Motor		DB31-00579A	DB31-00579A	DB31-00579A
Piping	High Pressure		Φ9.52	Φ9.52	Φ9.52
	Low Pressure		Φ15.88	Φ15.88	Φ15.88
Refrigerant Type		R-410A		R-410A	R-410A
Factory Charging [g]		2,900		3,400	3,400
Additional Refrigerant (Over 5m, for every 5m) [g]		30		30	30
Basic Piping Length [m]		7.5		7.5	7.5
Max. Piping Length [m]		75		75	75
Max. Level Difference [m]		30		30	30
Option Code		0113FF-19548C-276975-370040		0113FF-19549D-277D8A-370040	0113FF-1954AF-278C9B-370040
		020010-100000-200000-300000		020010-100000-200000-300000	020010-100000-200000-300000
		030000-100000-200000-300000		030000-100000-200000-300000	030000-100000-200000-300000
		050000-100000-200000-300000		050000-100000-200000-300000	050000-100000-200000-300000





## Product Specifications (cont.)

Item		Home Duct			
		IN	AC009BNLDCH	AC012BNLDCH	AC018BNLDCH
		OUT	AC009BXADCH	AC012BXADCH	AC018BXADCH
Design	Indoor Unit				
	Outdoor Unit				
	Remote Controller				
Performance	Cooling [Btu/h]	3,000/9,000/13,000	3,200/12,000/14,000	5,500/18,000/22,000	
	Heating [Btu/h]	2,900/12,000/16,000	3,000/14,000/17,000	3,000/20,000/25,000	
Power Consumption	Cooling [W]	180/640/1,320	190/1,000/1,340	400/1,490/2,440	
	Heating [W]	160/1,000/2,020	170/1,140/2,100	300/1,830/3,610	
EER/COP	Cooling [Btu/hW]	14.0	12.0	12.1	
	Heating [Btu/hW]	3.5	3.6	3.2	
Voltage / Frequency		1,2,208-230,60	1,2,208-230,60	1,2,208-230,60	
Operating Current	Cooling [A]	1.2/3.3/5.9	1.3/4.7/5.9	2.4/6.7/10.8	
	Heating [A]	1.1/4.7/9.0	1.1/5.1/9.3	1.8/8.2/16.0	
Sound Pressure	Indoor Unit [dBA] (H/M/L)	33/30/26	34/31/27	35/32/28	
	Outdoor Unit [dBA] (C/H)	46/47	47/48	48/48	
Sound Power	Indoor Unit [dBA] (Cooling)	50	51	52	
	Outdoor Unit [dBA] (Cooling)	59	61	62	
Size	Net Dimension (WxHxD)	Indoor Unit [mm]	900 x 199 x 440	900 x 199 x 440	1,100 x 199 x 440
		Outdoor Unit [mm]	790 x 548 x 285	790 x 548 x 285	880 x 798 x 310
	Shipping Dimension (WxHxD)	Indoor Unit [mm]	1,151 x 280 x 544	1,151 x 280 x 544	1,351 x 280 x 544
		Outdoor Unit [mm]	913 x 622 x 371	913 x 622 x 371	1,023 x 881 x 413
Weight	Net	Indoor Unit [kg]	18.9	18.9	22.4
		Outdoor Unit [kg]	33.3	33.3	53.7
	Gross	Indoor Unit [kg]	22.0	22.0	25.9
		Outdoor Unit [kg]	35.6	35.6	57.7
Harness Specifications	Indoor Fan Motor		DB31-00671A	DB31-00671A	DB31-00671B
	Compressor		DB95-05762A	DB95-05762A	UG8T265FXAEW
	Outdoor Fan Motor		DB31-00642C	DB31-00642C	DB31-00579A
Piping	High Pressure		Φ6.35	Φ6.35	Φ6.35
	Low Pressure		Φ9.52	Φ9.52	Φ12.7
Refrigerant Type		R-410A	R-410A	R-410A	
Factory Charging [g]		1,150	1,150	2,000	
Additional Refrigerant (Over 5m, for every 5m) [g]		15	15	10	
Basic Piping Length [m]		7.5	7.5	7.5	
Max. Piping Length [m]		20	20	50	
Max. Level Difference [m]		15	15	30	
Option Code		01C3FC-1C546B-271A23-370000	01C3FC-1C55F0-272328-370000	01C3FC-1C583D-23343C-370000	
		020010-120000-200000-300000	020010-120000-200000-300000	020010-120000-200000-300000	
		030000-100000-200000-300002	030000-100000-200000-300002	030000-100000-200000-300002	
		050000-100000-200000-300000	050000-100000-200000-300000	050000-100000-200000-300000	



## Product Specifications (cont.)

Item		Duct S			
		IN	AC009BNHDCH	AC012BNHDCH	AC018BNHDCH
		OUT	AC009BXADCH	AC012BXADCH	AC018BXADCH
Design	Indoor Unit				
	Outdoor Unit				
	Remote Controller				
Performance	Cooling [Btu/h]	3,300/9,000/14,000	3,500/12,000/15,000	6,000/18,000/24,000	
	Heating [Btu/h]	2,800/12,000/15,000	3,000/14,000/18,000	5,000/20,000/30,000	
Power Consumption	Cooling [W]	210/690/1,440	210/960/1,480	420/1,440/2,480	
	Heating [W]	160/930/2,000	170/1,050/2,200	350/1,540/4,300	
EER/COP	Cooling [Btu/hW]	13.1	12.5	12.5	
	Heating [Btu/hW]	3.8	3.9	3.8	
Voltage / Frequency		1,2208-230,60	1,2208-230,60	1,2208-230,60	
Operating Current	Cooling [A]	1.4/3.3/6.4	1.4/4.5/6.6	2.5/6.6/11	
	Heating [A]	1.1/4.4/8.9	1.1/4.8/9.8	2/7.0/19.0	
Sound Pressure	Indoor Unit [dBA] (H/M/L)	30/27/23	31/28/25	34/30/26	
	Outdoor Unit [dBA] (C/H)	46/47	47/48	48/48	
Sound Power	Indoor Unit [dBA] (Cooling)	49	50	56	
	Outdoor Unit [dBA] (Cooling)	59	61	62	
Size	Net Dimension (WxHxD)	Indoor Unit [mm]	850 x 250 x 700	850 x 250 x 700	1,200 x 250 x 700
		Outdoor Unit [mm]	790 x 548 x 285	790 x 548 x 285	880 x 798 x 310
	Shipping Dimension (WxHxD)	Indoor Unit [mm]	1,064 x 320 x 784	1,064 x 320 x 784	1,429 x 320 x 779
		Outdoor Unit [mm]	913 x 622 x 371	913 x 622 x 371	1,023 x 881 x 413
Weight	Net	Indoor Unit [kg]	26.7	26.7	34.9
		Outdoor Unit [kg]	33.3	33.3	53.7
	Gross	Indoor Unit [kg]	30.7	30.7	39.4
		Outdoor Unit [kg]	35.6	35.6	57.7
Harness Specifications	Indoor Fan Motor		DB31-00639B	DB31-00639B	DB31-00639B
	Compressor		DB95-05762A	DB95-05762A	UG8T265FXAEW
	Outdoor Fan Motor		DB31-00642C	DB31-00642C	DB31-00579A
Piping	High Pressure		Φ6.35	Φ6.35	Φ6.35
	Low Pressure		Φ9.52	Φ9.52	Φ12.7
Refrigerant Type		R-410A	R-410A	R-410A	
Factory Charging [g]		1,150	1,150	2,000	
Additional Refrigerant (Over 5m, for every 5m) [g]		15	15	10	
Basic Piping Length [m]		7.5	7.5	7.5	
Max. Piping Length [m]		20	20	50	
Max. Level Difference [m]		15	15	30	
Option Code		01B3FC-1C50D3-271A23-370000	01B3FC-1C5404-272328-370000	01B3FC-1C5416-2F343C-370020	
		020010-120000-200000-300000	020010-120000-200000-300000	020010-120000-200000-300000	
		030000-100000-200000-300000	030000-100000-200000-300000	030000-100000-200000-300000	
		050000-100000-200000-300000	050000-100000-200000-300000	050000-100000-200000-300000	





## Product Specifications (cont.)

Item		Duct S			
		IN	AC024BNHDCH	AC030BNHDCH	AC036BNHDCH
		OUT	AC024BXADCH	AC030BXADCH	AC036BXADCH
Design	Indoor Unit				
	Outdoor Unit				
	Remote Controller				
Performance	Cooling [Btu/h]		8,400/24,000/32,000	8,600/30,000/34,000	11,500/36,000/44,000
	Heating [Btu/h]		7,000/27,000/39,000	7,900/32,000/41,000	10,500/40,000/56,000
Power Consumption	Cooling [W]		460/1,900/3,130	650/2,910/3,830	880/3,360/4,350
	Heating [W]		360/2,400/5,300	510/2,840/5,400	650/3,450/5,790
EER/COP	Cooling [Btu/hW]		12.6	10.3	10.7
	Heating [Btu/hW]		3.3	3.3	3.4
Voltage / Frequency		1,2208-230,60		1,2208-230,60	1,2208-230,60
Operating Current	Cooling [A]		2.4/8.8/14.2	3.5/13.3/17.2	4.8/15.4/19.3
	Heating [A]		2.3/11.0/23.5	3.1/13.0/24.0	3.5/15.6/24.0
Sound Pressure	Indoor Unit [dBA] (H/M/L)		36/32/28	41/37/33	43/39/35
	Outdoor Unit [dBA] (C/H)		50/52	50/52	52/54
Sound Power	Indoor Unit [dBA] (Cooling)		58	63	65
	Outdoor Unit [dBA] (Cooling)		65	67	69
Size	Net Dimension (WxHxD)	Indoor Unit [mm]	1,200 x 250 x 700	1,200 x 250 x 700	1,300 x 300 x 700
		Outdoor Unit [mm]	940 x 998 x 330	940 x 998 x 330	940 x 1,210 x 330
	Shipping Dimension (WxHxD)	Indoor Unit [mm]	1,429 x 320 x 779	1,429 x 320 x 779	1,529 x 370 x 779
		Outdoor Unit [mm]	995 x 1,096 x 426	995 x 1,096 x 426	995 x 1,388 x 426
Weight	Net	Indoor Unit [kg]	35.0	35.0	44.0
		Outdoor Unit [kg]	72.0	72.0	86.0
	Gross	Indoor Unit [kg]	39.5	39.5	50.0
		Outdoor Unit [kg]	77.0	77.0	95.5
Harness Specifications	Indoor Fan Motor		DB31-00639B	DB31-00639B	DB31-00641B
	Compressor		UG8T300FUBJUSG	UG8T300FUBJUSG	UG5TK1450FJXSG
	Outdoor Fan Motor		DB31-00579A	DB31-00579A	DB31-00579A
Piping	High Pressure		Φ6.35	Φ9.52	Φ9.52
	Low Pressure		Φ15.88	Φ15.88	Φ15.88
Refrigerant Type		R-410A		R-410A	R-410A
Factory Charging [g]		2,600		2,600	2,900
Additional Refrigerant (Over 5m, for every 5m) [g]		30		30	30
Basic Piping Length [m]		7.5		7.5	7.5
Max. Piping Length [m]		50		50	75
Max. Level Difference [m]		30		30	30
Option Code		01B3FC-1C542A-27484F-370020		01B3FC-1C59B9-275A5E-370020	01B3FC-1C5933-276975-370045
		020010-120000-200000-300000		020010-120000-200000-300000	020010-120000-200000-300000
		030000-100000-200000-300000		030000-100000-200000-300000	030000-100000-200000-300000
		050000-100000-200000-300000		050000-100000-200000-300000	050000-100000-200000-300000

## Product Specifications (cont.)





Item		Duct S		
		IN	AC042BNHDCH	AC048BNHDCH
			OUT	AC042BXADCH
Design	Indoor Unit			
	Outdoor Unit			
	Remote Controller			
Performance	Cooling [Btu/h]	12,000/42,000/46,000		12,500/48,000/51,000
	Heating [Btu/h]	11,000/47,000/63,000		11,500/54,000/65,000
Power Consumption	Cooling [W]	920/4,570/5,490		960/6,000/6,500
	Heating [W]	720/4,300/7,530		750/5,650/7,670
EER/COP	Cooling [Btu/hW]	9.2		8.0
	Heating [Btu/hW]	3.2		2.8
Voltage / Frequency		1,2,208-230,60		1,2,208-230,60
Operating Current	Cooling [A]	5.0/20.3/24.4		5.2/26.6/28.8
	Heating [A]	3.9/19.1/32.0		4.1/25.1/32.0
Sound Pressure	Indoor Unit [dBA] (H/M/L)	44/41/38		45/43/41
	Outdoor Unit [dBA] (C/H)	53/55		56/58
Sound Power	Indoor Unit [dBA] (Cooling)	66		67
	Outdoor Unit [dBA] (Cooling)	70		72
Size	Net Dimension (WxHxD)	Indoor Unit [mm]	1,300 x 300 x 700	
		Outdoor Unit [mm]	940 x 1,210 x 330	
	Shipping Dimension (WxHxD)	Indoor Unit [mm]	1,529 x 370 x 779	
		Outdoor Unit [mm]	995 x 1,388 x 426	
Weight	Net	Indoor Unit [kg]	44.0	
		Outdoor Unit [kg]	88.5	
	Gross	Indoor Unit [kg]	50.0	
		Outdoor Unit [kg]	98.0	
Harness Specifications	Indoor Fan Motor	DB31-00641B		DB31-00641B
	Compressor	UG5TK1450FJXSG		UG5TK1450FJXSG
	Outdoor Fan Motor	DB31-00579A		DB31-00579A
Piping	High Pressure	Φ9.52		Φ9.52
	Low Pressure	Φ15.88		Φ15.88
Refrigerant Type		R-410A		R-410A
Factory Charging [g]		3,400		3,400
Additional Refrigerant (Over 5m, for every 5m) [g]		30		30
Basic Piping Length [m]		7.5		7.5
Max. Piping Length [m]		75		75
Max. Level Difference [m]		30		30
Option Code		01B3FC-1C5943-277D8A-370045		01B3FC-1C5954-278C9B-370045
		020010-120000-200000-300000		020010-120000-200000-300000
		030000-100000-200000-300000		030000-100000-200000-300000
		050000-100000-200000-300000		050000-100000-200000-300000

## Product Specifications (cont.)





Item		Duct S			
		IN	AC018BNHDCH/AA	AC024BNHDCH/AA	AC030BNHDCH/AA
		OUT	AC018BXSCCC/AA	AC024BXSCCC/AA	AC030BXSCCC/AA
Design	Indoor Unit				
	Outdoor Unit				
	Remote Controller				
Performance	Cooling [Btu/h]		4,000 / 18,000 / 22,000	6,000 / 24,000 / 30,000	8,600 / 30,000 / 36,000
	Heating [Btu/h]		-	-	-
Power Consumption	Cooling [W]		270 / 1,570 / 2,200	350 / 2,200 / 3,840	650 / 2,910 / 4,600
	Heating [W]		-	-	-
EER/COP	Cooling [Btu/hW]		11.5	10.8	10.3
	Heating [W/W]		-	-	-
Voltage / Frequency			1,2,208-230,60	1,2,208-230,60	1,2,208-230,60
Operating Current	Cooling [A]		1.7 / 7.1 / 9.7	2.1 / 10.0 / 16.9	3.5 / 13.0 / 20.4
	Heating [A]		-	-	-
Sound Pressure	Indoor Unit [dBA] (H/M/L)		34/30/26	36/32/28	41/37/33
	Outdoor Unit [dBA] (C/H)		48/-	50/-	52/-
Sound Power	Indoor Unit [dBA] (Cooling)		56	58	63
	Outdoor Unit [dBA] (Cooling)		62	65	67
Size	Net Dimension (WxHxD)	Indoor Unit [mm]	1,200 x 250 x 700	1,200 x 250 x 700	1,200 x 250 x 700
		Outdoor Unit [mm]	880 x 638 x 310	880 x 798 x 310	940 x 998 x 330
	Shipping Dimension (WxHxD)	Indoor Unit [mm]	1,429 x 320 x 779	1,429 x 320 x 779	1,429 x 320 x 779
		Outdoor Unit [mm]	1,023 x 881 x 413	1,023 x 881 x 413	995 x 1,096 x 426
Weight	Net	Indoor Unit [kg]	34.9	35.0	35.0
		Outdoor Unit [kg]	40.5	52.5	71.0
	Gross	Indoor Unit [kg]	39.4	39.5	39.5
		Outdoor Unit [kg]	43.5	56.5	76.0
Harness Specifications	Indoor Fan Motor		DB31-00640B	DB31-00640B	DB31-00640B
	Compressor		UG9TK3150FE4SG	UG4T200FUAE4SG	UG8T300FUBJUSG
	Outdoor Fan Motor		DB31-00683A	DB31-00683A	DB31-00683A
Piping	High Pressure		Φ6.35	Φ6.35	Φ9.52
	Low Pressure		Φ12.7	Φ15.88	Φ15.88
Refrigerant Type			R-410A	R-410A	R-410A
Factory Charging [g]			1,300	2,000	2,400
Additional Refrigerant (over 7.5m) [g]			15	10	30
Basic Piping Length [m]			7.5	7.5	7.5
Max. Piping Length [m]			30	50	50
Max. Level Difference [m]			20	30	30
Option Code			01B3FC-1C5416-2F343C-370020	01B3FC-1C542A-27484F-370020	01B3FC-1C59B9-275A5E-370020
			020010-120000-200000-300000	020010-120000-200000-300000	020010-120000-200000-300000
			030000-100000-200000-300000	030000-100000-200000-300000	030000-100000-200000-300000
			050000-100000-200000-300000	050000-100000-200000-300000	050000-100000-200000-300000







## Product Specifications (cont.)

Item		Duct S			
		IN	AC036BNHDCH/AA	AC030BNHDCH/AA	AC036BNHDCH/AA
		OUT	AC036BXSCCH/AA	AC030BXSCCH/AA	AC036BXSCCH/AA
Design	Indoor Unit				
	Outdoor Unit				
	Remote Controller				
Performance	Cooling [Btu/h]		10,000 / 36,000 / 40,000	14,000 / 30,000 / 36,000	14,500 / 36,000 / 42,000
	Heating [Btu/h]		-	10,500 / 32,000 / 40,000	11,000 / 40,000 / 48,000
Power Consumption	Cooling [W]		750 / 3,790 / 4,800	850 / 2,500 / 3,300	870 / 2,950 / 4,000
	Heating [W]		-	680 / 2,840 / 4,700	770 / 3,350 / 5,300
EER/COP	Cooling [Btu/hW]		9.5	12.0	12.2
	Heating [W/W]		-	3.3	3.5
Voltage / Frequency		1,2,208-230,60			
Operating Current	Cooling [A]		3.4 / 16.8 / 21.3	4.5 / 11.4 / 14.5	4.7 / 13.2 / 17.7
	Heating [A]		-	3.6 / 13.0 / 20.6	4.2 / 15.0 / 23.3
Sound Pressure	Indoor Unit [dBA] (H/M/L)		43/40/38	41/37/33	43/40/38
	Outdoor Unit [dBA] (C/H)		54/-	49/50	49/51
Sound Power	Indoor Unit [dBA] (Cooling)		65	63	65
	Outdoor Unit [dBA] (Cooling)		69	67	69
Size	Net Dimension (WxHxD)	Indoor Unit [mm]	1,300 x 300 x 700	1,200 x 250 x 700	1,300 x 300 x 700
		Outdoor Unit [mm]	940 x 998 x 330	940 x 1,420 x 330	940 x 1,420 x 330
	Shipping Dimension (WxHxD)	Indoor Unit [mm]	1,529 x 370 x 779	1,429 x 320 x 779	1,529 x 370 x 779
		Outdoor Unit [mm]	995 x 1,096 x 426	995 x 1,598 x 426	995 x 1,598 x 426
Weight	Net	Indoor Unit [kg]	44.0	35.0	44.0
		Outdoor Unit [kg]	71.0	100.0	100.0
	Gross	Indoor Unit [kg]	50.0	39.5	50.0
		Outdoor Unit [kg]	76.0	110.0	110.0
Harness Specifications	Indoor Fan Motor		DB31-00692A	DB31-00640B	DB31-00692A
	Compressor		UG8T300FUBJUSG	ATQ420D1UNT1	ATQ420D1UNT1
	Outdoor Fan Motor		DB31-00683A	DB31-00579A	DB31-00579A
Piping	High Pressure		Φ9.52	Φ9.52	Φ9.52
	Low Pressure		Φ15.88	Φ15.88	Φ15.88
Refrigerant Type		R-410A			
Factory Charging [g]		2,400			
Additional Refrigerant (over 7.5m) [g]		30			
Basic Piping Length [m]		7.5			
Max. Piping Length [m]		50			
Max. Level Difference [m]		30			
Option Code		01B3FC-1C5933-276975-370045		01B3FC-1C59B9-275A5E-370020	01B3FC-1C5933-276975-370045
		020010-120000-200000-300000		020010-120000-200000-300000	020010-120000-200000-300000
		030000-100000-200000-300000		030000-100000-200000-300000	030000-100000-200000-300000
		050000-100000-200000-300000		050000-100000-200000-300000	050000-100000-200000-300000
		050000-100000-200000-300000		050000-100000-200000-300000	050000-100000-200000-300000





## Product Specifications (cont.)

Item		Console			
		IN	AC009BNJDCH	AC012BNJDCH	AC018BNJDCH
		OUT	AC009BXADCH	AC012BXADCH	AC018BXADCH
Design	Indoor Unit				
	Outdoor Unit				
	Remote Controller				
Performance	Cooling [Btu/h]	3,100/9,000/13,000	3,200/10,200/13,500	5,500/17,000/20,000	
	Heating [Btu/h]	2,700/10,100/18,500	2,800/13,000/19,000	4,000/19,000/21,000	
Power Consumption	Cooling [W]	180/720/1,410	180/850/1,420	370/1,700/2,320	
	Heating [W]	170/870/2,320	170/1,150/2,380	330/1,920/3,000	
EER/COP	Cooling [Btu/hW]	12.5	12.0	10.0	
	Heating [Btu/hW]	3.4	3.3	2.9	
Voltage / Frequency		1,2208-230,60	1,2208-230,60	1,2208-230,60	
Operating Current	Cooling [A]	1.2/3.6/6.3	1.2/4.0/6.3	2.2/7.7/10.3	
	Heating [A]	1.1/4.2/10.3	1.1/5.2/10.6	2.0/8.6/13.3	
Sound Pressure	Indoor Unit [dBA] (H/M/L/Silence)	35/31/29/24	38/35/33/24	43/39/35/32	
	Outdoor Unit [dBA] (C/H)	46/47	47/48	48/48	
Sound Power	Indoor Unit [dBA] (Cooling)	53	55	60	
	Outdoor Unit [dBA] (Cooling)	59	61	62	
Size	Net Dimension (WxHxD)	Indoor Unit [mm]	720 x 620 x 199	720 x 620 x 199	720 x 620 x 199
		Outdoor Unit [mm]	790 x 548 x 285	790 x 548 x 285	880 x 798 x 310
	Shipping Dimension (WxHxD)	Indoor Unit [mm]	805 x 297 x 705	805 x 297 x 705	805 x 297 x 705
		Outdoor Unit [mm]	913 x 622 x 371	913 x 622 x 371	1,023 x 881 x 413
Weight	Net	Indoor Unit [kg]	15.7	15.7	15.9
		Outdoor Unit [kg]	33.3	33.3	53.7
	Gross	Indoor Unit [kg]	20.0	20.0	20.2
		Outdoor Unit [kg]	35.6	35.6	57.7
Harness Specifications	Indoor Fan Motor		DB31-00517A	DB31-00517A	DB31-00517A
	Compressor		DB95-05762A	DB95-05762A	UG8T265FXAEW
	Outdoor Fan Motor		DB31-00642C	DB31-00642C	DB31-00579A
Piping	High Pressure		Φ6.35	Φ6.35	Φ6.35
	Low Pressure		Φ9.52	Φ9.52	Φ12.7
Refrigerant Type		R-410A	R-410A	R-410A	
Factory Charging [g]		1,150	1,150	2,000	
Additional Refrigerant (Over 5m, for every 5m) [g]		15	15	10	
Basic Piping Length [m]		7.5	7.5	7.5	
Max. Piping Length [m]		20	20	50	
Max. Level Difference [m]		15	15	30	
Option Code		0193FF-1930B6-271A23-370400	0193FF-1930D8-272328-370500	0193FF-19240A-20343A-370408	
		020010-100000-200000-300000	020010-100000-200000-300000	020010-100000-200000-300000	
		030000-100000-200000-300002	030000-100000-200000-300002	030000-100000-200000-300002	
		050000-100000-200000-300000	050000-100000-200000-300000	050000-100000-200000-300000	





## Product Specifications (cont.)

Item		CRAC			
		IN	AC018BNADCH	AC024BNADCH	
		OUT	AC018BXADCH	AC024BXADCH	
Design	Indoor Unit				
	Outdoor Unit				
	Remote Controller				
Performance	Cooling [Btu/h]	6,000/18,000/22,000		8,000/24,000/27,000	
	Heating [Btu/h]	3,300/20,000/28,000		7,000/27,000/40,000	
Power Consumption	Cooling [W]	380/1,500/2,190		490/2,330/2,900	
	Heating [W]	300/1,830/4,550		380/2,730/5,300	
EER/COP	Cooling [Btu/hW]	12.0		10.3	
	Heating [Btu/hW]	3.2		2.9	
Voltage / Frequency		1,2,208-230,60		1,2,208-230,60	
Operating Current	Cooling [A]	2.1/6.9/9.7		2.5/10.6/12.9	
	Heating [A]	1.8/8.3/20.0		2.0/12.4/23.5	
Sound Pressure	Indoor Unit [dBA] (H/M/L/Silence)	42/37/32/29		44/39/35/30	
	Outdoor Unit [dBA] (C/H)	48/48		50/52	
Sound Power	Indoor Unit [dBA] (Cooling)	60		61	
	Outdoor Unit [dBA] (Cooling)	62		65	
Size	Net Dimension (WxHxD)	Indoor Unit [mm]	1,055 x 215 x 299		1,055 x 215 x 299
		Outdoor Unit [mm]	880 x 798 x 310		940 x 998 x 330
	Shipping Dimension (WxHxD)	Indoor Unit [mm]	1,115 x 290 x 375		1,115 x 290 x 375
		Outdoor Unit [mm]	1,023 x 881 x 413		995 x 1,096 x 426
Weight	Net	Indoor Unit [kg]	11.7		12.7
		Outdoor Unit [kg]	53.7		72.0
	Gross	Indoor Unit [kg]	13.5		14.7
		Outdoor Unit [kg]	57.7		77.0
Harness Specifications	Indoor Fan Motor		DB31-00636A		DB31-00637A
	Compressor		UG8T265FXAEW		UG8T300FUBJUSG
	Outdoor Fan Motor		DB31-00579A		DB31-00579A
Piping	High Pressure		Φ6.35		Φ6.35
	Low Pressure		Φ12.7		Φ15.88
Refrigerant Type		R-410A		R-410A	
Factory Charging [g]		2,000		2,600	
Additional Refrigerant (Over 5m, for every 5m) [g]		10		30	
Basic Piping Length [m]		7.5		7.5	
Max. Piping Length [m]		50		50	
Max. Level Difference [m]		30		30	
Option Code		0112FF-19542B-2A343B-371440		0112FF-19345E-27484F-371540	
		020010-100011-200000-300000		020010-100041-200000-300000	
		030000-100000-200000-300000		030000-100000-200000-300000	
		050000-100000-200000-300000		050000-100000-200000-300000	



## Product Specifications (cont.)

Item		CRAC		
		IN	AC018BNADCH/AA	AC024BNADCH/AA
		OUT	AC018BXSCCC/AA	AC024BXSCCC/AA
Design	Indoor Unit			
	Outdoor Unit			
	Remote Controller			
Performance	Cooling [Btu/h]		4,000 / 18,000 / 20,000	6,000 / 24,000 / 27,000
	Heating [Btu/h]		-	-
Power Consumption	Cooling [W]		230 / 1,500 / 2,420	330 / 2,500 / 3,500
	Heating [W]		-	-
EER/COP	Cooling [Btu/hW]		12	9.6
	Heating [W/W]		-	-
Voltage / Frequency		1,2,208-230,60	1,2,208-230,60	
Operating Current	Cooling [A]		1.4 / 6.8 / 10.6	2.0 / 11.1 / 15.4
	Heating [A]		-	-
Sound Pressure	Indoor Unit [dBA] (H/M/L/Silence)		42/37/32/29	44/39/35/30
	Outdoor Unit [dBA] (C/H)		48/-	50/-
Sound Power	Indoor Unit [dBA] (Cooling)		60	61
	Outdoor Unit [dBA] (Cooling)		62	65
Size	Net Dimension (WxHxD)	Indoor Unit [mm]	1,055 x 215 x 299	1,055 x 215 x 299
		Outdoor Unit [mm]	880 x 638 x 310	880 x 798 x 310
	Shipping Dimension (WxHxD)	Indoor Unit [mm]	1,115 x 290 x 375	1,115 x 290 x 375
		Outdoor Unit [mm]	1,023 x 881 x 413	1,023 x 881 x 413
Weight	Net	Indoor Unit [kg]	11.7	12.7
		Outdoor Unit [kg]	40.5	52.5
	Gross	Indoor Unit [kg]	13.5	14.7
		Outdoor Unit [kg]	43.5	56.5
Harness Specifications	Indoor Fan Motor		DB31-00636A	DB31-00637A
	Compressor		UG9TK3150FE4SG	UG4T200FUAE4SG
	Outdoor Fan Motor		DB31-00683A	DB31-00683A
Piping	High Pressure		Φ6.35	Φ6.35
	Low Pressure		Φ12.7	Φ15.88
Refrigerant Type		R-410A	R-410A	
Factory Charging [g]		1,300	2,000	
Additional Refrigerant (over 7.5m) [g]		15	10	
Basic Piping Length [m]		7.5	7.5	
Max. Piping Length [m]		30	50	
Max. Level Difference [m]		20	30	
Option Code		0112FF-19542B-2A343B-371440	0112FF-19345E-27484F-371540	
		020010-100011-200000-300000	020010-100041-200000-300000	
		030000-100000-200000-300000	030000-100000-200000-300000	
		050000-100000-200000-300000	050000-100000-200000-300000	





## Product Specifications (cont.)

Item		CRAC		
		IN	AC030BNTDCH	AC036BNTDCH
		OUT	AC030BXADCH	AC036BXADCH
Design	Indoor Unit			
	Outdoor Unit			
	Remote Controller			
Performance	Cooling [Btu/h]		8,500/30,000/33,000	11,000/36,000/39,000
	Heating [Btu/h]		7,200/32,000/42,000	9,500/40,000/47,000
Power Consumption	Cooling [W]		500/3,030/3,850	900/3,790/4,300
	Heating [W]		410/3,350/5,400	560/4,510/5,820
EER/COP	Cooling [Btu/hW]		9.9	9.5
	Heating [Btu/hW]		2.8	2.6
Voltage / Frequency		1,2208-230,60	1,2208-230,60	
Operating Current	Cooling [A]		2.5/13.6/17.1	5.0/16.8/19.1
	Heating [A]		2.1/15.0/24.0	3.0/20.0/24.0
Sound Pressure	Indoor Unit [dBA] (H/M/L/Silence)		49/47/45/37	51/48/46/38
	Outdoor Unit [dBA] (C/H)		50/52	52/54
Sound Power	Indoor Unit [dBA] (Cooling)		63	65
	Outdoor Unit [dBA] (Cooling)		67	69
Size	Net Dimension (WxHxD)	Indoor Unit [mm]	1,280 x 253 x 345	1,280 x 253 x 345
		Outdoor Unit [mm]	940 x 998 x 330	940 x 1,210 x 330
	Shipping Dimension (WxHxD)	Indoor Unit [mm]	1,352 x 326 x 420	1,352 x 326 x 420
		Outdoor Unit [mm]	995 x 1,096 x 426	995 x 1,388 x 426
Weight	Net	Indoor Unit [kg]	18.5	18.5
		Outdoor Unit [kg]	72.0	86.0
	Gross	Indoor Unit [kg]	22.0	22.0
		Outdoor Unit [kg]	77.0	95.5
Harness Specifications	Indoor Fan Motor		DB31-00332C	DB31-00332C
	Compressor		UG8T300FUBJUSG	UG5TK1450FJXSG
	Outdoor Fan Motor		DB31-00579A	DB31-00579A
Piping	High Pressure		Φ9.52	Φ9.52
	Low Pressure		Φ15.88	Φ15.88
Refrigerant Type		R-410A	R-410A	
Factory Charging [g]		2,600	2,900	
Additional Refrigerant (Over 5m, for every 5m) [g]		30	30	
Basic Piping Length [m]		7.5	7.5	
Max. Piping Length [m]		50	75	
Max. Level Difference [m]		30	30	
Option Code		0113FF-193572-275A5E-371700	0113FF-194593-276975-371700	
		020010-100000-200000-300000	020010-100000-200000-300000	
		030000-100000-200000-300000	030000-100000-200000-300000	
		050000-100000-200000-300000	050000-100000-200000-300000	



## Product Specifications (cont.)

Item		CRAC			
		IN	AC030BNTDCH/AA	AC036BNTDCH/AA	
		OUT	AC030BXSCCC/AA	AC036BXSCCC/AA	
Design	Indoor Unit				
	Outdoor Unit				
	Remote Controller				
Performance	Cooling [Btu/h]	8,500 / 30,000 / 35,000		10,000 / 36,000 / 38,000	
	Heating [Btu/h]	-		-	
Power Consumption	Cooling [W]	500 / 2,940 / 4,600		600 / 4,440 / 4,800	
	Heating [W]	-		-	
EER/COP	Cooling [Btu/hW]	10.2		8.1	
	Heating [W/W]	-		-	
Voltage / Frequency		1,2,208-230,60		1,2,208-230,60	
Operating Current	Cooling [A]	3.3 / 13.0 / 20.2		4.1 / 19.5 / 21.1	
	Heating [A]	-		-	
Sound Pressure	Indoor Unit [dBA] (H/M/L/Silence)	49/47/45/37		51/48/46/38	
	Outdoor Unit [dBA] (C/H)	52/-		54/-	
Sound Power	Indoor Unit [dBA] (Cooling)	63		65	
	Outdoor Unit [dBA] (Cooling)	67		69	
Size	Net Dimension (WxHxD)	Indoor Unit [mm]	1,280 x 253 x 345		1,280 x 253 x 345
		Outdoor Unit [mm]	940 x 998 x 330		940 x 998 x 330
	Shipping Dimension (WxHxD)	Indoor Unit [mm]	1,352 x 326 x 420		1,352 x 326 x 420
		Outdoor Unit [mm]	995 x 1,096 x 426		995 x 1,096 x 426
Weight	Net	Indoor Unit [kg]	18.5		18.5
		Outdoor Unit [kg]	71.0		71.0
	Gross	Indoor Unit [kg]	22		22
		Outdoor Unit [kg]	76.0		76.0
Harness Specifications	Indoor Fan Motor		DB31-00332C		DB31-00332C
	Compressor		UG8T300FUBJUSG		UG8T300FUBJUSG
	Outdoor Fan Motor		DB31-00683A		DB31-00683A
Piping	High Pressure		Φ9.52		Φ9.52
	Low Pressure		Φ15.88		Φ15.88
Refrigerant Type		R-410A		R-410A	
Factory Charging [g]		2,400		2,400	
Additional Refrigerant (over 7.5m) [g]		30		30	
Basic Piping Length [m]		7.5		7.5	
Max. Piping Length [m]		50		50	
Max. Level Difference [m]		30		30	
Option Code		0113FF-193572-275A5E-371700		0113FF-194593-276975-371700	
		020010-100000-200000-300000		020010-100000-200000-300000	
		030000-100000-200000-300000		030000-100000-200000-300000	
		050000-100000-200000-300000		050000-100000-200000-300000	

## Product Specifications (cont.)





Item		MPAH			
		IN	AC018BNZDCH	AC024BNZDCH	AC030BNZDCH
		OUT	AC018BXADCH	AC024BXADCH	AC030BXADCH
Design	Indoor Unit				
	Outdoor Unit				
	Remote Controller				
Performance	Cooling [Btu/h]	5,000/18,000/22,000	8,000/24,000/30,000	8,500/30,000/34,000	
	Heating [Btu/h]	5,000/20,000/29,000	7,000/27,000/35,000	7,200/32,000/37,000	
Power Consumption	Cooling [W]	490/1,730/2,600	650/2,470/3,270	650/3,160/4,160	
	Heating [W]	430/1,890/4,510	530/2,830/5,300	540/3,130/5,300	
EER/COP	Cooling [Btu/hW]	10.4	9.7	9.5	
	Heating [W/W]	3.1	2.8	3.0	
Voltage / Frequency		1,2208-230,60	1,2208-230,60	1,2208-230,60	
Operating Current	Cooling [A]	3.0/7.9/11.5	4.3/11.2/14.5	4.6/14.2/18.5	
	Heating [A]	2.6/8.6/20.0	3.5/12.7/24.0	3.6/14.0/24.0	
Sound Pressure	Indoor Unit [dBA] (H/M/L)	40/37/34	41/38/35	41/38/35	
	Outdoor Unit [dBA] (C/H)	48/48	50/52	50/52	
Sound Power	Indoor Unit [dBA] (Cooling)	58	59	59	
	Outdoor Unit [dBA] (Cooling)	63	64	65	
Size	Net Dimension (WxHxD)	Indoor Unit [mm]	445 x 1,092 x 533	445 x 1,092 x 533	533 x 1,219 x 533
		Outdoor Unit [mm]	880 x 798 x 310	940 x 998 x 330	940 x 998 x 330
	Shipping Dimension (WxHxD)	Indoor Unit [mm]	493 x 1,135 x 665	493 x 1,135 x 665	590 x 1,305 x 665
		Outdoor Unit [mm]	1,023 x 881 x 413	995 x 1,096 x 426	995 x 1,096 x 426
Weight	Net	Indoor Unit [kg]	44.5	44.5	57.0
		Outdoor Unit [kg]	53.7	72.0	72.0
	Gross	Indoor Unit [kg]	49.0	49.0	62.5
		Outdoor Unit [kg]	57.7	77.0	77.0
Harness Specifications	Indoor Fan Motor	DB81-04294H	DB81-04294J	DB81-04294K	
	Compressor	UG8T265FXAEW	UG8T300FUBJUSG	UG8T300FUBJUSG	
	Outdoor Fan Motor	DB31-00579A	DB31-00579A	DB31-00579A	
Piping	High Pressure	Φ6.35	Φ6.35	Φ9.52	
	Low Pressure	Φ12.7	Φ15.88	Φ15.88	
Refrigerant Type		R-410A	R-410A	R-410A	
Factory Charging [g]		2,000	2,600	2,600	
Additional Refrigerant (over 7.5m) [g]		10	30	30	
Basic Piping Length [m]		7.5	7.5	7.5	
Max. Piping Length [m]		50	50	50	
Max. Level Difference [m]		30	30	30	
Option Code		01E2FC-105020-2F343C-370000	01E2FC-105020-27484F-370000	01E2FC-105020-275A5E-370000	
		020010-100000-200000-300000	020010-100000-200000-300000	020010-100000-200000-300000	
		030000-100000-200000-300002	030000-100000-200000-300002	030000-100000-200000-300000	
		050000-100000-200000-300000	050000-100000-200000-300000	050000-100000-200000-300000	

## Product Specifications (cont.)



Item		MPAH			
		IN	AC036BNZDCH	AC042BNZDCH	AC048BNZDCH
		OUT	AC036BXADCH	AC042BXADCH	AC048BXADCH
Design	Indoor Unit				
	Outdoor Unit				
	Remote Controller				
Performance	Cooling [Btu/h]	10,000/36,000/37,000	12,000/42,000/46,000	12,500/48,000/52,000	
	Heating [Btu/h]	10,000/40,000/50,000	10,500/47,000/60,000	11,000/53,000/63,000	
Power Consumption	Cooling [W]	920/3,750/4,880	940/4,420/5,600	970/5,450/6,690	
	Heating [W]	800/3,910/6,090	810/4,920/7,400	820/5,550/7,670	
EER/COP	Cooling [Btu/hW]	9.6	9.5	8.8	
	Heating [W/W]	3.0	2.8	2.8	
Voltage / Frequency		1,2208-230,60	1,2208-230,60	1,2208-230,60	
Operating Current	Cooling [A]	5.0/16.8/21.7	5.1/19.8/24.8	5.1/24.2/29.4	
	Heating [A]	4.3/17.5/24.0	4.4/22.1/32.0	4.4/24.6/32.0	
Sound Pressure	Indoor Unit [dBA] (H/M/L)	45/42/39	46/43/40	47/45/43	
	Outdoor Unit [dBA] (C/H)	52/54	53/55	56/58	
Sound Power	Indoor Unit [dBA] (Cooling)	63	64	65	
	Outdoor Unit [dBA] (Cooling)	69	70	72	
Size	Net Dimension (WxHxD)	Indoor Unit [mm]	533 x 1,219 x 533	622 x 1,492 x 553	622 x 1,492 x 553
		Outdoor Unit [mm]	940 x 1,210 x 330	940 x 1,210 x 330	940 x 1,210 x 330
	Shipping Dimension (WxHxD)	Indoor Unit [mm]	590 x 1,305 x 665	676 x 1,588 x 695	676 x 1,588 x 695
		Outdoor Unit [mm]	995 x 1,388 x 426	995 x 1,388 x 426	995 x 1,388 x 426
Weight	Net	Indoor Unit [kg]	57.0	75.5	75.5
		Outdoor Unit [kg]	86.0	88.5	88.5
	Gross	Indoor Unit [kg]	62.5	81.5	81.5
		Outdoor Unit [kg]	95.5	98.0	98.0
Harness Specifications	Indoor Fan Motor	DB81-04294L	DB81-04294M	DB81-04294N	
	Compressor	UG5TK1450FJXSG	UG5TK1450FJXSG	UG5TK1450FJXSG	
	Outdoor Fan Motor	DB31-00579A	DB31-00579A	DB31-00579A	
Piping	High Pressure	Φ9.52	Φ9.52	Φ9.52	
	Low Pressure	Φ15.88	Φ15.88	Φ15.88	
Refrigerant Type		R-410A	R-410A	R-410A	
Factory Charging [g]		2,900	3,400	3,400	
Additional Refrigerant (over 7.5m) [g]		30	30	30	
Basic Piping Length [m]		7.5	7.5	7.5	
Max. Piping Length [m]		75	75	75	
Max. Level Difference [m]		30	30	30	
Option Code		01E2FC-105020-276975-370005	01E2FC-105020-277D89-37000D	01E2FC-105020-278C9B-37000D	
		020010-100000-200000-300000	020010-100000-200000-300000	020010-100000-200000-300000	
		030000-100000-200000-300000	030000-100000-200000-300000	030000-100000-200000-300000	
		050000-100000-200000-300000	050000-100000-200000-300000	050000-100000-200000-300000	





## Product Specifications (cont.)

Item		MPAH			
		IN	AC018KNZDCH/AA	AC024KNZDCH/AA	AC030KNZDCH/AA
		OUT	AC018BXADCH/AA	AC024BXADCH/AA	AC030BXADCH/AA
Design	Indoor Unit				
	Outdoor Unit				
	Remote Controller				
Performance	Cooling [Btu/h]	5,000 / 18,000 / 22,000	8,000 / 24,000 / 30,000	8,500 / 30,000 / 34,000	
	Heating [Btu/h]	5,000 / 20,000 / 29,000	7,000 / 27,000 / 35,000	7,200 / 32,000 / 37,000	
Power Consumption	Cooling [W]	490 / 1,500 / 2,600	650 / 2,180 / 3,270	650 / 2,800 / 4,160	
	Heating [W]	430 / 1,890 / 4,510	530 / 2,830 / 5,300	540 / 3,130 / 5,300	
EER/COP	Cooling [Btu/hW]	12.00	11.00	10.70	
	Heating [W/W]	3.10	2.80	3.00	
Voltage / Frequency		1,2,208-230,60	1,2,208-230,60	1,2,208-230,60	
Operating Current	Cooling [A]	3.0 / 6.9 / 11.5	4.3 / 9.9 / 14.5	4.6 / 12.6 / 18.5	
	Heating [A]	2.6 / 8.6 / 20.0	3.5 / 12.8 / 24.0	3.6 / 14.0 / 24.0	
Sound Pressure	Indoor Unit [dBA] (H/M/L)	38/35/32	41/38/35	41/38/35	
	Outdoor Unit [dBA] (C/H)	48/48	50/52	50/52	
Sound Power	Indoor Unit [dBA] (Cooling)	56	59	59	
	Outdoor Unit [dBA] (Cooling)	62	65	67	
Size	Net Dimension (WxHxD)	Indoor Unit [mm]	445 x 1,092 x 533	445 x 1,092 x 533	533 x 1,219 x 533
		Outdoor Unit [mm]	880 x 798 x 310	940 x 998 x 330	940 x 998 x 330
	Shipping Dimension (WxHxD)	Indoor Unit [mm]	493 x 1,135 x 665	493 x 1,135 x 665	590 x 1,305 x 665
		Outdoor Unit [mm]	1,023 x 881 x 413	995 x 1,096 x 426	995 x 1,096 x 426
Weight	Net	Indoor Unit [kg]	44.5	44.5	57.0
		Outdoor Unit [kg]	53.7	72.0	72.0
	Gross	Indoor Unit [kg]	49.0	49.0	62.5
		Outdoor Unit [kg]	57.7	77.0	77.0
Harness Specifications	Indoor Fan Motor	DB81-04294A	DB81-04294B	DB81-04294C	
	Compressor	UG8T265FXAEW	UG8T300FUBJUSG	UG8T300FUBJUSG	
	Outdoor Fan Motor	DB31-00579A	DB31-00579A	DB31-00579A	
Piping	High Pressure	Φ6.35	Φ6.35	Φ9.52	
	Low Pressure	Φ12.7	Φ15.88	Φ15.88	
Refrigerant Type		R-410A	R-410A	R-410A	
Factory Charging [g]		2,000	2,600	2,600	
Additional Refrigerant (over 7.5m) [g]		10	30	30	
Basic Piping Length [m]		7.5	7.5	7.5	
Max. Piping Length [m]		75	75	50	
Max. Level Difference [m]		30	30	30	
Option Code		01E06C-105020-27343B-370005	01E06C-105020-274750-370005	01E06C-105020-275A64-370005	
		020000-100000-200000-300000	020000-100000-200000-300000	020000-100000-200000-300000	
		030000-100000-200000-300000	030000-100000-200000-300000	030000-100000-200000-300000	
		050000-100000-200000-300000	050000-100000-200000-300000	050000-100000-200000-300000	



## Product Specifications (cont.)

Item		MPAH			
		IN	AC036KNZDCH/AA	AC042KNZDCH/AA	AC048KNZDCH/AA
		OUT	AC036BXADCH/AA	AC042BXADCH/AA	AC048BXADCH/AA
Design	Indoor Unit				
	Outdoor Unit				
	Remote Controller				
Performance	Cooling [Btu/h]	10,000 / 36,000 / 37,000	12,000 / 42,000 / 46,000	12,500 / 48,000 / 52,000	
	Heating [Btu/h]	10,000 / 40,000 / 50,000	10,500 / 47,000 / 60,000	11,000 / 53,000 / 63,000	
Power Consumption	Cooling [W]	920 / 3,600 / 4,880	940 / 4,140 / 5,600	970 / 5,220 / 6,690	
	Heating [W]	800 / 3,640 / 6,090	810 / 4,590 / 7,400	820 / 5,180 / 7,670	
EER/COP	Cooling [Btu/hW]	10.00	10.15	9.20	
	Heating [W/W]	3.22	3.00	3.00	
Voltage / Frequency		1,2208-230,60	1,2208-230,60	1,2208-230,60	
Operating Current	Cooling [A]	5.0 / 16.1 / 21.7	5.1 / 18.6 / 24.8	5.1 / 23.4 / 29.4	
	Heating [A]	4.3 / 16.3 / 24.0	4.4 / 20.6 / 32.0	4.4 / 23.2 / 32.0	
Sound Pressure	Indoor Unit [dBA] (H/M/L)	42/39/36	42/39/36	43/41/38	
	Outdoor Unit [dBA] (C/H)	52/54	53/55	56/58	
Sound Power	Indoor Unit [dBA] (Cooling)	60	60	61	
	Outdoor Unit [dBA] (Cooling)	69	70	72	
Size	Net Dimension (WxHxD)	Indoor Unit [mm]	533 x 1,219 x 533	622 x 1,492 x 553	622 x 1,492 x 553
		Outdoor Unit [mm]	940 x 1,210 x 330	940 x 1,210 x 330	940 x 1,210 x 330
	Shipping Dimension (WxHxD)	Indoor Unit [mm]	590 x 1,305 x 665	676 x 1,588 x 695	676 x 1,588 x 695
		Outdoor Unit [mm]	995 x 1,388 x 426	995 x 1,388 x 426	995 x 1,388 x 426
Weight	Net	Indoor Unit [kg]	57.0	75.5	75.5
		Outdoor Unit [kg]	86.0	88.5	88.5
	Gross	Indoor Unit [kg]	62.5	81.5	81.5
		Outdoor Unit [kg]	95.5	98.0	98.0
Harness Specifications	Indoor Fan Motor		DB81-04294D	DB81-04294E	DB81-04294F
	Compressor		UG5TK1450FJXSG	UG5TK1450FJXSG	UG5TK1450FJXSG
	Outdoor Fan Motor		DB31-00579A	DB31-00579A	DB31-00579A
Piping	High Pressure		Φ9.52	Φ9.52	Φ9.52
	Low Pressure		Φ15.88	Φ15.88	Φ15.88
Refrigerant Type		R-410A	R-410A	R-410A	
Factory Charging [g]		2,900	3,400	3,400	
Additional Refrigerant (over 7.5m) [g]		30	30	30	
Basic Piping Length [m]		7.5	7.5	7.5	
Max. Piping Length [m]		50	50	75	
Max. Level Difference [m]		30	30	30	
Option Code		01E06C-105020-276470-370005	01E06C-105020-277D8C-370005	01E06C-105020-278CA0-370005	
		020000-100000-200000-300000	020000-100000-200000-300000	020000-100000-200000-300000	
		030000-100000-200000-300000	030000-100000-200000-300000	030000-100000-200000-300000	
		050000-100000-200000-300000	050000-100000-200000-300000	050000-100000-200000-300000	

## Product Specifications (cont.)

Item		MPAH		
		IN	AC030KNZDCH/AA	AC036KNZDCH/AA
		OUT	AC030BXSCCH/AA	AC036BXSCCH/AA
Design	Indoor Unit			
	Outdoor Unit			
	Remote Controller			
Performance	Cooling [Btu/h]	13,000 / 30,000 / 36,000	13,500 / 36,000 / 42,000	
	Heating [Btu/h]	10,000 / 32,000 / 40,000	10,500 / 40,000 / 45,000	
Power Consumption	Cooling [W]	870 / 2,290 / 3,300	900 / 2,930 / 4,100	
	Heating [W]	720 / 2,730 / 4,700	760 / 3,530 / 5,000	
EER/COP	Cooling [Btu/hW]	13.10	12.30	
	Heating [W/W]	3.44	3.32	
Voltage / Frequency		1,2,208-230,60	1,2,208-230,60	
Operating Current	Cooling [A]	4.6 / 10.5 / 14.5	4.9 / 13.1 / 18.0	
	Heating [A]	3.9 / 12.5 / 20.6	4.0 / 15.8 / 22.0	
Sound Pressure	Indoor Unit [dBA] (H/M/L)	41/38/35	42/39/36	
	Outdoor Unit [dBA] (C/H)	49/50	49/51	
Sound Power	Indoor Unit [dBA] (Cooling)	59	60	
	Outdoor Unit [dBA] (Cooling)	67	69	
Size	Net Dimension (WxHxD)	Indoor Unit [mm]	533 x 1,219 x 533	533 x 1,219 x 533
		Outdoor Unit [mm]	940 x 1,420 x 330	940 x 1,420 x 330
	Shipping Dimension (WxHxD)	Indoor Unit [mm]	590 x 1,305 x 665	590 x 1,305 x 665
		Outdoor Unit [mm]	995 x 1,598 x 426	995 x 1,598 x 426
Weight	Net	Indoor Unit [kg]	57.0	57.0
		Outdoor Unit [kg]	100.0	100.0
	Gross	Indoor Unit [kg]	62.5	62.5
		Outdoor Unit [kg]	110.0	110.0
Harness Specifications	Indoor Fan Motor		DB81-04294C	DB81-04294D
	Compressor		ATQ420D1UNT1	ATQ420D1UNT1
	Outdoor Fan Motor		DB31-00579A	DB31-00579A
Piping	High Pressure		Φ9.52	Φ9.52
	Low Pressure		Φ15.88	Φ15.88
Refrigerant Type		R-410A	R-410A	
Factory Charging [g]		4,000	4,000	
Additional Refrigerant (over 7.5m) [g]		30	30	
Basic Piping Length [m]		7.5	7.5	
Max. Piping Length [m]		75	75	
Max. Level Difference [m]		30	30	
Option Code		01E06C-105020-275A64-370005	01E06C-105020-276470-370005	
		020000-100000-200000-300000	020000-100000-200000-300000	
		030000-100000-200000-300000	030000-100000-200000-300000	
		050000-100000-200000-300000	050000-100000-200000-300000	

## Product Specifications (cont.)

Item		MPAH			
		IN	AC030BNZDCH/AA	AC036BNZDCH/AA	
		OUT	AC030BXSCH/AA	AC036BXSCH/AA	
Design	Indoor Unit				
	Outdoor Unit				
	Remote Controller				
Performance	Cooling [Btu/h]	13,000 / 30,000 / 36,000		13,500 / 36,000 / 42,000	
	Heating [Btu/h]	10,000 / 34,000 / 40,000		10,500 / 40,000 / 45,000	
Power Consumption	Cooling [W]	870 / 2,400 / 3,300		900 / 3,130 / 4,100	
	Heating [W]	720 / 3,020 / 4,700		760 / 4,100 / 5,000	
EER/COP	Cooling [Btu/hW]	12.5		11.5	
	Heating [W/W]	3.3		3.2	
Voltage / Frequency		1,2,208-230,60		1,2,208-230,60	
Operating Current	Cooling [A]	4.6 / 10.9 / 14.5		4.9 / 13.9 / 18.0	
	Heating [A]	3.9 / 13.5 / 20.6		4.0 / 16.4 / 22.0	
Sound Pressure	Indoor Unit [dBA] (H/M/L)	41/38/35		45/42/39	
	Outdoor Unit [dBA] (C/H)	49/50		49/51	
Sound Power	Indoor Unit [dBA] (Cooling)	59		63	
	Outdoor Unit [dBA] (Cooling)	67		69	
Size	Net Dimension (WxHxD)	Indoor Unit [mm]	533 x 1,219 x 533		533 x 1,219 x 533
		Outdoor Unit [mm]	940 x 1,420 x 330		940 x 1,420 x 330
	Shipping Dimension (WxHxD)	Indoor Unit [mm]	590 x 1,305 x 665		590 x 1,305 x 665
		Outdoor Unit [mm]	995 x 1,598 x 426		995 x 1,598 x 426
Weight	Net	Indoor Unit [kg]	57		57
		Outdoor Unit [kg]	100		100
	Gross	Indoor Unit [kg]	62.5		62.5
		Outdoor Unit [kg]	110		110
Harness Specifications	Indoor Fan Motor		DB81-04294K	DB81-04294L	
	Compressor		ATQ420D1UNT1	ATQ420D1UNT1	
	Outdoor Fan Motor		DB31-00579A	DB31-00579A	
Piping	High Pressure		Φ9.52	Φ9.52	
	Low Pressure		Φ15.88	Φ15.88	
Refrigerant Type		R-410A		R-410A	
Factory Charging [g]		4,000		4,000	
Additional Refrigerant (over 7.5m) [g]		30		30	
Basic Piping Length [m]		7.5		7.5	
Max. Piping Length [m]		75		75	
Max. Level Difference [m]		30		30	
Option Code		01E2FC-105020-275A5E-370000		01E2FC-105020-276975-370005	
		020010-100000-200000-300000		020010-100000-200000-300000	
		030000-100000-200000-300000		030000-100000-200000-300000	
		050000-100000-200000-300000		050000-100000-200000-300000	

## 2-6. Specifications of optional items







### 2-6-1. Accessories

#### ■ AC\*\*\*BN4DCH

Item	Description	Code No.	Q'ty	Remark
	ASSY DRAIN-HOSE	DB94-02719B	1	Indoor Unit
	CABLE TIE	DB65-00191A	6	
	SEAL-DRAIN ASSY	DB62-05810A	1	
	SEAL-DRAIN ASSY	DB62-05810F	1	
	SEAL-DRAIN ASSY	DB62-05810G	1	
	CARD WARRANTY	6801-002246	1	
	MANUAL USERS	DB68-11305A	1	
	MANUAL INSTALL	DB68-11272A	1	
	BRACKET-CONDUIT	DB61-05788A	1	
	HOLDER-HOSE	DB61-06904A	1	

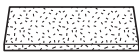
## Accessories (cont.)

### ■ AC\*\*\*BN1DCH

Item	Description	Code No.	Q'ty		Remark
			AC009BN1DCH AC012BN1DCH	AC018BN1DCH	
	PAD INSTALL	DB69-01947A,B	1	-	Indoor Unit
		DB69-03017C,D	-	1	
	SEAL-DRAIN ASSY	DB62-05810A	1	1	
	HOSE DRAIN-JOINT	DB94-01258C	1	1	
	GROMMET-HANGER	DB63-00237A	8	8	
	MANUAL USERS	DB68-11305A	1	1	
	MANUAL INSTALL	DB68-11272A	1	1	
	INSULATION-BASE	DB72-00401C	2	2	
	CABLE TIE	DB65-10088C	3	3	
	CARD WARRANTY	6801-002246	1	1	
	BRACKET-BUSHING	DB61-04340A	1	-	
	BRACKET-HOLDER	DB61-07701A	-	1	
	HOLDER-HOSE	DB61-06904A	1	1	

## Accessories (cont.)

### ■ AC\*\*\*BNDCH

Item	Description	Code No.	Q'ty	Remark
	ASSY DRAIN-HOSE	DB94-03287A	1	Indoor Unit
	CABLE TIE	DB65-10088C	6	
	SEAL-DRAIN ASSY	DB62-11028A	1	
	SEAL-DRAIN ASSY	DB62-11028H	1	
	SEAL-DRAIN ASSY	DB62-11028J	1	
	MANUAL USERS	DB68-11208A	1	
	MANUAL INSTALL	DB68-11209A	1	
	CARD WARRANTY	6801-002246	1	
	BRACKET-CONDUIT	DB61-05788A	1	
	HOLDER-HOSE	DB61-06904A	1	

## Accessories (cont.)







■ AC\*\*\*BNLDCH, AC\*\*\*BNHDCH

Item	Description	Code No.	Q'ty	Remark
	MANUAL USERS	DB68-11206A	1	Indoor Unit
	MANUAL INSTALL	DB68-11207A	1	
	INSULATION-COVER BAND	DB62-04318S	1	
	INSULATION-HOSE	DB62-11028M	1	
	INSULATION-HOSE D	DB62-11028E	1	
	ASSY DRAIN HOSE	DB62-11028F	1	
	INSULATION-TUBE OUT	DB94-06964B	1	
	GROMMET-HANGER	DB63-00237A	4	
	CARD WARRANTY	6801-002246	1	
	CABLE TIE	6501-001110	8	
	HOLDER-HOSE	DB61-06904A	1	



## Accessories (cont.)

■ AC\*\*\*BNADCH, AC\*\*\*BNTDCH

Item	Description	Code No.	Q'ty		Remark
			AC***BNADCH	AC***BNTDCH	
	ASSY WIRELESS REMOCON	DB96-24901P	1	1	Indoor Unit
	BATTERY-MN	4301-000121	2	2	
	MANUAL USERS	DB68-11176A	1	-	
		DB68-11210A	-	1	
	MANUAL INSTALL	DB68-11178A	1	-	
		DB68-11211A	-	1	
	HOLDER-REMOCON	DB61-06087A	1	1	
	SCREW-TAPPING (M4*L12)	6002-000213	2	2	
	CARD WARRNATY	6801-002246	1	1	

## Accessories (cont.)

### ■ AC\*\*\*BN6DCH

Item	Description	Code No.	Q'ty	Remark
	ASSY DRAIN-HOSE	DB94-02719B	1	Indoor Unit
	CABLE TIE	DB65-00191A	6	
	SEAL-DRAIN ASSY	DB62-05810A	1	
	SEAL-DRAIN ASSY	DB62-05810F	1	
	SEAL-DRAIN ASSY	DB62-05810G	1	
	MANUAL USERS	DB68-11306A	1	
	MANUAL INSTALL	DB68-11273A	1	
	CARD WARRANTY	6801-002246	1	
	BRACKET-CONDUIT	DB61-05788A	1	
	HOLDER-HOSE	DB61-06904A	1	



## Accessories (cont.)

■ AC\*\*\*BNJDCH

Item	Description	Code No.	Q'ty	Remark
	ASSY WIRELESS REMOCON	DB96-24901P	1	Essential Offer (Indoor Unit)
	BATTERY-MN	4301-000121	2	
	MANUAL USERS	DB68-11212A	1	
	MANUAL INSTALL	DB68-11213A	1	
	HOLDER-REMOCON	DB61-06087A	1	
	SCREW-TAPPING(M4*L12)	6002-000213	2	
	CARD WARRNATY	6801-002246	1	
	SEAL-INSTALL OUTLET	B62-05580V	1	
	SEAL-PIPE SVC	DB62-05691C	1	
	CABLE TIE	DB65-10088C	8	





**Accessories (cont.)**

■ AC\*\*\*BNZDCH, AC\*\*\*KNZDCH

Item	Description	Code No.	Q'ty		Remark
			AC***BNZDCH	AC***KNZDCH	
	CARD WARRANTY	6801-002246	1	1	Indoor Unit
	MANUAL INSTALL	DB68-11271A	1	-	
		No code	-	1	

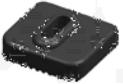
## Accessories (cont.)

■ AC\*\*\*BXADCH, AC\*\*\*BXSCCC, AC\*\*\*BXSCCH

Item	Description	Code No.	Q'ty					Remark
			AC009BXADCH AC012BXADCH	AC018BXADCH	AC024BXADCH AC030BXADCH AC036BXADCH AC042BXADCH AC048BXADCH	AC018BXSCCC AC024BXSCCC	AC030BXSCCC AC036BXSCCC AC030BXSCCH AC036BXSCCH	
	MANUAL INSTALL	DB68-11179A	1	-	-	-	-	Outdoor Unit
		DB68-11274A	-	1	1	1	1	
	RUBBER-LEG	DB67-01533A	4	-	-	-	-	
		DB73-00179A	-	4	-	4	-	
		DB73-20134A	-	-	4	-	4	
	SEAL DRAIN	DB63-10355C	-	4	3	-	-	
	DRAIN-PLUG OUT	DB67-20011A	1	-	-	-	-	
		DB67-00806A	-	1	1	-	-	

---

## 3. Disassembly and Reassembly

---

### ■ Necessary Tools

Item	Remarks
+SCREW DRIVER	
Adjustable Wrench (8mm, 10mm, 13mm)	
M6, M8 Hex Wrench	

### 3-1. Indoor unit

■ 1way CST : AC009BN1DCH, AC012BN1DCH

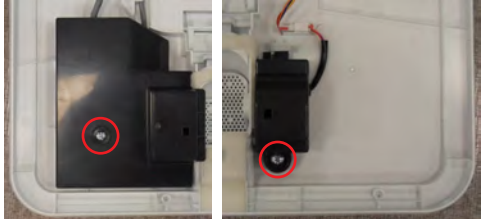

No	Parts	Procedure	Remark
1	PANEL AND FILTER WIND FREE TYPE (PC1NWFMMUN)	<ol style="list-style-type: none"> <li>1) Open the GRILLE as shown in the figure. - 3point</li> <li>2) Remove the FILTER from the PANEL.</li> <li>3) Remove the 3 COVER SCREW as shown in the figure.</li> <li>4) Remove the 6 screws fixed in PANEL and then remove the PANEL. (Use +Screw Driver)</li> <li>5) Press the left and right PANEL HOOK and then separate the PANEL from the indoor unit.</li> </ol>	



No	Parts	Procedure	Remark
1	<p>PANEL AND FILTER (Continues)</p>	<p>6) Open the GRILLE and then separate the CLIP WIRE.</p> <p>7) Remove the screws fixed in COVER DISPLAY, COVER MOTOR RIGHT and then remove the COVER DISPLAY, COVER MOTOR RIGHT. (Use +Screw Driver)</p> <p>8) Disconnect the connector. (Remote control receiver PBA and Display PBA)</p>	   



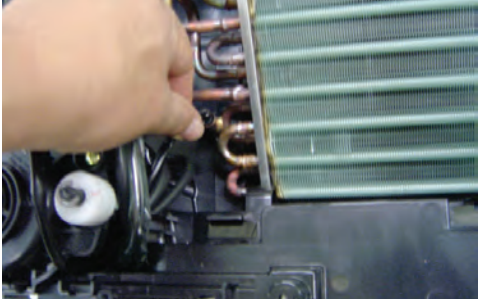

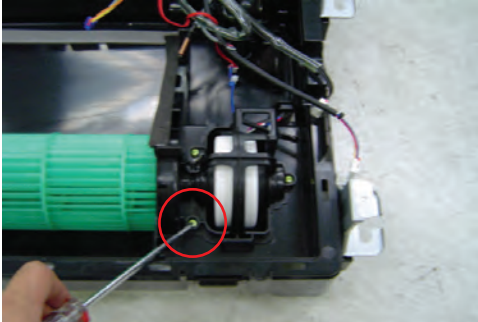
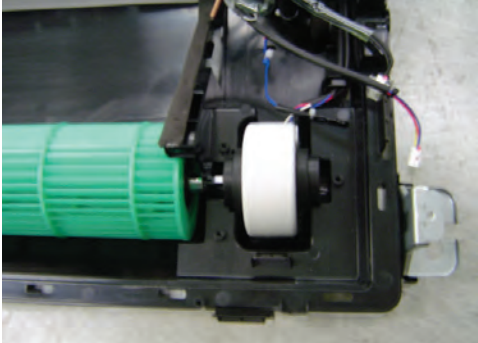

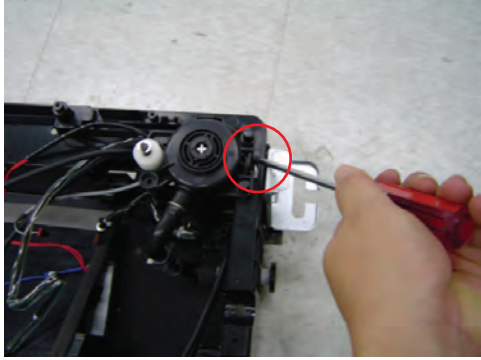

No	Parts	Procedure	Remark
1	<p>PANEL AND FILTER (Continues)</p>	<p>9) Remove the 4 screws fixed in STEP MOTOR and then remove the MOTOR. (Use +Screw Driver)</p> <p>10) Remove the 4 HINGE and then separate the BLADE H.</p> <p>11) Separate the SENSOR HUMIDITY.</p> <p>12) Remove the 4 screws fixed in GUIDE AIR and then remove the GUIDE AIR. (Use +Screw Driver)</p> <p>13) Separate the PLATE.</p>	





No	Parts	Procedure	Remark
		<p>2) Separate 8 connectors on the PCB of the Indoor Unit.</p> <p>3) Separate the Control In from the Indoor Unit.</p>	
2	Drain Sub	1) Push the hook on the Drain Sub to separate it.	





No	Parts	Procedure	Remark
3	Heat Exchanger	<p>1) Undo fixing screw in the Heat Exchanger. (Use +Screw Driver)</p> <p>2) Separate an Indoor Sensor from the Heat Exchanger.</p> <p>3) Separate the Heat Exchanger from the Indoor Unit.</p>	  
4	Cross Fan	<p>1) Undo 3 fixing screws on the Cover Fan Motor. (Use +Screw Driver)</p> <p>2) Separate the Cover Fan Motor from the Indoor Unit.</p>	 

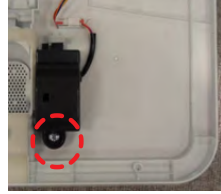



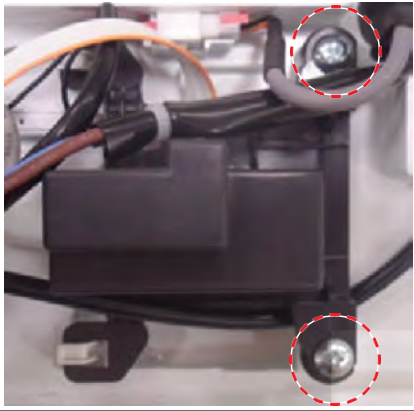

No	Parts	Procedure	Remark
4		3) Separate the Cross Fan from the Indoor Unit.	
5	Drain Pump	<p>1) Separate fixing screw in the Cover Drain Pump. (Use +Screw Driver)</p> <p>2) Separate the Drain Hose from the Drain Pump.</p> <p>3) Separate the Drain Pump from the Indoor Unit.</p>	  

■ 1way CST : AC018BN1DCH

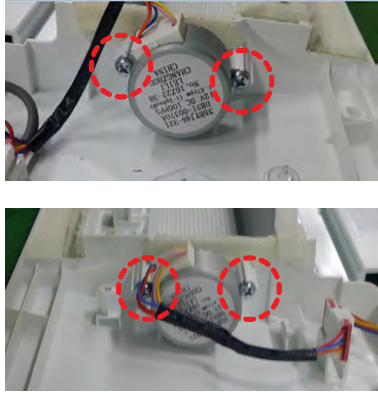
No	Parts	Procedure	Remark
1	<p>PANEL And FILTER WIND FREE TYPE (PC1BWFM*N)</p> <p>Air Purification PANEL (PC1NBFMUN) (Continues)</p>	<p>1) Open the GRILLE as shown in the figure. - 4point</p> <p>2) Remove the FILTER from the PANEL.</p> <p>3) Remove the 3 COVER SCREW as shown in the figure.</p> <p>4) Remove the 7 screws fixed in PANEL and then remove the PANEL. (Use +Screw Driver)</p> <p>5) Press the left and right PANEL HOOK and then separate the PANEL from the indoor unit.</p>	      

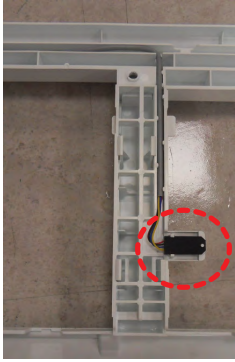

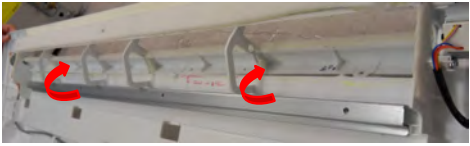

No	Parts	Procedure	Remark
1	<p>PANEL And FILTER (Continues)</p>	<p>6) Open the GRILLE and then separate the CLIP WIRE.</p> <p>7) Remove the screws fixed in COVER DISPLAY, COVER MOTOR RIGHT and then remove the COVER DISPLAY, COVER MOTOR RIGHT . (Use +Screw Driver)</p> <p>8) Disconnect the connector. (Remote control receiver PBA and Display PBA)</p>	    

No	Parts	Procedure	Remark
1	Air Purification Panel only (PC1BWC**N) (Continues)	9) Please separate the air purificaion CONTROL BOX COVER.             10) Remove the dust sensor fixing SCREW             11) Please separate the HVPS fixed SCREW.	   

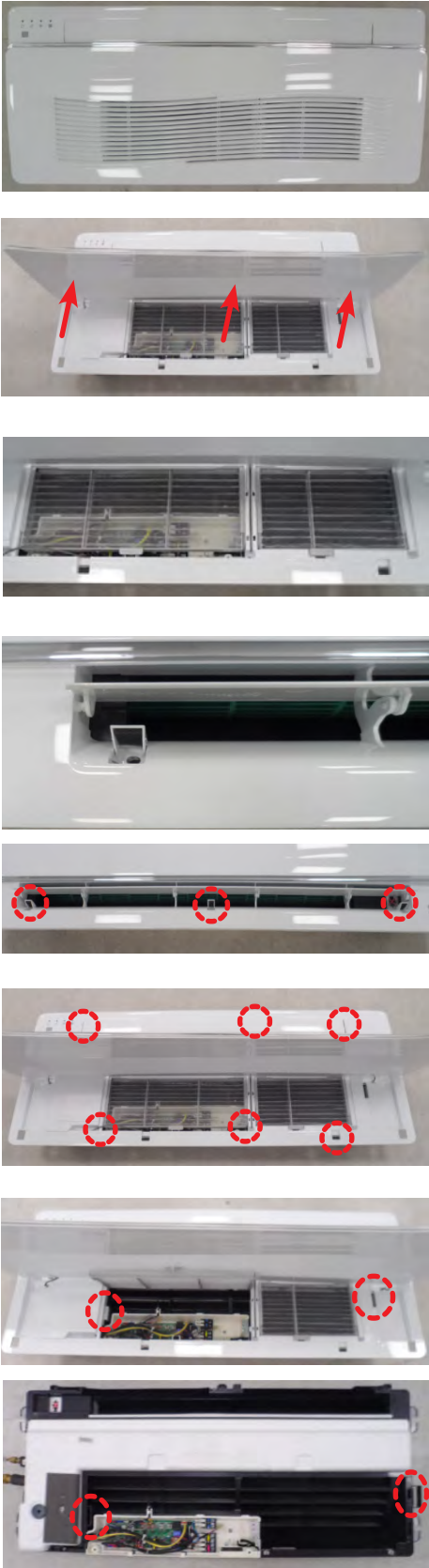
No	Parts	Procedure	Remark
1	PANEL And FILTER	<p>12) Remove the 4 screws fixed in STEP MOTOR and then remove the MOTOR. (Use +Screw Driver)</p> <p>13) Remove the 4 HINGE and then separate the BLADE H.</p> <p>14) Separate the SENSOR HUMIDITY.</p> <p>15) Remove the 5 screws fixed in GUIDE AIR and then remove the GUIDE AIR. (Use +Screw Driver)</p> <p>16) Separate the PLATE.</p>	     



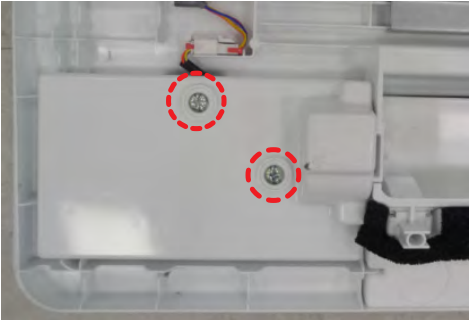



No	Parts	Procedure	Remark
1	<p>PANEL &amp; FILTER</p> <p>INTERIOR TYPE (PC1NWSMAN PC1BWSMAN)</p> <p>(Continues)</p>	<p>1) Open the GRILLE, as shown in the picture.</p> <p>2) Separate the FILTER from the PANEL.</p> <p>3) Remove the 2 COVER SCREW.</p> <p>4) Remove the 5 screws fixed in PANEL and then separate from the indoor unit. (Use +Screw Driver)</p> <p>5) Press the left and right side HOOK of PANEL and then separate the PANEL from the indoor unit.</p>	



No	Parts	Procedure	Remark
1	<p>PANEL &amp; FILTER (cont.) (Continues)</p>	<p>6) Open the GRILLE and then raise the LINK LEVER SWITCH (yellowish green) of left and right in the direction of arrow and then separate the LINK LEVER.</p> <p>7) Remove the fixing screws from the COVER DISPLAY using electric motion driver and separate it.</p> <p>8) Disconnect the connectors of remote control receiver PBA / display PBA.</p>	    



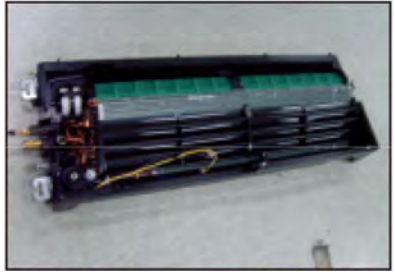

No	Parts	Procedure	Remark
1	PANEL & FILTER	<p>1) Press the PUSH BUTTON and open the GRILL.</p> <p>2) First, remove the clip from the PANEL. And then incline the GRILLE by 90° and separate the GRILLE from the PANEL.</p> <p>3) Separate the FILTER from the PANEL.</p> <p>4) Remove the 4 COVER SCREW.</p> <p>5) Remove the 7 screws fixed in PANEL and then separate from the indoor unit. (Use +Screw Driver)</p>	

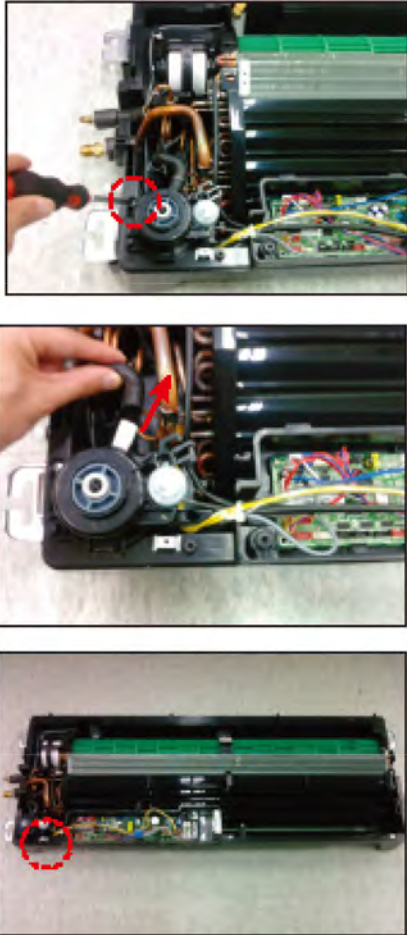

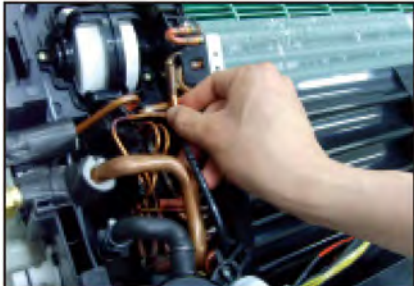
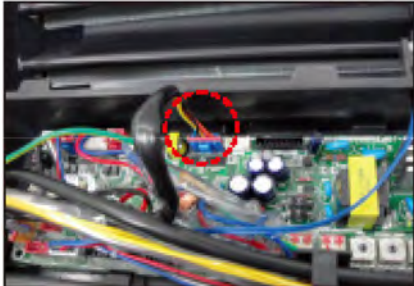

No	Parts	Procedure	Remark
2	DRAIN PAN	<p>1) Press the left and right side HOOK of PANEL and then separate the PANEL from the indoor unit.</p> <p>2) Remove the 6 screws fixed in DRAIN PAN. (Use +Screw Driver)</p> <p>3) Remove the 2 HOOK fixed in DRAIN PAN and then separate from the indoor unit.</p> <p><b>⚠ When disassembling the PAN, be careful not to touch the heat exchanger board with a bare hand.</b></p>	

No	Parts	Procedure	Remark
4	Electrical equipment parts (Continues)	<p>1) Remove the 3 screws fixed in electrical equipment parts and then separate the COVER. (Use +Screw Driver)</p> <p>2) Separate the 8 connectors from the indoor unit PCB, as shown in the picture.</p> <p><b>▲ Turn off the power necessarily in case of contact pan area. Be careful, it may cause injury on the sharp sides of the pan.</b></p> <p>3) Separate the electrical equipment parts from the indoor unit.</p>	    





No	Parts	Procedure	Remark
5	DRAIN PUMP	<p>1) Remove the 3 screws fixed in COVER DRAIN PUMP. (Use +Screw Driver)</p> <p>2) First, loosen the BAND RING. And then separate the DRAIN HOSE from the DRAIN PUMP.</p> <p>3) Separate the DRAIN PUMP from the indoor unit.</p>	
6	DRAIN SUB	<p>1) Remove the screw fixed in DRAIN SUB. (Use +Screw Driver)</p> <p>2) Hold the HOOK of DRAIN SUB and separate it.</p>	

No	Parts	Procedure	Remark
7	Heat Exchanger	<p>1) Remove the screw fixed in Heat Exchanger. (Use +Screw Driver)</p> <p>2) Separate the indoor unit SENSOR from the Heat Exchanger.</p> <p>3) Separate the EEV connector from the PCB.</p> <p>4) Separate the Heat Exchanger from the indoor unit.</p> <p>5) Separate the EXPANSION COIL from the EEV BODY. (When servicing the EEV)</p>	    



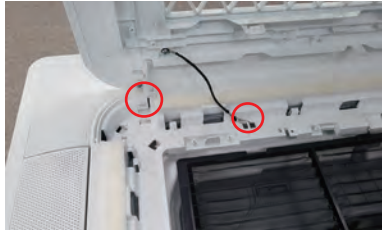

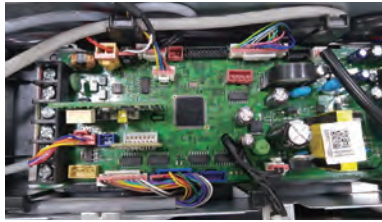

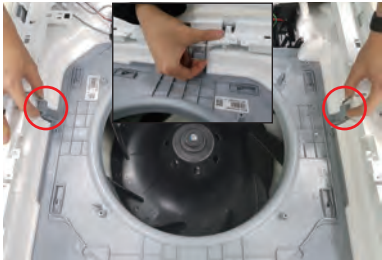
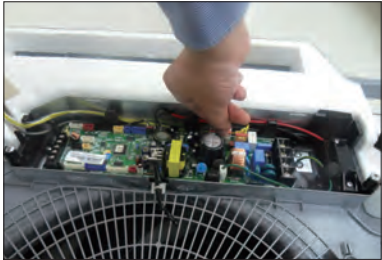
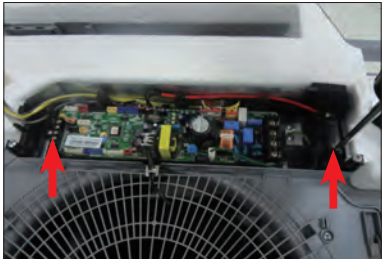
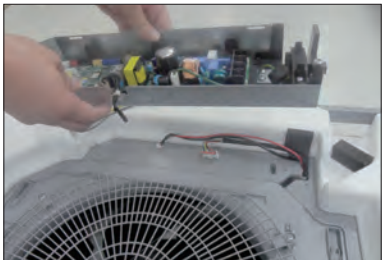

No	Parts	Procedure	Remark
8	DRAIN PUMP	<p>1) Remove the 3 screws fixed in COVER FAN MOTOR. (Use +Screw Driver)</p> <p>2) Remove the screw fixed in HOLDER FAN. (Use +Screw Driver)</p> <p>▲ If the reassembly, end surface of HOLDER FAN and surface of ASSY CROSS FAN_L should be consistent.</p> <p>3) Separate the COVER FAN MOTOR from the indoor unit.</p> <p>4) Remove the screw fixed in CROSS FAN. (Use +Screw Driver)</p> <p>5) Separate the CROSS FAN from the indoor unit.</p>	    

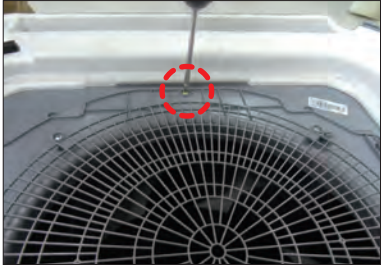

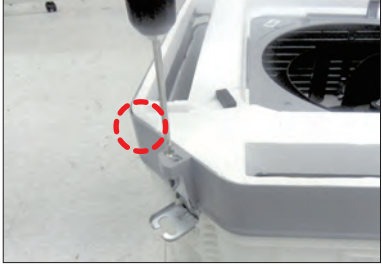

■ 4way CST : AC\*\*\*BN4DCH

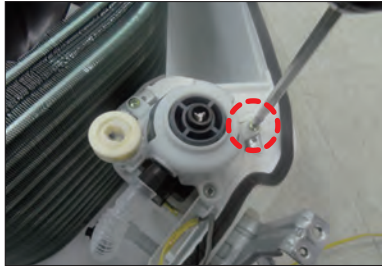
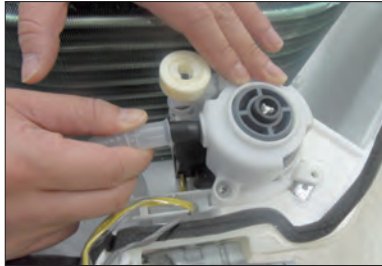
No	Parts	Procedure	Remark
1	Panel	<p>1) Pull two levers below Samsung logo to open the grille.</p> <p>2) Detach the safety clip and white link from the panel.</p> <p>3) Remove the 2 fixed screws to remove the Control-Box Cover. (Use +Screw Driver)</p> <p>4) Remove the 4 connector wires from the PBA. (Remocon-Receiver, Blade motor and Humidity sensor)</p> <p>5) Detach the 4 corners of the panel using both hands..</p>	    

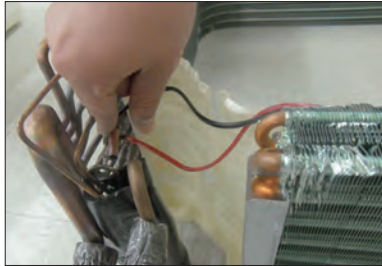
No	Parts	Procedure	Remark
1	Panel	<p>6) Disassemble the bolts that are assembled with the indoor unit at the 4 panel corners.</p> <p>7) Press the Steel Hangers at both sides of the panel inwards, and rotate them 90 degrees to remove it from the indoor unit's Hock. Remove the panel from the indoor unit.</p>	 
2	Control-Box	<p>1) Disconnect the Connector Wire that is connected to the indoor unit's PBA from the PBA.</p> <p>2) Unscrew the 2 fixed screws on both sides of the Control Box, and disassemble the Control Box from the indoor unit. (Use +Screw Driver)</p>	  

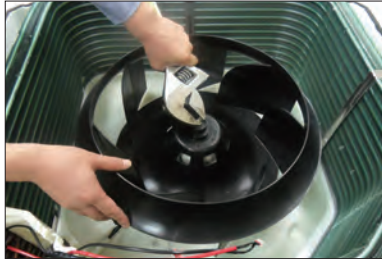
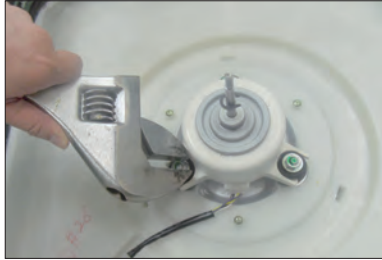
No	Parts	Procedure	Remark
3	Bell-Mouth	<p>1) Unscrew the screw fixed on the Bell-Mouth. (Use +Screw Driver)</p> <p>2) Push the Bell-Mouth in the direction opposite to where it's installed on the Control-Box to remove it.</p>	 
4	Drain Pan	<p>1) Unscrew the screws on the 4 corners of the indoor unit. (Use +Screw Driver)</p> <p>2) Remove the Drain Pan from the indoor unit.</p>	 

No	Parts	Procedure	Remark
5	Drain Pump & Hose	<p>1) Remove the 2 fixed screws and disconnect the white drainage hose from the Drain Pump. (Use +Screw Driver)</p> <p>2) Remove the 2 screws and take the Drain-Hose out from the indoor unit to disassemble the transparent Drain-Hose fixed on the side of the indoor unit. (Use +Screw Driver)</p>	  
6	Evap. Temperature Sensor	<p>1) Use your hand to remove the temperature sensor attached to the Evap Pipe along with the fixing clip.</p>	



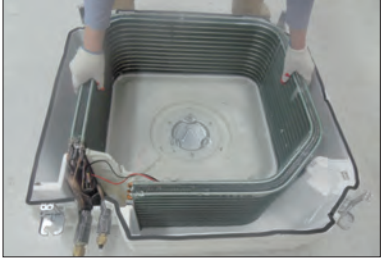
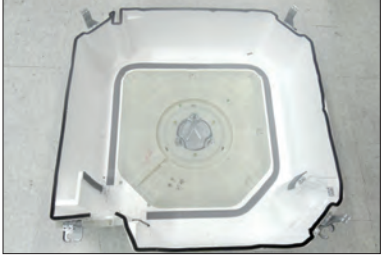

No	Parts	Procedure	Remark
7	Fan & Motor	<p>1) Turn the hexangular nut attached to the top of the Fan counterclockwise to remove it. Take the Fan out of the Motor.</p> <p>2) Turn the three hexangular nuts on the Motor counterclockwise to remove the nuts. Take the Motor Wires attached to these three locations out with your hands prior to removing the Motor.</p>	  
8	Evaporator (Continues)	<p>1) Remove the screws of the 2 Steel Holder Evaps that are used to fix the Heat Exchanger, and then remove it. (Use +Screw Driver)</p> <p>2) Remove the 2 fixing screws of the Partition Evap at the Heat Exchanger's In/Out Pipe. (Use +Screw Driver)</p>	 

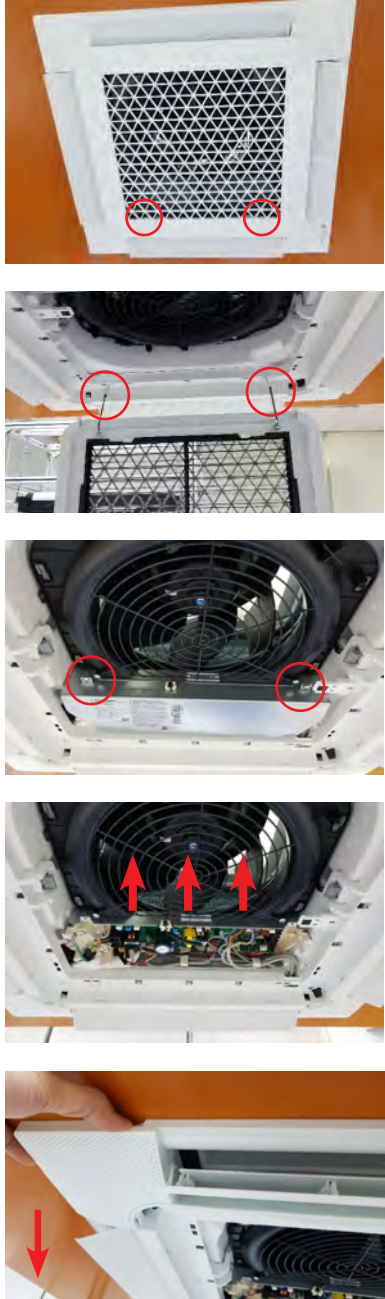

No	Parts	Procedure	Remark
9	Evaporator	<p>3) Remove the screw of the Cover Pipe that is used to fix the In/Out Pipe. Remove the In/Out Pipe. (Use +Screw Driver)</p> <p>4) Remove the Heat Exchanger from the indoor unit's cabinet.</p>	  

■ 4way CST(600x600) : AC\*\*\*BNNDCH

No	Parts	Procedure	Remark
1	Panel	<p>1) Pull both hooks and take the grille downward. Two safety clips are mounted to the front grille to prevent it from dropping.</p> <p>2) Detach the safety clip and take up the grille.</p> <p>3) Remove the 2 fixed screws to remove the Control-Box Cover. (Use +Screw Driver)</p> <p>4) Remove the remote control-receiver, blade conector and humidity sensor wires from the PBA. (4EA)</p> <p>5) Push the 4 panel corners and cover downwards to remove it.</p>	

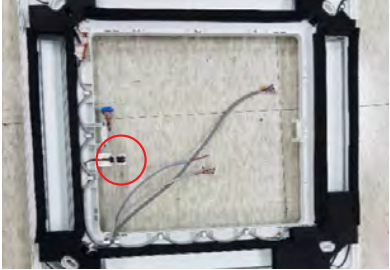
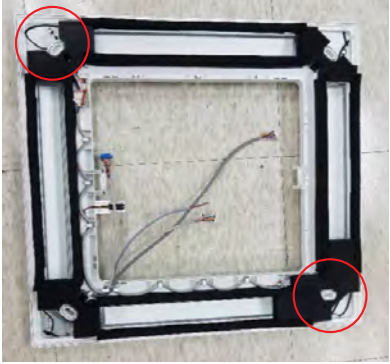

No	Parts	Procedure	Remark
		<p>6) Disassemble the bolts that are assembled with the indoor unit at the 4 panel corners.</p>	
		<p>7) Press the Hangers at both sides of the panel inwards, to remove it from the indoor unit's hook. Remove the panel from the indoor unit.</p>	
2	Blade	<p>1) Remove the hinge-blade and blade.</p>	
3	Display PBA	<p>1) Remove the cover display.</p> <p>2) Remove the cover PBA from the cover display.</p>	

No	Parts	Procedure	Remark
		3) Disconnect the connector wire from the PBA.	
4	Humidity Sensor	1) Remove the humidity sensor from the panel.	
5	Step motor	<p>1) Unscrew 2 screws on cover motor. (Use +Screw Driver)</p> <p>2) Remove 2 cover motor.</p> <p>3) Remove the 2 fixed screws and disassemble the step motor. (Use +Screw Driver)</p>	 

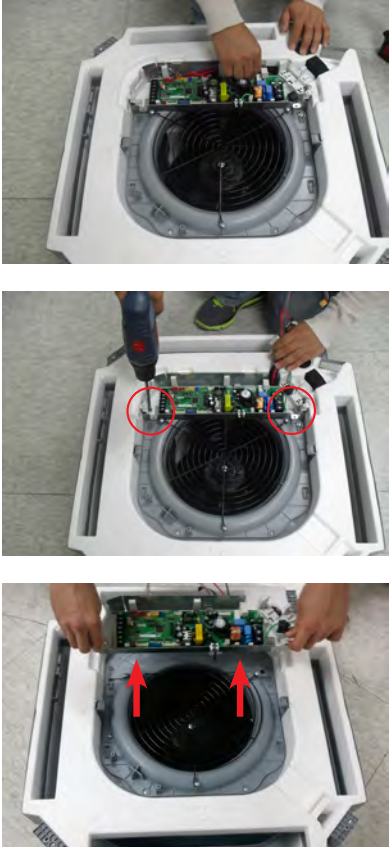
No	Parts	Procedure	Remark
6	Control-Box	<p>1) Disconnect the Connector Wire that is connected to the indoor unit's PBA.</p> <p>2) Unscrew the 2 fixed screws on both sides of the Control Box, and disassemble the Control Box from the indoor unit. (Use +Screw Driver)</p>	

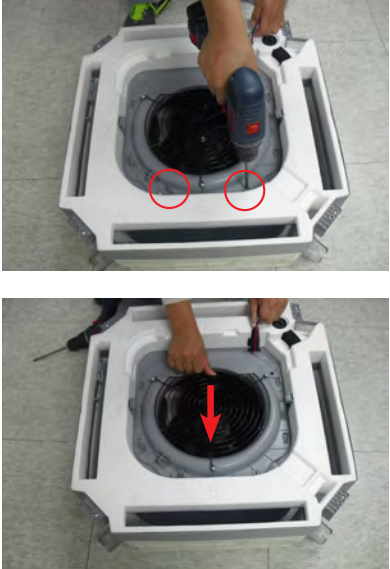
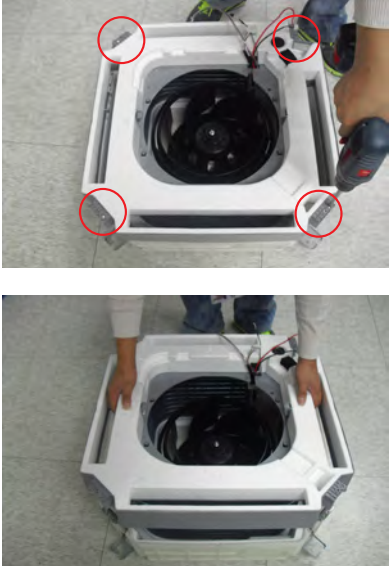
No	Parts	Procedure	Remark
7	Bell-Mouth	<p>1) Unscrew the screw fixed on the Bell-Mouth. (Use +Screw Driver)</p> <p>2) Push the Bell-Mouth in the direction opposite to where it's installed on the Control-Box to remove it.</p>	
8	Drain Pan	<p>1) Unscrew the screws on the 4 corners of the indoor unit. (Use +Screw Driver)</p> <p>2) Remove the Drain Pan from the indoor unit.</p>	

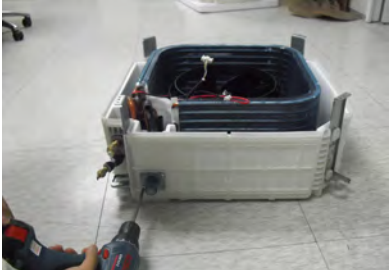
No	Parts	Procedure	Remark
9	Drain Pump & Hose	<p>1) Remove the 2 fixed screws and disconnect the white drainage hose from the Drain Pump. (Use +Screw Driver)</p> <p>2) Remove the 2 screws and take the Drain-Hose out from the indoor unit to disassemble the transparent Drain-Hose fixed on the side of the indoor unit. (Use +Screw Driver)</p>	  
10	Evap. Temperature Sensor	<p>1) Use your hand to remove the temperature sensor attached to the Evap Pipe along with the fixing clip.</p>	

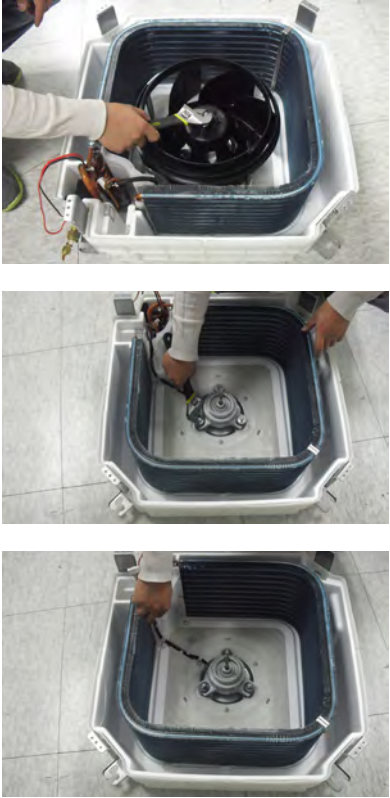
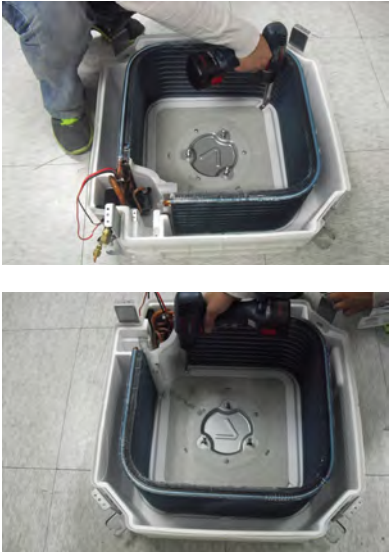
No	Parts	Procedure	Remark
11	Fan & Motor	<p>1) Turn the hexagonal nut attached to the top of the Fan counterclockwise to remove it. Take the Fan out of the Motor.</p> <p>2) Turn the three hexagonal nuts on the Motor counterclockwise to remove the nuts. Take the Motor Wires attached to these three locations out with your hands prior to removing the Motor.</p>	
12	Evaporator	<p>1) Remove the screws of the Steel Holder Evaps that are used to fix the Heat Exchanger, and then remove it. (Use +Screw Driver)</p> <p>2) Remove the 2 fixing screws of the Partition Evap at the Heat Exchanger's In/Out Pipe. (Use +Screw Driver)</p>	

No	Parts	Procedure	Remark
		<p>3) Remove the screw of the Cover Pipe that is used to fix the In/Out Pipe. Remove the In/Out Pipe. (Use +Screw Driver)</p> <p>4) Remove the Heat Exchanger from the indoor unit's cabinet.</p>	  

■ 360 CST : AC\*\*\*BN6DCH

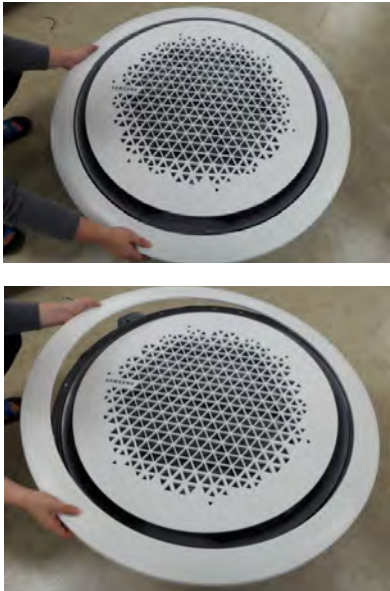
No.	Parts	Procedure	Remark
1	Panel	<p>▶ Ceiling type Panel</p> <p>1) Pull up the corner 4 places of Panel and separate it.</p> <p>2) Remove 4ea of screws from the corner of Panel. (Use +Screw Driver)</p> <p>3) Pull the hook of Panel and then separate the Panel from the Indoor Unit.</p>	
1	Panel	<p>▶ Open type Panel</p> <p>1) Rotate the outside Panel to counterclockwise direction and then separate it.</p>	



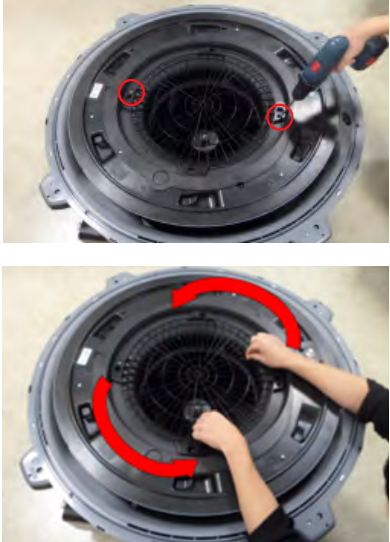

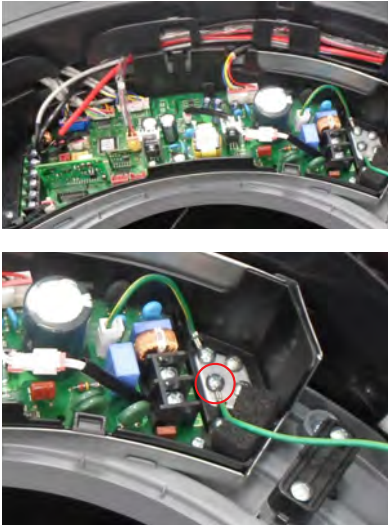
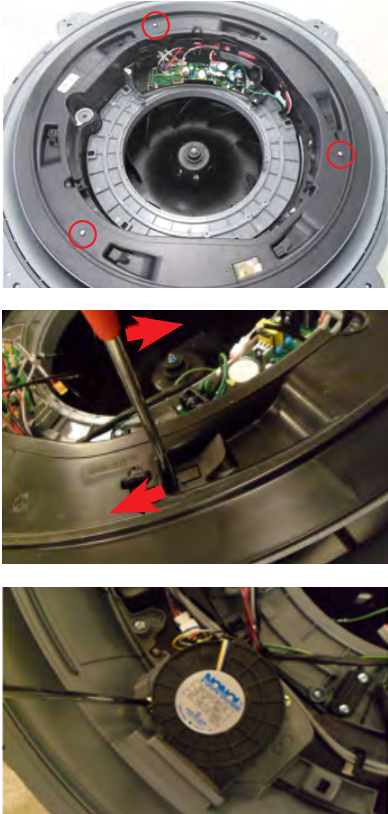

No.	Parts	Procedure	Remark
1	Panel	<p>2) Rotate the Grille to counterclockwise direction.</p> <p>3) Remove the safety clip of Grill inside and then separate the Panel from the Indoor Unit.</p> <p>4) Pull up the Filter from the Grill and separate it.</p>	
2	Control Box	<p>1) Remove 2ea of screws which is fixed to the Indoor Unit upper part. (Use +Screw Driver)</p> <p>2) Rotate the Guard Fan to counterclockwise direction and separate it</p>	

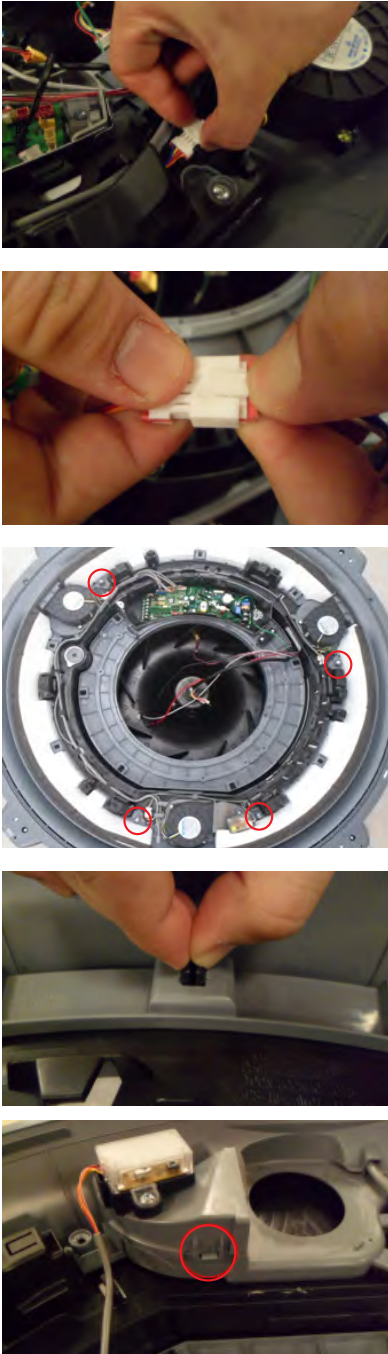



No.	Parts	Procedure	Remark
2	Control Box	<p>3) Remove a screw which is fixed to the Indoor Unit upper part. (Use +Screw Driver)</p> <p>4) Put finger in the "PULL" marked groove and then pull up the Cover</p> <p>5) Put finger in the "PULL" marked groove and then avoids the hook and it opens the Control Box Cover</p>	

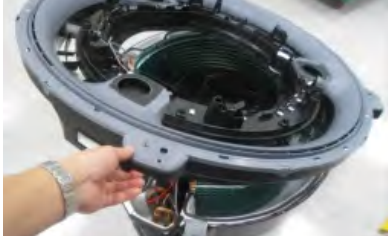

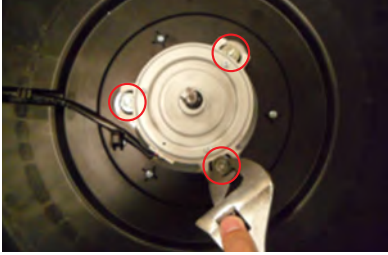

No.	Parts	Procedure	Remark
2	Control Box	<p>6) Separate the connectors from the Control Box.</p> <p>7) Remove the ground screw. (Use +Screw Driver)</p>	
3	Top Cover & Drain Pan	<p>1) Remove the 3ea of screws. (Use +Screw Driver)</p> <p>2) Push the hook and separate the Cover.</p> <p>⚠ Damage can occur to product in case of use a sharp tool.</p> <p>3) Remove the screw which is fixed to Booster Fan. (Use +Screw Driver)</p>	

No.	Parts	Procedure	Remark
3	Top Cover & Drain Pan	<p>4) Pull the Booster Fan connector and separate the connector.</p> <p>5) Remove the 4ea of screws (Use +Screw Driver)</p> <p>6) Push the hook and separate the Cover.</p>	

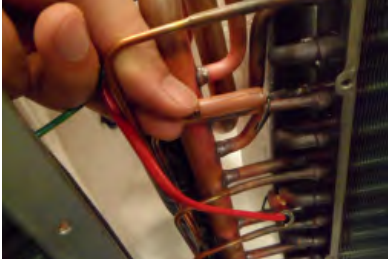
No.	Parts	Procedure	Remark
3	Top Cover & Drain Pan	<p>7) Remove the screw and separate the Display Cover. (Use +Screw Driver)</p> <p>8) Remove the 2ea of screws. (Use +Screw Driver)</p> <p>9) Push the hook and separate the Cover.</p> <p>10) Remove 8ea of screws. (Use +Screw Driver)</p> <p>11) Separate the Indoor Unit upper part from the Body.</p>	    

No.	Parts	Procedure	Remark
3	Top Cover & Drain Pan	<p>12) Remove the 3ea of screws. (Use +Screw Driver)</p> <p>13) Pull the hook that is on the side and separate the Cover.</p>	
4	Drain Pump & Hose	1) Separate the Drain Hose from the Drain Pump.	



No.	Parts	Procedure	Remark
4	Drain Pump & Hose	2) Remove 2ea of screws and separate the Drain Hose that is on the side lower part of Indoor Unit. (Use +Screw Driver)	
5	Fan & Motor	1) Remove the hex nut which is fixed to top of Fan and separate the Fan from the Motor. (Use Monkey Spanner)  2) Remove the 3 hex nuts which is fixed to Motor and separate the Motor from the Indoor Unit. (Use Monkey Spanner)	 
6	Temperature Sensor	1) Remove 6ea of screws which are fixed to Evaporator and separate the Partition.  2) Separates the Temperature Sensor which is fixed to Evaporator Pipe with the fixing clip together by the hand.	 



No.	Parts	Procedure	Remark
7	Evaporator	<p>1) Remove 2ea of screws which are fixed to Indoor Unit and separate the Evaporator fixing bracket. (Use +Screw Driver)</p> <p>2) Remove a screw which is fixed to Indoor Unit and pull the hook and then separate the Drain Cover. (Use +Screw Driver)</p> <p>⚠ When assemble, be careful with the interference structure of piping projecting p</p> <p>3) Separate the Evaporator from the Indoor Unit.</p> <p>⚠ If you remove the Evaporator with bare hands, it may injure your hands, gloves must be worn.</p>	    



■ Home duct : AC\*\*\*BNLDCH

No	Parts	Procedure	Remark
1	Motor & Blower (Continues)	<p>1) Disassemble the Cabinet Top Motor. - Unscrew 6 screws</p> <p>2) Disassemble the Cover Blower Upper with pushing its hook.</p> <p>3) Disassemble the Cover Control. - Unscrew 2 screws</p> <p>4) Disassemble Motor Wires connected to the inside of PCB.</p> <p>5) Disassemble the band Motor for fixing the Motor. - Unscrew 2 screws</p>	    



No	Parts	Procedure	Remark
1	Motor & Blower	6) After disassembling the Motor and Blower for the set, disassemble the Blower by use of 3mm wrench.	
2	Drain Pan	<p>1) Disassemble the Cabinet Top Evap. - Unscrew 4 screws.</p> <p>2) Disassemble the Drain Cushion from the set.</p>	 

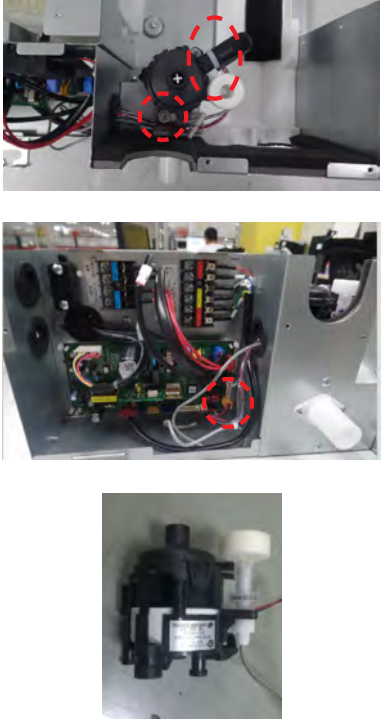

No	Parts	Procedure	Remark
3	Evaporator	<p>1) Disassemble the Cover Pipe that fixes the high/low pressure Pipe.                      - Unscrew 2 screws</p> <p>2) Disassemble the Support Evap RH.                      - Unscrew 4 screws</p> <p>3) Disassemble the refrigerant temperature sensor, Inlet air temperature sensor, and EEV wire that connected to the inside of PCB.</p> <p>4) Disassemble the Evaporator form the set.</p>	  





No	Parts	Procedure	Remark
5	Drain Pump &Flow-switch	<p>1) Disassemble the Drain Pump.                      - Unscrew 2 screws                      - Cut 2 tie</p> <p>2) Disassemble the Drain Pump and Flow-switch wire that connected to the inside of PCB.</p> <p>3) Disassemble Drain Pump &amp;Flow-switch from the set.</p>	

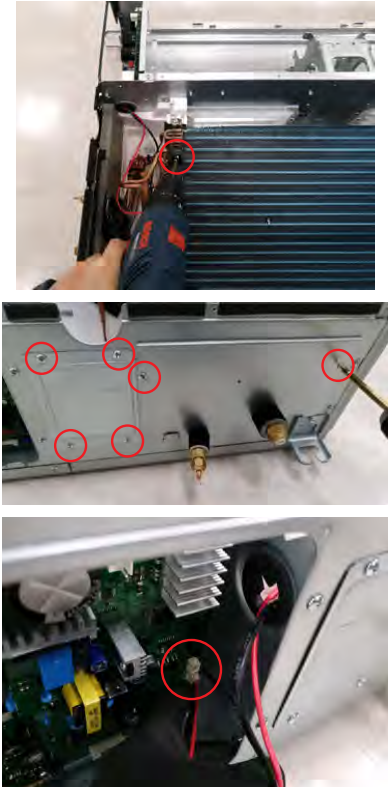

■ Duct S : AC009BNHDCH, AC012BNHDCH

No	Parts	Procedure	Remark
1	Motor & Blower	<p>1) Disassemble the Cabinet Bottom Fan. - Unscrew 10 screws</p> <p>2) Disassemble the 2 Case Blower Bottom. - Unscrew 4 screws</p> <p>3) Disassemble the Cover Control. - Unscrew 2 screws</p> <p>4) Disconnect the motor wire.</p> <p>5) Disassemble the 2 Holder Motor. - Unscrew 2 screws.</p>	    

No	Parts	Procedure	Remark
1	Motor & Blower	<p>6) After disassembling the Motor and Blower for the set, disassemble the Blower by use of 3mm wrench.</p> <p>7) Disassemble the both of Case Blower Out. - Unscrew 4 screws.</p>	
2	Drain Pan & Drain Pump	<p>1) Disassemble the Cabinet Bottom Evap. - Unscrew 7 screws.</p> <p>2) Pull the Drain Pan Out.</p> <p>3) Disassemble the drain Pump. - Unscrew 4 screws and disassemble 2 connectors.</p>	



No	Parts	Procedure	Remark
3	EVAP	<p>1) Disassemble the Support Evap. - Unscrew 1 screws.</p> <p>2) Disassemble the Cover Pipe. - Unscrew 2 screws.</p> <p>3) Disconnect the wire between assy control out and Evap.</p>	
3	EVAP	<p>4) Disassemble the Evap. - Unscrew 3 screws. Then pull the Evap out</p>	



No	Parts	Procedure	Remark
4	Cushion	1) Pull out the Cushion.  2) Disassemble the Seal Cushion LF. - Unscrew 1 screws  3) Disassemble the Assy Cushion Right. - Unscrew 1 screws	
5	Case Blower & Bracket Motor	1) Disassemble the both of Case Blower Out. - Unscrew 4 screws  2) Disassemble the Bracket Motor. - Unscrew 6 screws	
6	Control	1) Disassemble the Case Control. - Unscrew 2 screws	

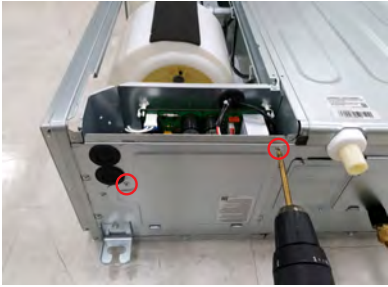

No	Parts	Procedure	Remark
7	Frame	1) Disassemble the Frame. - Unscrew 6 screws	

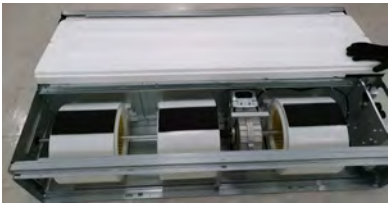
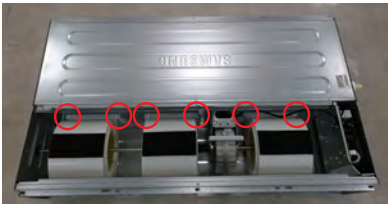
■ Duct S : AC018/024/030/036/042/048BNHDCH

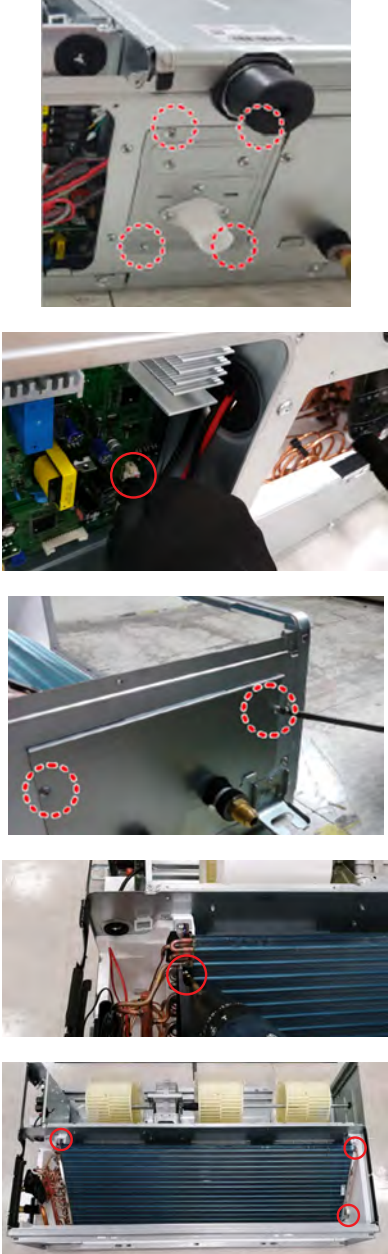
No	Parts	Procedure	Remark
1	Common	1) Disassemble the Cabinet Bottom Fan. - Unscrew 11 screws  2) Disassemble the Cover Control. - Unscrew 2 screws  3) Disassemble the Cabinet Bottom Evap. - Unscrew 8 screws	  
2	Drain & Evap	1) Disassemble the Drain Pan from the set.  2) Disassemble the 3 Case Blower Bottom. - Unscrew 6 screws.	 





No	Parts	Procedure	Remark
2	Drain & Evap	<p>3) Disassemble the drain Pump. - Unscrew 4 screws and disassemble 2 connectors.</p> <p>4) Disconnect the wire between assy control out and Evap.</p> <p>5) Disassemble the Cover Pipe. - Unscrew 2 screws.</p> <p>6) Disassemble the Support Evap. - Unscrew 1 screws.</p> <p>7) Disassemble the Evap. - Unscrew 3 screws</p>	

No	Parts	Procedure	Remark
3	Motor & Blower	<p>1) Disconnect the motor wire.</p> <p>2) Disassemble the 1 Bracket Motor and 2 Holder Motors. - Unscrew 2 screws.</p> <p>3) After disassembling the Motor and Blower for the set, disassemble the Blower by use of 3mm wrench.</p> <p>4) Disassemble the 3 Case Blower Top. - Unscrew 6 screws.</p> <p>5) Disassemble the Bracket Motor. - Unscrew 6 screws.</p> <p>6) Disassemble the 3 Case Blower Out. - Unscrew 6 screws.</p>	

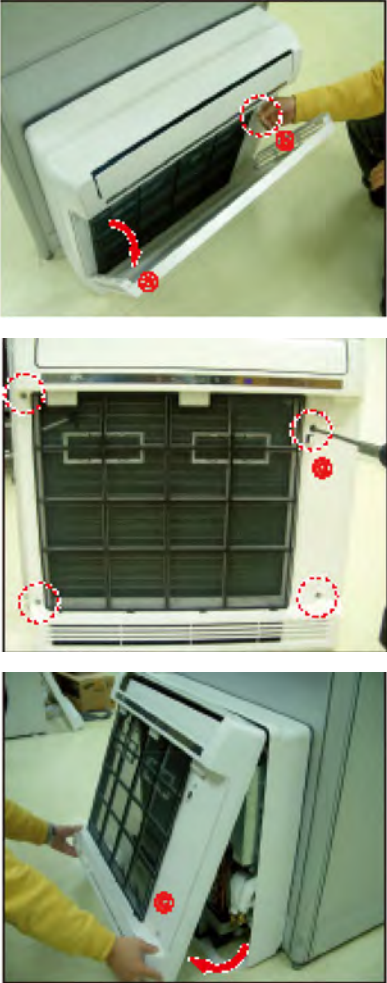
No	Parts	Procedure	Remark
4	Cushion	1) Pull out the Cushion  2) Disassemble the Assy Cushion Right. - Unscrew 1 screws  3) Disassemble the Seal Cushion LF. - Unscrew 1 screws	
5	Control	1) Disassemble the Case Control. - Unscrew 3screws	
6	Frame	1) Disassemble the Frame. - Unscrew 6 screws	

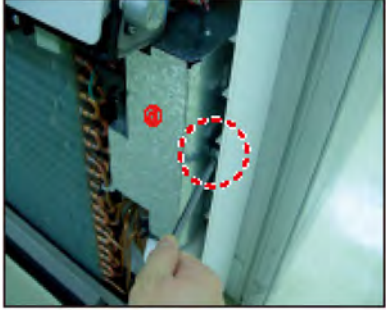

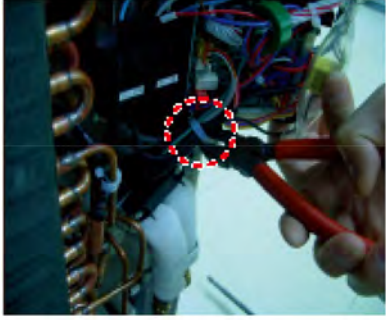
■ Console : AC\*\*\*BNJDCH

No	Parts	Procedure	Remark
1	Cabi Parts	<p>1) Open the Panel Front( a ). Remove the Clip Wire( b ).</p> <p>2) Release 4 screws on the Body Front( c ).</p> <p>3) Open the Body Front( c ) by pulling from bottom of the part.</p>	

No	Parts	Procedure	Remark
2	Electrical Parts (Continues)	<p>1) Open the cover of Control Box (d).</p> <p>2) Pull the PBA out along the slide guide.</p> <p>3) Cut the Cable tie.</p> <p>4) Pull all wires out from the PBA.</p>	   

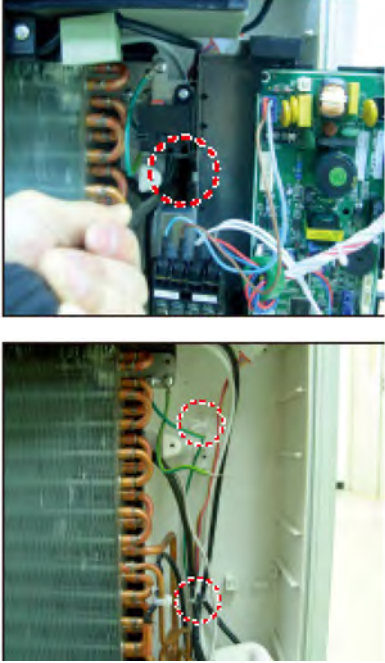
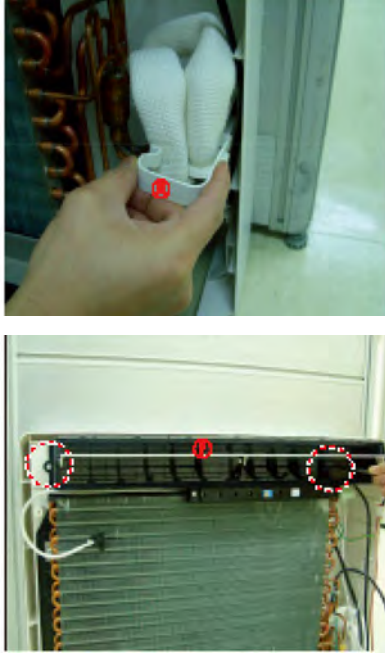

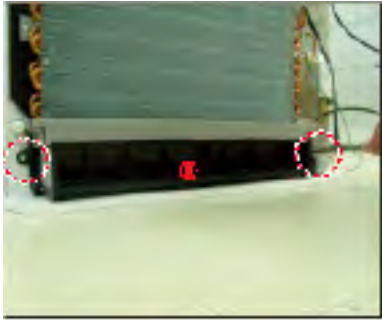
No	Parts	Procedure	Remark
2	Electrical Parts	<p>5) Release the 2 screws. (one is top of the C-Box, the other is left of it)</p> <p>6) Release 2 Hold Wires and pull all wires out from it .</p>	
3	Blowing & Evap Part (Continues)	<p>1) Pull the Bracket Pipe( e )out.</p> <p>2) Release 2 screws and pull Top Discharge Kit( f ) out.</p>	

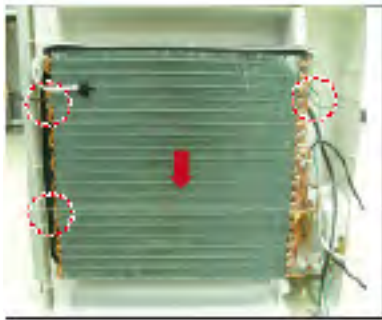
No	Parts	Procedure	Remark
3	Blowing & Evap Part	<p>3) Release 2 screws and pull Bottom Discharge Kit( ⑨ ) out.</p> <p>4) Disconnect the Step Motor wire( ㉞ ) from the conect wire . This part is right side of the Bottom Discharge Kit( ⑨ ).</p> <p>5) Pull Bottom Discharge Kit( ⑨ ) Out from the bottom of it.</p> <p>6) Release 3 screws and pull the Evap out from top to bottom direction.</p>	   

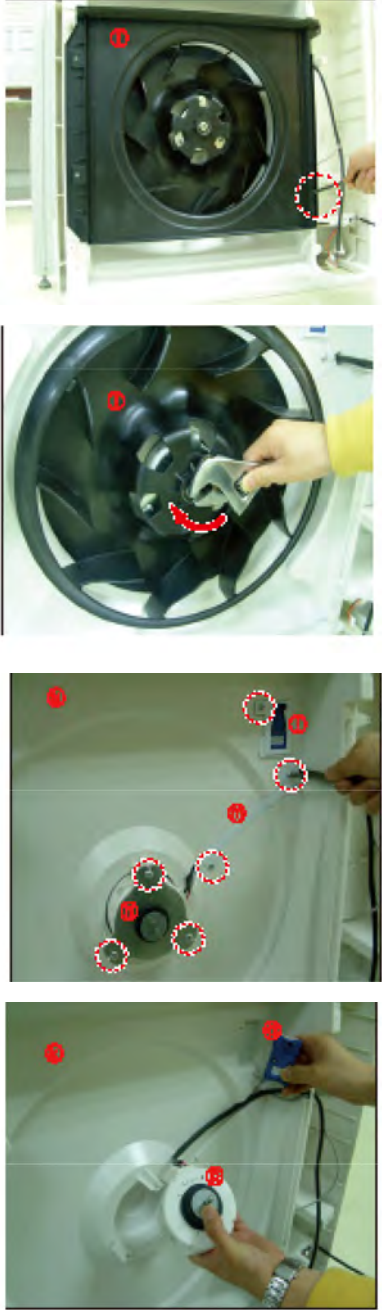
No	Parts	Procedure	Remark
4	Fan Part	<p>1) Release 1 screw and pull the Bell Mouth (i) out.</p> <p>2) Release the Nut and pull Fan Turbo (j) out.</p> <p>3) Release 6 screw on the Body Back (k). Pull the Cap MPI (l), Bracket Wire (m) and Bracket Motor (n) out.</p> <p>4) Pull the MPI Kit (o) and Motor</p>	

■ RAC(Windfree) : AC\*\*\*BNADCH

No	Parts	Procedure	Remark
1	PANEL-FRONT	<p>1) Stop the driving of air conditioner and shut off main power supply.</p> <p>2) Detach FILTER PRE from the PANEL FRONT.</p> <p>3) The COVER PANEL is fixed to body by hooks in center and side area.</p> <p>4) Separate the hook pulling end of the COVER PANEL as shown in figures. (Watch out for the damage of hooks)</p>	

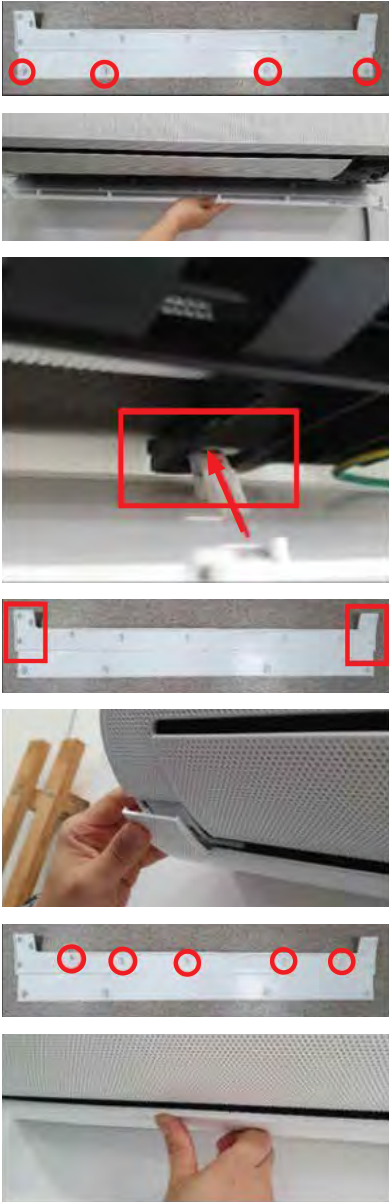
No	Parts	Procedure	Remark
1	PANEL-FRONT	<p>▲ Caution:                      Assembly of Cover Panel after service end.                      - Piping and Drain Hose must be careful not to damage and progress must be done with both hands.                      - Need to check all bottom hooks in holes of the main frame before you push to assemble.</p> <p>▲ Caution:                      - Assemble(push) side hooks.                      - Assemble(push) center 5 hooks each.</p>	

No	Parts	Procedure	Remark
1	PANEL-FRONT	<p>5) The GRILLE INLET is fixed to body by hooks in the center and side area.</p> <p>6) Separate the hook pulling end of the GRILLE INLET as shown in figures.(Watch out for the damage of hooks)</p> <p>7) To detach the PANEL FRONT from the main frame, unfasten 2 screws at the bottom. (use (+) Screw Driver)</p> <p>8) To detach the PANEL FRONT from the main frame, loosen 4 hook structures. When separate the hooks: pull out each ribs near the hooks as shown in figures. (Watch out for the damage of hooks)</p>	

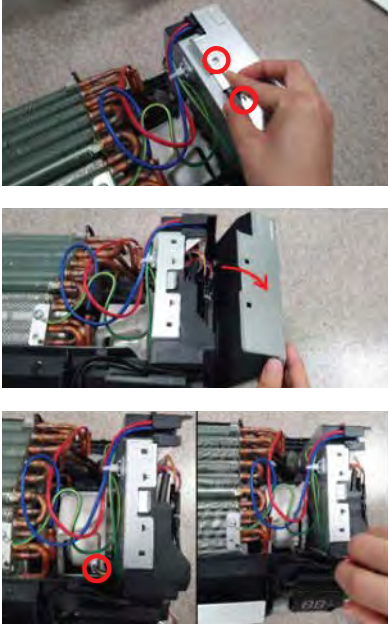
No	Parts	Procedure	Remark
1	PANEL-FRONT	9) Raise the PANEL FRONT upward as shown in the figure to separate the 3 hooks.	
2	CONTROL-IN	<p>1) To open the CONTROL-IN, raise the side flanges of the PLATE-RIGHT at an angle and unlock 2 hooks.</p> <p>2) To detach the CONTROLIN, unfasten a screw back of the PLATE-LEFT as shown in figures. (use (+) Screw Driver)</p>	

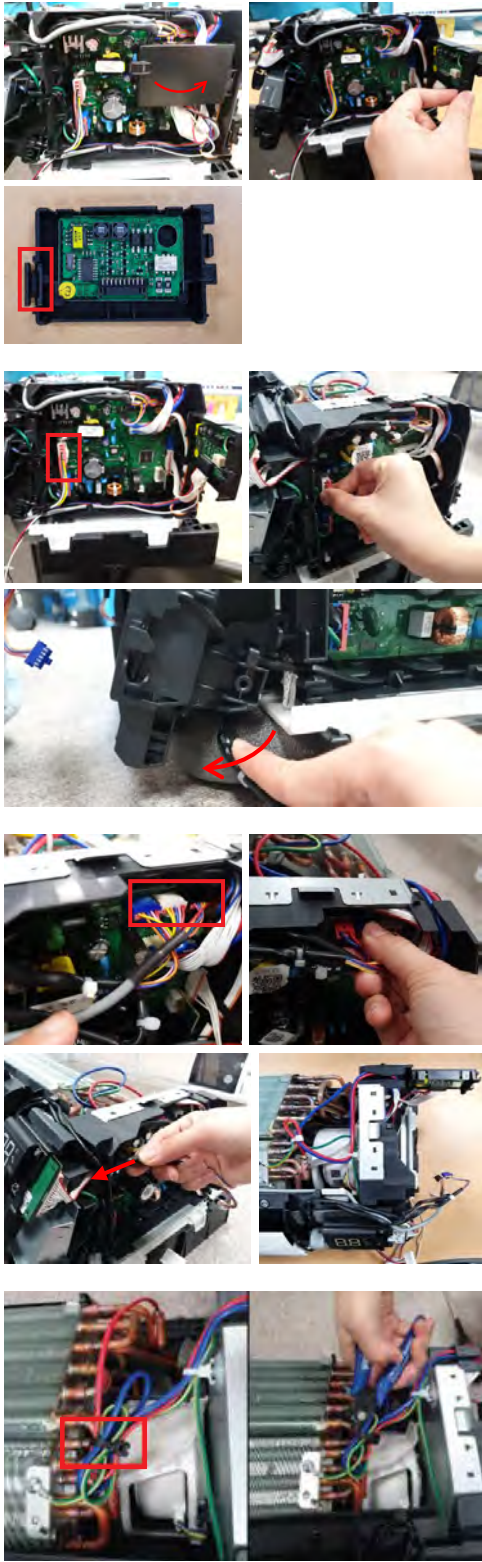
No	Parts	Procedure	Remark
2	CONTROL-IN	<p>3) Rotate CASE PCB 90 degrees as shown in figures. (Watch out for damage of hinge in CASE PCB)</p> <p>4) Separate Fan Moter wire as shown in figures.</p> <p><b>⚠ Caution:</b> When you separate the connector, pull pressing the locking button.</p> <p>5) Separate Blade Moter wire as shown in figures.</p> <p><b>⚠ Caution:</b> When you separate the connector, pull pressing the locking button.</p> <p>6) Cut off the Cable Tie tied up wires.</p>	

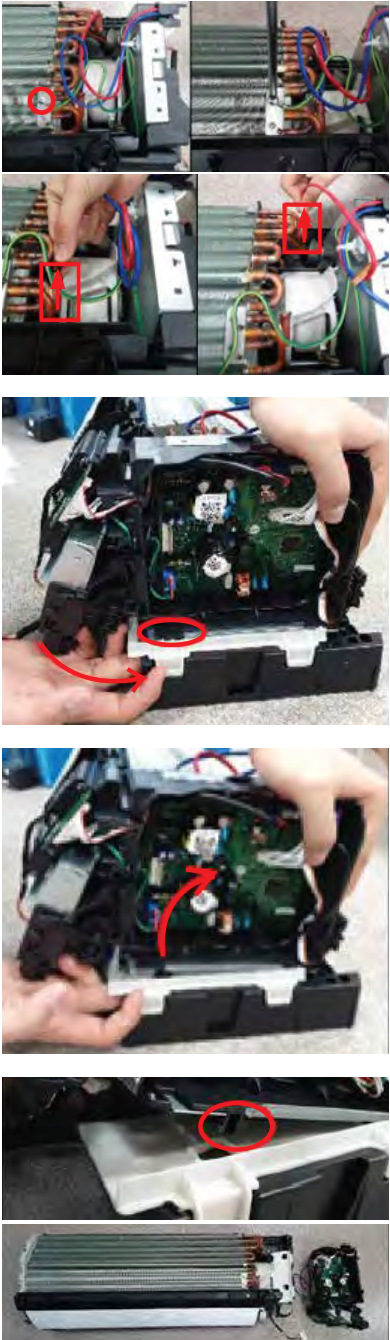

No	Parts	Procedure	Remark
2	CONTROL-IN	<p>7) Unfasten a screw of the Ground wire and pick up Temperature wires from ASSY EVAP. (Use (+) Screw Driver.)</p> <p>8) The CONTROL-IN is fixed to HOLER PIPE by a hook bottom of the case as shown in the last figure. (Please loosen remaining connectors before detaching CASECONTROL.</p> <p><b>▲ Caution:</b> When you separate the connector, pull pressing the locking button</p> <p>9) Put down of the HOLDER PIPE and push up the hook and lean side the case as shown in figures.</p>	

No	Parts	Procedure	Remark
3	TRAY DRAIN	<p>1) To detach the TRAY DRAIN from the main frame, pull the bottom of the TRAY DRAIN and it leans toward to you as shown in figures.</p> <p>2) Pull out the Drain Hose.</p>	

No	Parts	Procedure	Remark
4	EVAPORATOR	<p>1) The HOLDER PIPE is fixed to body by 2 hooks as shown in the figure.</p> <p>2) To detach the HOLDER PIPE from the main frame,loosen 2 hook structhres. When separate hooks: Use the (-) Screw Driver. Insert the (-) Screw Driver into the gap of the hook and lean to the Moter side as shown in figures. (Watch out for the damate of hooks)</p> <p>3) Remove the HOLDER PIPE.</p> <p>4) Unfasten a screw of the Fan Moter side. (Use (+) Screw Driver.)</p> <p>5) Unfasten 2 screws of the opposite side of the Fan Moter. (Use (+) Screw Driver.)</p>	

No	Parts	Procedure	Remark
4	EVAPORATOR	<p>6) Pull up the EVAPORATOR of the opposite side of the Fan Moter.</p> <p>7) loosen a hook of the Fan Moter side.</p> <p>8) Pull up the EVAPORATOR toward to you.</p>	

No	Parts	Procedure	Remark
5	FAN MOTOR & CROSS FAN	<p>1) Unfasten a screw on the COVER MOTER. (Use (+) Screw Driver.)</p> <p>2) Unwind the Moter Wire.</p> <p>3) Detach the COVER MOTER.</p> <p>4) Unfasten a screw of the CROSS FAN a little. (Use (+) Screw Driver.)</p> <p>5) Raise up the CROSS FAN of the left side and pull out from the Moter.</p>	

■ RAC(MAX) : AC\*\*\*BNTDCH

No	Parts	Procedure	Remark
1	Panel-Front	<p>1) Stop the driving of air conditioner and shut off main power supply.</p> <p>2) Open the FRONT-GRILLE and pull out from the PANEL-FRONT.</p> <p>3) Detach COVER-TERMINAL from the PANEL FRONT. (use + Screw Driver)</p> <p>4) Loosen connector wire(white) and detach the temperature sensor wire.</p> <p>5) To detach the FRONT-PANELthe main frame, unfasten 2 screw at the bottom. (use + Screw Driver )</p> <p>6) Take off the FRONT-PANEL,lifting up the bottom</p>	

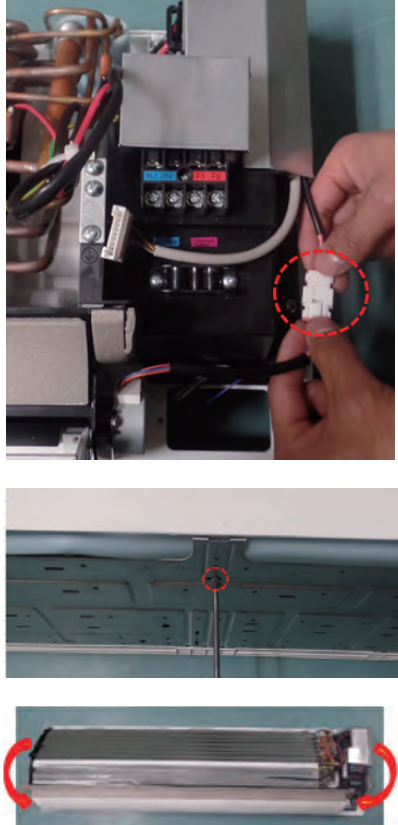
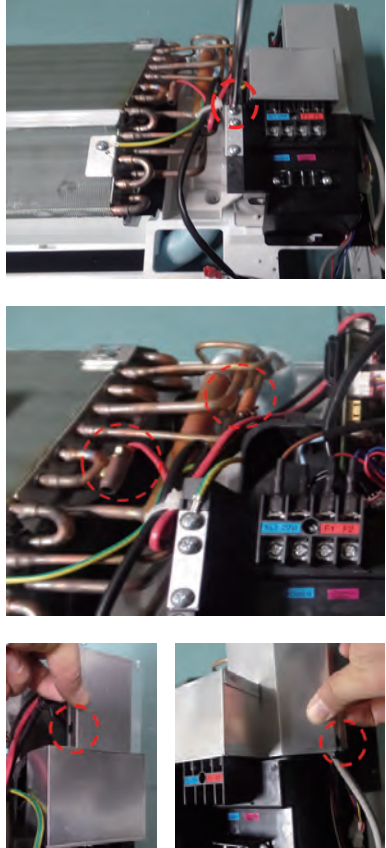
No	Parts	Procedure	Remark
2	TRAY DRAIN	<p>1) Loosen stepping motor wire and detach the hook of main frame.</p> <p>2) To detach TRAY-DRAIN from the main frame, pull the bottom of the TRAY-DRAIN towards you.</p> <p>3) To detach TRAY-DRAIN from the main frame, pull the bottom of the TRAY-DRAIN towards you.</p>	
.3	CONTROL IN	<p>1) Unfasten the earth screw. (use + ScrewDriver)</p> <p>2) Detach the temperature sensor and Humidity sensor.</p> <p>3) Detach the temperature sensor.</p>	

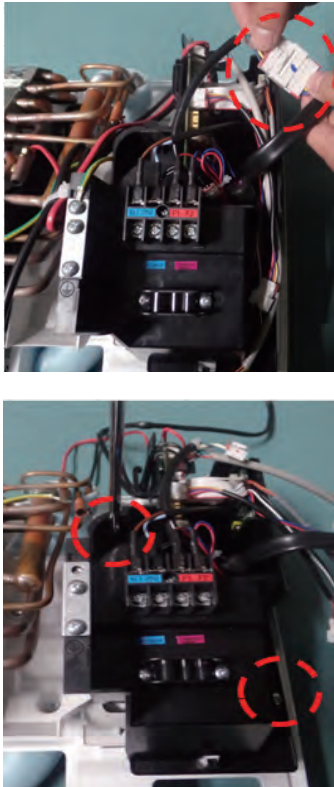
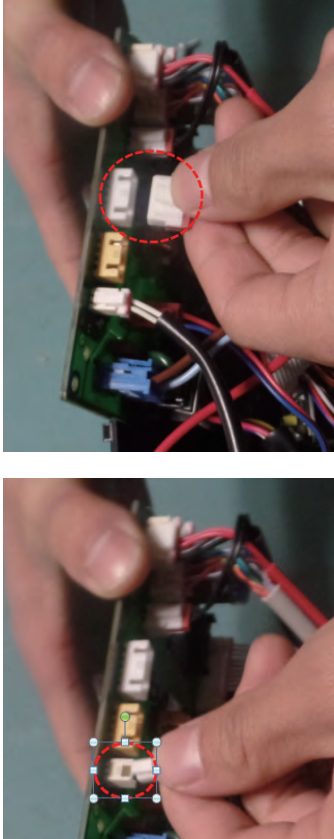

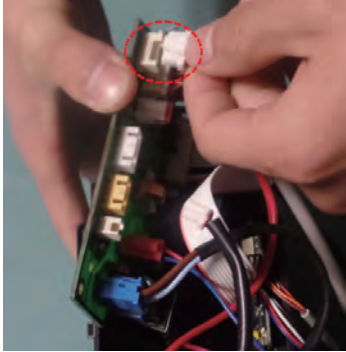
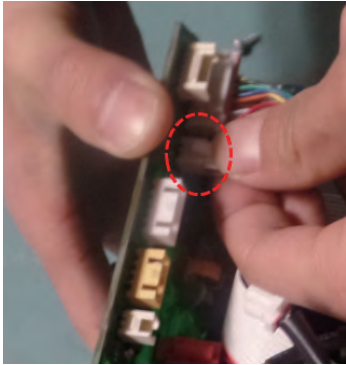
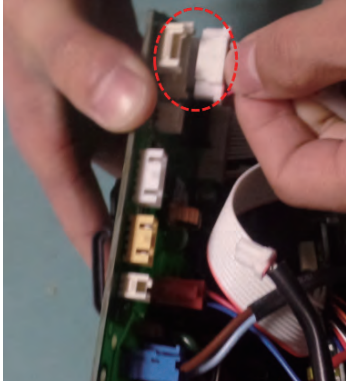
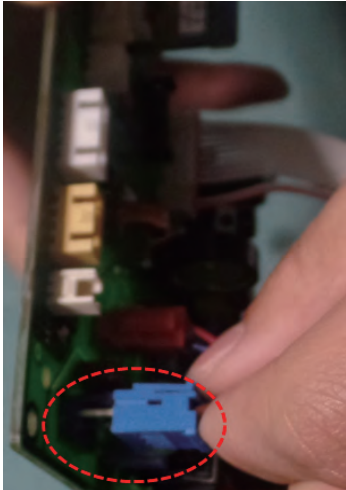

No	Parts	Procedure	Remark
		<p>4) Loosen MOTOR wires(white).</p> <p>5) Take off the CASE-CONTROL from the main frame. (use + Screw Driver)</p>	
4	PBA	<p>1) Loosen the STEP UP/DOWN connector (CN802).</p> <p><b>⚠ Caution</b> When you separate the connector, pull pressing the locking button.</p> <p>2) Loosen the FUSE CHK connector (CN140).</p> <p><b>⚠ Caution</b> When you separate the connector, pull pressing the locking button.</p>	

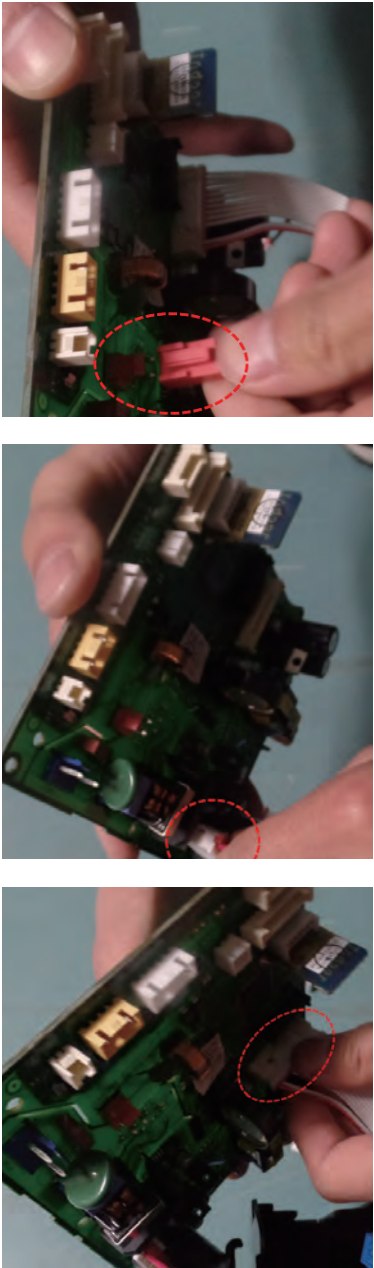
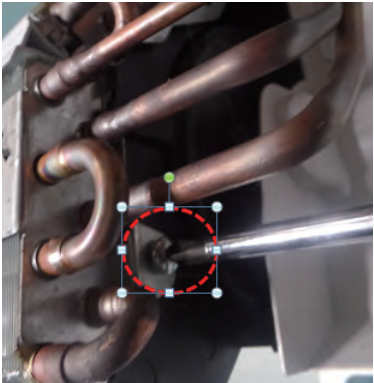

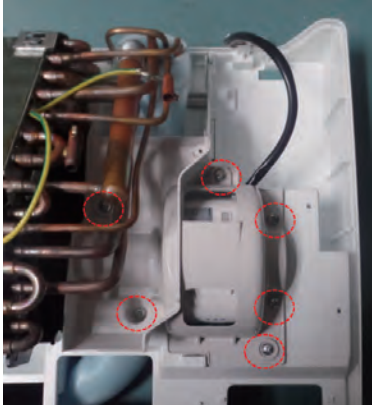

No	Parts	Procedure	Remark
		<p>3) Loosen the EVA IN/OUT connector. (CN403)</p> <p><b>⚠ Caution</b> When you separate the connector, pull pressing the locking button.</p>	
		<p>4) Loosen the Humidity sensor connector (CN401). → Option connector.</p> <p><b>⚠ Caution</b> The terminal is locking type. So, when you separate terminals, pull pressing the button.</p>	
		<p>5) Loosen the DISPLAY connector. (CN501).</p> <p><b>⚠ Caution</b> The terminal is locking type. So, when you separate terminals, pull pressing the button.</p>	
		<p>6) Loosen the POWER connector.</p> <p><b>⚠ Caution</b> When you separate the connector, pull pressing the locking button.</p>	

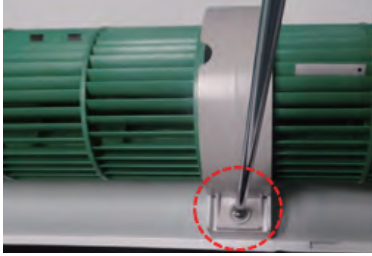
No	Parts	Procedure	Remark
		<p>7) Loosen the COMM wire connector (CN303).</p> <p><b>⚠ Caution</b> When you take off the PBA, don't touch the components. Please hold the PBA both side.</p> <p>8) Loosen the Motor connector(CN701).</p> <p><b>⚠ Caution</b> When you separate the connector, pull pressing the locking button.</p> <p>9) Take off the main PBA from the ASS'Y Control in.</p> <p><b>⚠ Caution</b> When you take off the PBA, don't touch the components. Please hold the PBA both side.</p>	
5	EVAPORATOR	<p>1) Unfasten the screw at the right side. (use + ScrewDriver)</p>	

No	Parts	Procedure	Remark
		2) Unfasten the screw at the left side. (use + ScrewDriver)	
		3) Detach the HOLDER PIPE. (use + Screw Driver)	
		4) Detach the BRACKET-EVAP. (use + Screw Driver)	
		5) Detach the HOLDER EVAP. (use + Screw Driver)	
		6) Loosen 1 fixing earth screw right side. (use + Screw Driver)	

No	Parts	Procedure	Remark
6	FAN MOTOR & CROSS FAN	<p>1) Loosen 6 fixing screws of HOLDER-MOTOR</p> <p>2) unfasten the screw a little. (use + Screw Driver)</p> <p>3) unfasten the screw a little and pull the MOTOR FAN to the right side. (use + Screw Driver)</p> <p>4) Loosen 1 fixing screws of HOLDER-FAN. (use + Screw Driver)</p> <p>5) unfasten the screw a little. (use + Screw Driver)</p>	    

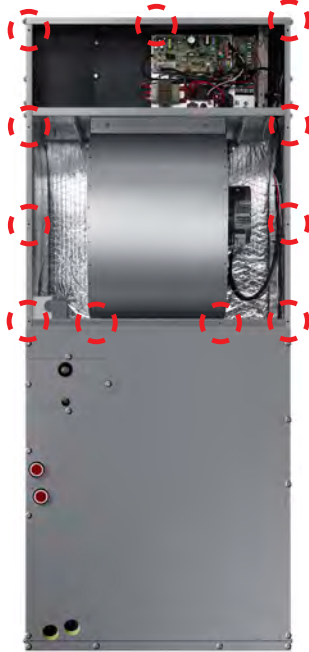
■ MPAH : AC\*\*\*BNZDCH, AC\*\*\*KNZDCH

No	Parts	Procedure	Remark
1	FRONT VIEW	1) Stop the operation of the air conditioner and disconnect the main power supply.	
2	Control-BOX	1) Loosen 11 of the front screw(CCW) and detach the Cabinet Front Up.  2) Disconnect the Connector Wire that is connected to the indoor unit's PBA  3) Unscrew the 1 fixed screws on middle of the PBA and 4 fixed PBA HOLDER, and disassemble the PBA from the indoor unit. (Use + Screw Driver)	 

No	Parts	Procedure	Remark
3	DRAIN PAN	<p>1) Loosen 11 of the front screw(CCW) and detach the Cabinet Front Down.</p> <p>2) Loosen 2 of the Left side screw(CCW).</p> <p>3) Loosen 5 of the front screw(CCW) and detach the 2 Bracket drain and 1 Bracket Low</p> <p>4) Pull the Heat Exchanger and Drain.</p> <p>5) Detach the Drain from indoor Unit.</p>	

No	Parts	Procedure	Remark
4	Heat Exchanger	<p>1) Loosen 11 of the front screw(CCW) and detach the Cabinet Front Down.</p> <p>2) Loosen 2 of the Left side screw(CCW).</p> <p>3) Loosen 5 of the front screw(CCW) and detach the 2 Bracket drain and 1 Bracket Low.</p> <p>4) Disconnect the Connector Wire that is connected to the Heat Exchanger.</p> <p>5) Pull the Heat Exchanger and Drain.</p> <p>6) Detach the Heat Exchanger.</p>	



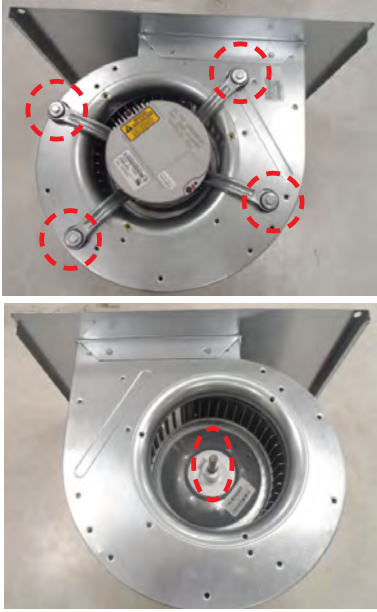

No	Parts	Procedure	Remark
5	FAN & MOTOR (Continues)	<p>1) Loosen 11 of the front screw(CCW) and detach the Cabinet Front Down.</p> <p>2) Loosen 6 of the Front screw(CCW) and detach the Bracket.</p> <p>3) Disconnect the Connector Wire that is connected to the Motor.</p> <p>4) Pull the A'ssy Fan Blower.</p>	   











No	Parts	Procedure	Remark
5	FAN & MOTOR	6) Loosen 4 of the screw and 1 nut on the CASE and Detach the motor and fan.	

### 3-2. Outdoor unit

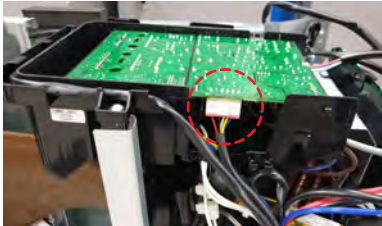

■ AC009/012BXADCH

No.	Parts	Procedure	Remark
1	Common work	1) Loosen each screws and detach the cabi Top cover.	
		2) Loosen screws of the cabi front and detach it.	 
		3) Remove the 4 Cond Bar from the holder of outdoor unit cabinet. * This process is supported by heating models only	



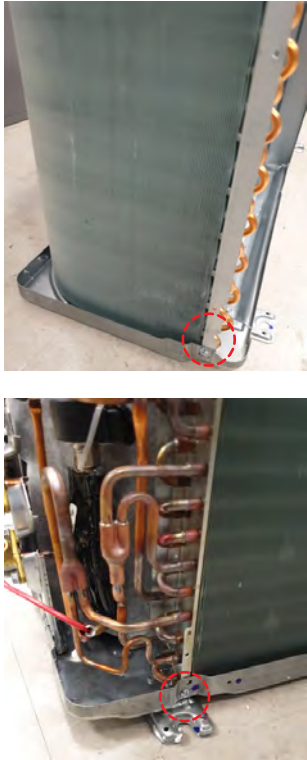

No.	Parts	Procedure	Remark
1	Common work	4) Loosen screws from the Cabi Front Lh and detach it.	
		5) Loosen screws from the Cabi Side Rh and detach it.	 
2	Fan & Motor	1) Detach the Nut Flange like the picture on the right side. (Turn clockwise because the screw is left-handed.) (Use Monkey Spanner.)	

No.	Parts	Procedure	Remark
2	Fan & Motor	2) Detach the Fan Propeller. 3) Loosen 4 fixing screws to detach the Motor. (Use Monkey Spanner.)	
		4) Disconnect the wire between Ass'y Control Out and Motor.	
		5) Loosen fixing bolts and detach the Bracket Motor	
3	Base Heater	1) Loosen fixing screw and deattach the Base Heater	
4	Assy Control Out	1) To remove the Cover control box : Pull the motor wire to allow sufficient space as shown on the right side and then remove the screw.	

No.	Parts	Procedure	Remark
4	Assy Control Out	2) Detach several connectors from the Assy Control Out. 3) Detach several connectors from the PCB of Assy Control Out.	
		1) Release the refrigerant at first. 2) Loosen screw on both sides. 3) Disassemble the pipes in both inlet and outlet with welding torch. 4) Detach the Heat Exchanger.	



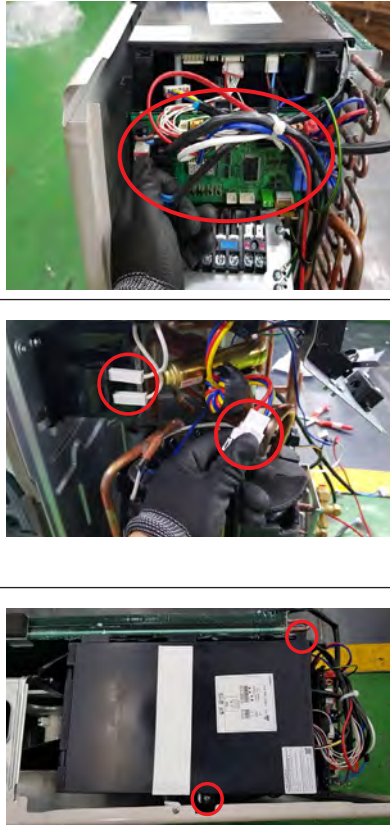

No.	Parts	Procedure	Remark
5	Compressor	1) Loosen the nut and detach the Compressor Lead Wire. (Use Monkey Spanner.)	
		2) Loosen the bolts at the bottom of Compressor like the picture on the right side. (Use Monkey Spanner.)	

■ AC018BXADCH

No.	Parts	Procedure	Remark
1	Cabi Top	1) Unscrew and remove 8 screws on each side of the Cabinet-Top. (Use + Screw Driver)	
2	Ass'y cover control	1) Unscrew and remove a screw of Cover-Control. (Use + Screw Driver)	
3	Outdoor and indoor unit's power cable and communication cable	<p>⚠ <b>Make sure shutting the power off supply before disassembling.</b></p> <p>3) Unscrew the numbers of screws on terminal block and separate power and communication 'Ring' cables from terminal block.</p>	
4	Ass'y cabinet side rh	1) Unscrew and remove 10 screws on Cabinet-side rh. (Use + Screw Driver)	



No.	Parts	Procedure	Remark
5	Ass'y cabinet front	1) Unscrew and remove 7 screws on Assy Cabinet Front. (Use + Screw Driver)	
6	Ass'y control out	<p>1) Disconnect and Separate 5 Connectors of wire from Assy Control Out.</p> <p>2) Separate Comp wire and Reactor wire from each object.  <span style="color: red;">⚠ (When you disconnect BLDC motor connector you have to cut the power off first and disconnect 30 seconds later And Make sure that is impossible to connect and disconnect BLDC motor connector when the power is on)</span></p> <p>3) Unscrew and remove 2 screws on of Assy Control out.</p>	



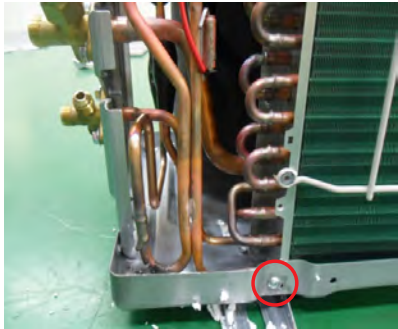

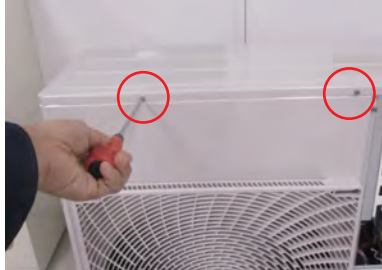

No.	Parts	Procedure	Remark
7	Fan propeller + Motor	1) Take Fan Propeller apart.	
		2) Unscrew and remove 4 screws on Motor to take apart Motor. (Use + Screw Driver)	
8	Ass'y bracket Motor	1) Unscrew and remove 2 screws on to take apart Bracket Motor. (Use + Screw Driver)	
9	Base Heater	1) Loosen fixing screw and deattach the Base Heater	

No.	Parts	Procedure	Remark
10	Heat Exchanger	<ol style="list-style-type: none"><li>1) Purge the Refrigerant first.</li><li>2) Unscrew the fix screw.</li><li>3) Separate the pipe from the Entrance and Exist by using a welder.</li><li>4) Separate Heat Exchanger from Unit.</li></ol> <p><b>⚠ When removing the Compressor, Heat Exchanger, and Pipe, Purge the Refrigerant inside the Compressor completely and remove the pipe with a weld-ing flame.</b></p>	

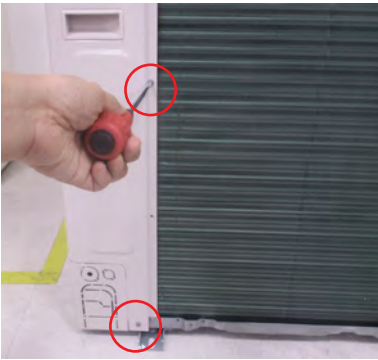

■ AC024BXADCH, AC030BXADCH

No.	Parts	Procedure	Remark
1	Cabinet Front RH	<p><b>⚠ Turn off the power before disassembly necessarily.</b></p> <p>1) Remove 2ea of screws from the Cabinet Front RH and separate it. (Use + Screw Driver)</p>	
2	Cabinet Upper	<p>1) Remove 9ea of screws which are fixed to each side of Cabinet Upper and separate it. (Use + Screw Driver)</p>	
3	Cabinet-Installation Front Part	<p>1) Remove a screw which is fixed to Cabinet-Installation Front Part and separate it. (Use + Screw Driver)</p>	

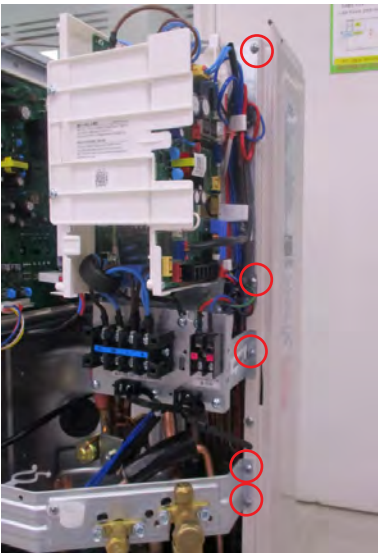
No.	Parts	Procedure	Remark
4	Outdoor Unit Guard	<p>1) Pull out the sensor from the Outdoor Unit Guard and separate it.</p> <p>2) Remove the 4ea of screws which are fixed to Outdoor Unit Guard and separate it. (Use + Screw Driver)</p>	 

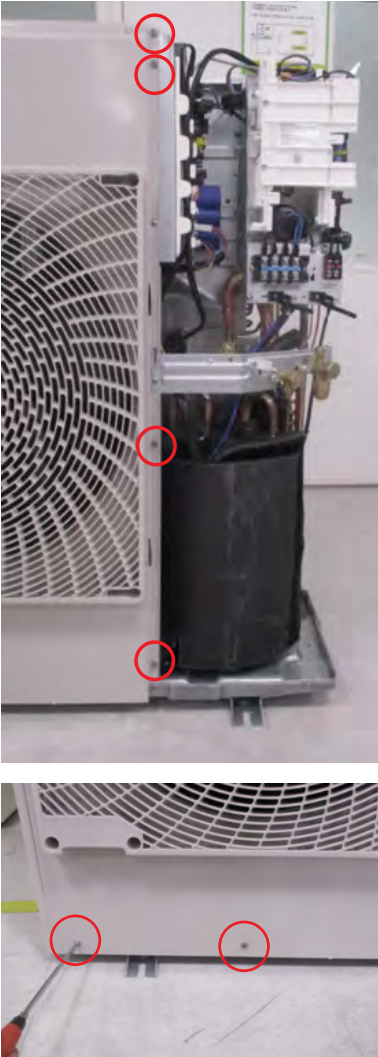
No.	Parts	Procedure	Remark
5	Cabinet Rear RH	<p>1) Pull out the sensor from the Cabinet Rear RH and separate it.</p> <p>2) Remove 9ea of screws which are fixed to each side of Cabinet Rear RH and separate it. (Use + Screw Driver)</p>	   

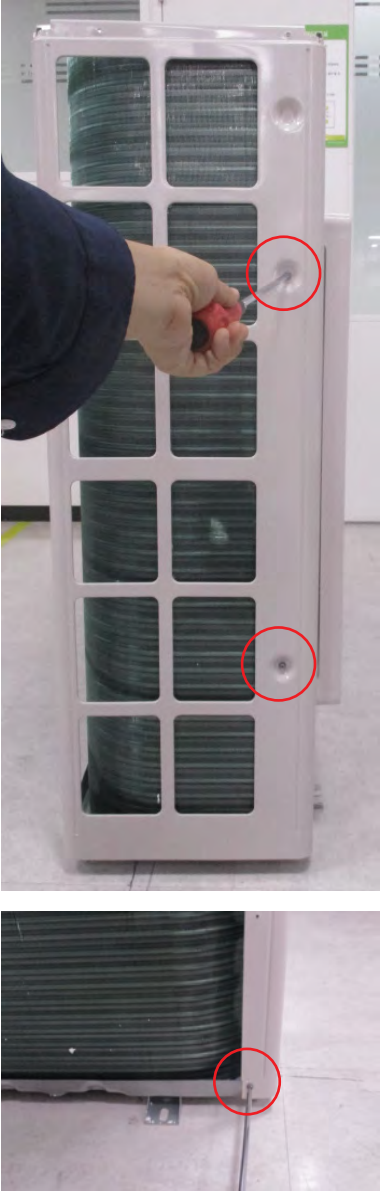

No.	Parts	Procedure	Remark
6	Cabinet-Installation Rear Part	1) Remove a screw from the Cabinet-Installation Rear Part and separate it. (Use +Screw Driver)	
7	Cabinet Front LF	1) Remove 10ea of screws from the Cabinet Front LF and separate it. (Use +Screw Driver)	

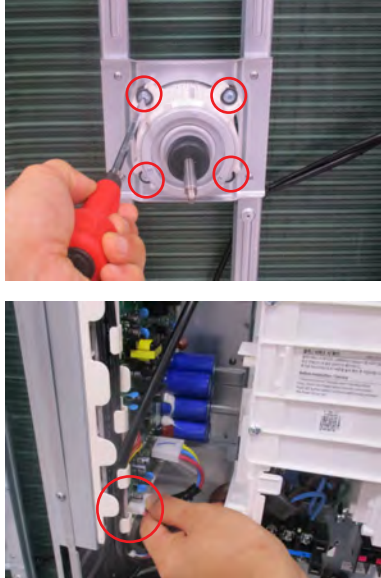
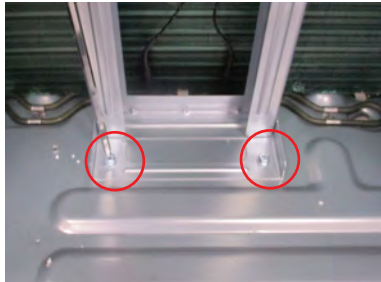
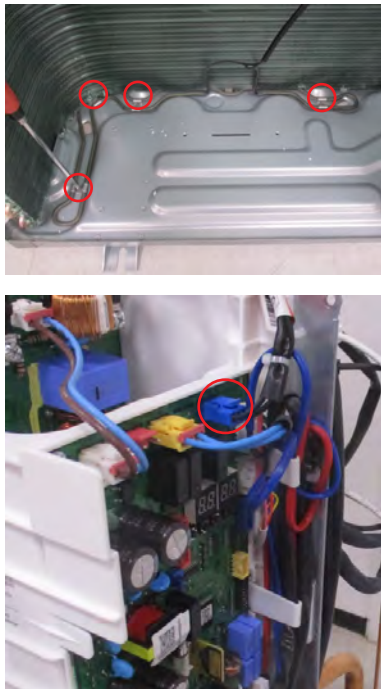
No.	Parts	Procedure	Remark
7	Cabinet Front LF		
8	Fan	<p>1) Remove the 2 hex nuts like the picture on the right side. (Use Hexagon Wrench, Monkey Spanner, Hexagon Socket)</p>	

No.	Parts	Procedure	Remark
9	Motor	1) Separate the Fan Propeller.  2) Remove 8ea of screws which are fixed to Motor. (Use +Screw Driver)  3) Separate the Motor Wire connector from the Outdoor Unit Control Part.	 <p>The top photograph shows a hand using a red screwdriver to remove screws from the motor assembly. Four screws are circled in red. The bottom photograph shows the motor wire connector being disconnected from the control board, with the connector circled in red.</p>
10	Bracket Motor	1) Remove 2ea of screws from the Bracket Motor and separate it. (Use +Screw Driver)	 <p>The photograph shows the motor bracket with two screws circled in red, indicating they are to be removed.</p>
11	Base Heater (※ AC024BXADCH Only)	1) Remove 4ea of screws from the Base heater and separate it. (Use +Screw Driver)  2) Separate the Base heater Wire connector from the Outdoor Unit Control Part.	 <p>The top photograph shows the base heater with four screws circled in red. The bottom photograph shows the base heater wire connector being disconnected from the control board, with the connector circled in red.</p>

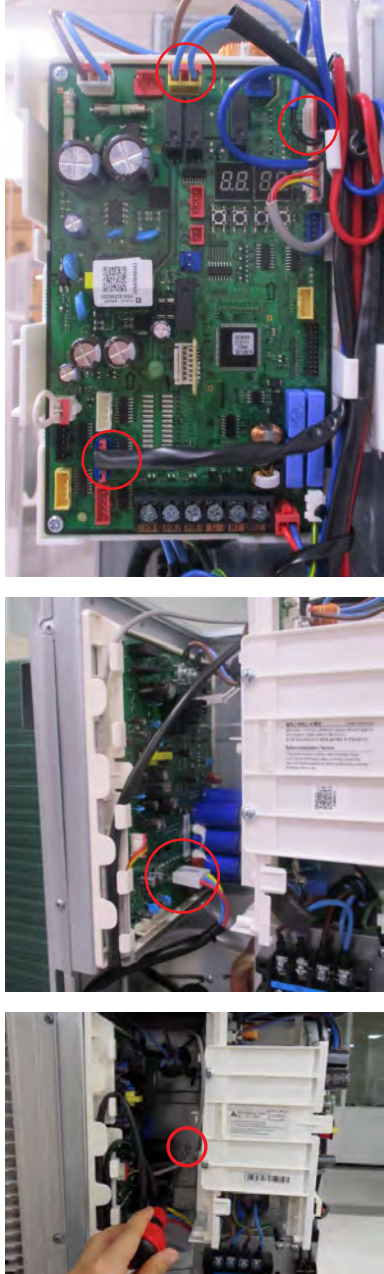

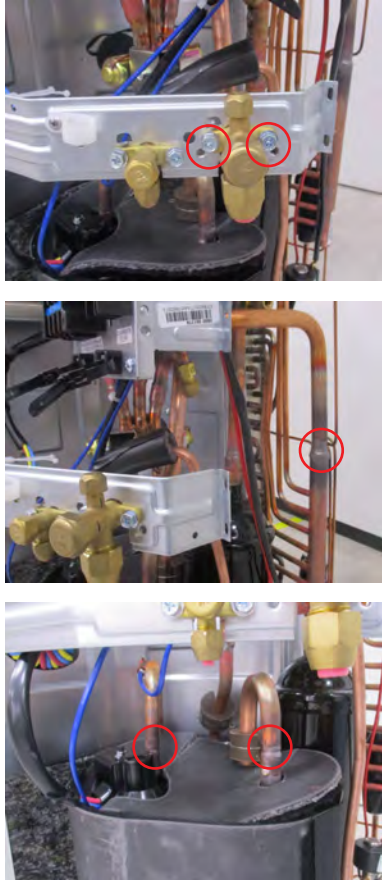

No.	Parts	Procedure	Remark
12	Control Part	<p>1) Separate the 4 connectors from the Outdoor Unit Control part.</p> <p>2) Remove the 2ea screw which is fixed to Control Part. (Use +Screw Driver)</p> <p>3) Separate the Control Part.</p>	

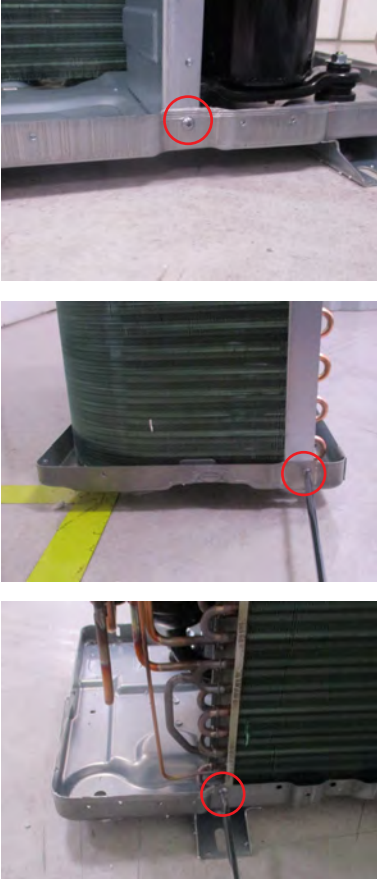

No.	Parts	Procedure	Remark
13	4 Way Valve	<p>1) First, discharge the refrigerant.</p> <p>2) Remove 2ea of screws which are fixed to Service Valve. (Use +Screw Driver)</p> <p>3) Separate the inlet and outlet pipes by welding torch.</p> <p><b>⚠ If you separate the Compressor, Heat Exchanger or Pipe, please fully discharge refrigerant in the Compressor and then separate the Pipe by welding torch.</b></p>	
14	EEV Valve	<p>1) Remove 2ea of screws which are fixed to Service Valve and separate it. (Use +Screw Driver)</p> <p>2) Separate the inlet and outlet pipes by welding torch</p>	



No.	Parts	Procedure	Remark
15	Compressor	<p>1) Remove a hex nut from the end of Cover and separate it (Use Hexagon Wrench, Monkey Spanner, Hexagon Socket)</p> <p>2) Separate the Felt Compressor.</p> <p>3) Remove the 3 hex nuts from the bottom of Compressor like the picture on the right side. (Use Hexagon Wrench, Monkey Spanner, Hexagon Socket)</p>	

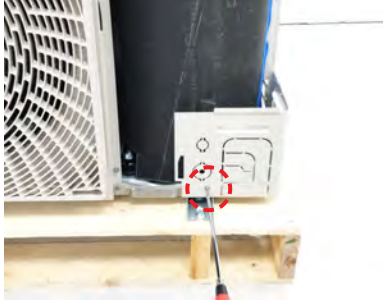

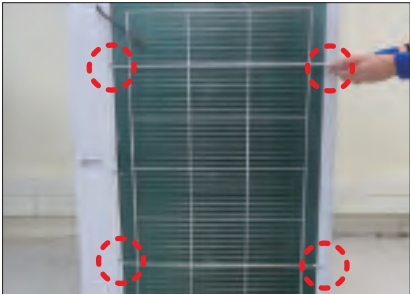
No.	Parts	Procedure	Remark
16	Condenser Connection Part	1) Remove 3ea of screws which are fixed to each side of Condenser Connection Part and separate it. (Use + Screw Driver)	

■ AC036/042/048BXADCHA

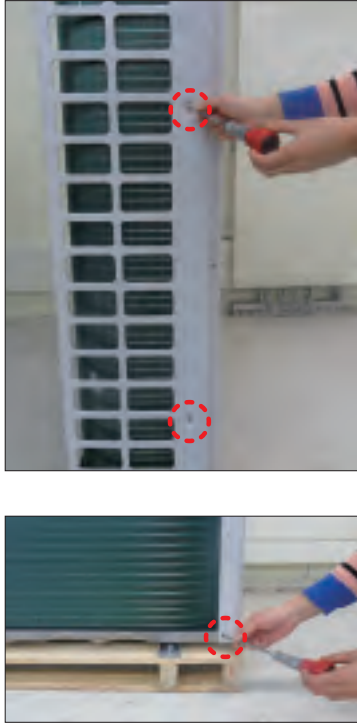

No.	Parts	Procedure	Remark
1	Cabinet Front RH	<p><b>⚠ Turn off the power before disassembly necessarily.</b></p> <p>1) Remove the 2 screws from the Cabinet Front RH and separate it. (Use + Screw Driver)</p>	
2	Cabinet Upper	<p>1) Remove the 9 screws which is fixed to each side of Cabinet Upper and separate it.(Use + Screw Driver)</p>	
3	Cabinet-Installation Front Part	<p>1) Remove the 1 screw which is fixed to Cabinet-Installation Front Part and separate it.(Use + Screw Driver)</p>	

No.	Parts	Procedure	Remark
4	Outdoor Unit Guard	<p>1) Pull out the sensor from the Outdoor Unit Guard and separate it.</p> <p>2) Remove the 4 screws which is fixed to Outdoor Unit Guard and separate it. (Use + Screw Driver)</p>	 
5	Cabinet Rear RH	<p>1) Pull out the sensor from the Cabinet Rear RH and separate it.</p> <p>2) Remove the 4 screws which is fixed to each side of Cabinet Rear RH and separate it. (Use + Screw Driver)</p>	 



No.	Parts	Procedure	Remark
6	Cabinet-Installation Rear Part	1) Remove the 1 screw from the Cabinet-Installation Rear Part and separate it.(Use +Screw Driver)	
7	Cabinet Front LF	1) Remove the 9 screws from the Cabinet Front LF and separate it. (Use +Screw Driver)	

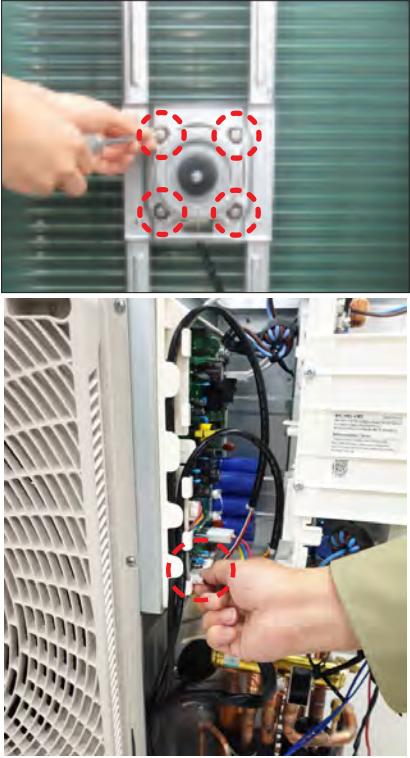



No.	Parts	Procedure	Remark
7	Cabinet Front LF		
8	Fan	1) Remove the 2 fixing nuts like the picture on the right side. (Use Hexagon Wrench, Monkey Spanner, Hexagon Socket)	

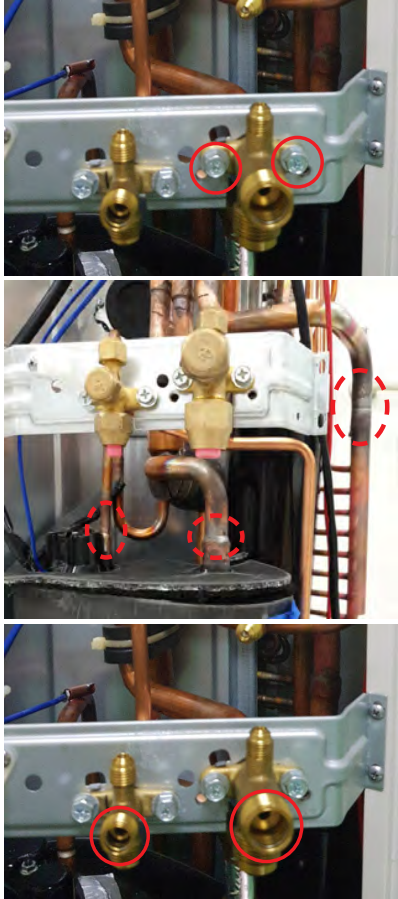

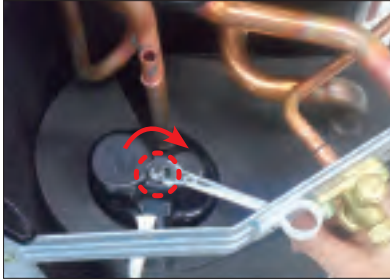

No.	Parts	Procedure	Remark
9	Motor	<ol style="list-style-type: none"> <li>1) Separate the Fan Propeller.</li> <li>2) Remove the 8 screws which is fixed to Motor. (Use +Screw Driver)</li> <li>3) Separate the Motor Wire connector from the Outdoor Unit Control Part.</li> </ol>	
10	Bracket Motor	<ol style="list-style-type: none"> <li>1) Remove the 2 screws from the Bracket Motor and separate it. (Use +Screw Driver)</li> </ol>	

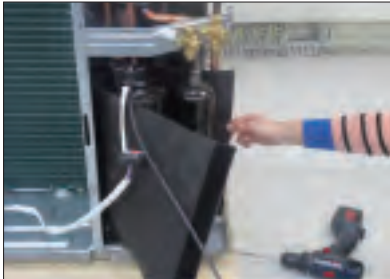

No.	Parts	Procedure	Remark
12	4 Way Valve	<p>1) First, discharge the refrigerant.</p> <p>2) Remove the 2 screw which is fixed to Service Valve. (Use +Screw Driver)</p> <p>3) Separate the inlet and outlet pipes by welding torch.</p> <p><b>⚠ If you separate the Compressor, Heat Exchanger or Pipe, please fully discharge refrigerant in the Compressor and then separate the Pipe by welding torch.</b></p>	
13	EEV Valve	<p>1) Remove the 2 screws which is fixed to Service Valve and separate it. (Use +Screw Driver)</p> <p>2) Separate the inlet and outlet pipes by welding torch</p>	

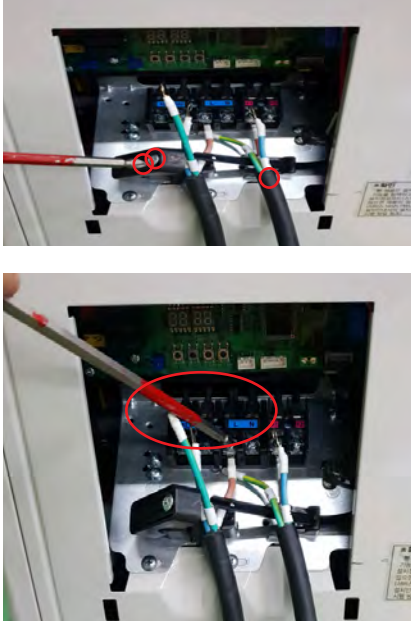

No.	Parts	Procedure	Remark
14	Compressor	<p>1) Remove the 1 fixing nut from the end of Cover and separate it. (Use Hexagon Wrench, Monkey Spanner, Hexagon Socket)</p> <p>2) Separate the Felt Compressor.</p> <p>3) Remove the 3 bolts from the bottom of Compressor like the picture on the right side. (Use Hexagon Wrench, Monkey Spanner, Hexagon Socket)</p>	   

■ AC018BXSCCC

No	Parts	Procedure	Remark
1	Cabi Top	1) Unscrew and remove 8 screws on each side of the Cabinet-Top. (Use + Screw Driver)	
2	Ass'y cover control	1) Unscrew and remove a screw of Cover-Control. (Use + Screw Driver)	
3	Outdoor and indoor unit's power cable and communication cable	<p>⚠ Make sure shutting the power off supply before disassembling</p> <p>1) Unscrew 2 fix screws under cable holders and remove.</p> <p>2) Get rid of cable tie of communication cable.</p> <p>3) Unscrew the numbers of screws on terminal block and separate power and communication 'Ring' cables from terminal block.</p>	

No	Parts	Procedure	Remark
4	Ass'y cabinet side RH	1) Unscrew and remove 9 screws on Cabinet-side rh. (Use + Screw Driver)	
5	Ass'y cabinet front	1) Unscrew and remove 8 screws on Assy Cabinet Front. (Use + Screw Driver)	



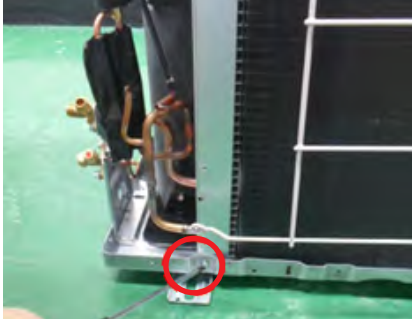

No	Parts	Procedure	Remark
6	Ass'y control out	<p>1) Disconnect and Separate 5 Connectors of wire from Assy Control Out.</p> <p>2) Separate Comp wire and Reactor wire from each object.</p> <p>⚠ (When you disconnect BLDC motor connector you have to cut the power off first and disconnect 30 seconds later And Make sure that is impossible to connect and disconnect BLDC motor connector when the power is on)</p> <p>3) Unscrew and remove 2 screws on of Assy Control out.</p>	

No	Parts	Procedure	Remark
7	Fan propeller + Motor	1) Take Fan Propeller apart.  2) Unscrew and remove 4 screws on Motor to take apart Motor. (Use + Screw Driver)	
8	Ass'y bracket motor	1) Unscrew and remove 2 screws on to take apart Bracket Motor. (Use + Screw Driver)	
9	Belt heater	1) Detach the spring of belt heater to remove from compressor (Belt heater connector is already removed from the Control part in the procedure 1 of No. 6.)	





No	Parts	Procedure	Remark
10	Heat Exchanger	<p>1) Purge the Refrigerant first.</p> <p>2) Unscrew the fix screw.</p> <p>3) Separate the pipe from the Entrance and Exist by using a welder.</p> <p>4) Separate Heat Exchanger from Unit.</p> <p><b>⚠ When removing the Compressor, Heat Exchanger, and Pipe, Purge the Refrigerant inside the Compressor completely and remove the pipe with a weld-ing flame.</b></p>	

■ AC024BXSCC

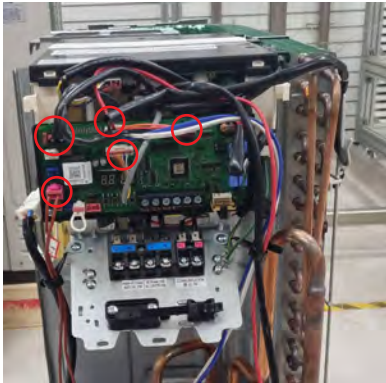
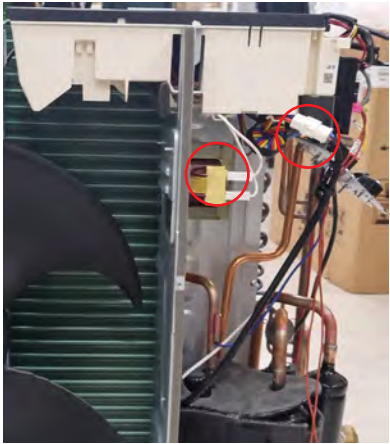

No.	Parts	Procedure	Remark
1	Cabi Top	1) Unscrew and remove 8 screws on each side of the Cabinet-Top. (Use + Screw Driver)	
2	Ass'y cover control	1) Unscrew and remove a screw of Cover-Control. (Use + Screw Driver)	
3	Outdoor and indoor unit's power cable and communication cable	<p>⚠ Make sure shutting the power off supply before disassembling.</p> <p>3) Unscrew the numbers of screws on terminal block and separate power and communication 'Ring' cables from terminal block.</p>	
4	Ass'y cabinet side rh	1) Unscrew and remove 10 screws on Cabinet-side rh. (Use + Screw Driver)	

No.	Parts	Procedure	Remark
5	Ass'y cabinet front	1) Unscrew and remove 7 screws on Assy Cabinet Front. (Use + Screw Driver)	

No.	Parts	Procedure	Remark
6	Ass'y control out	1) Disconnect and Separate 5 Connectors of wire from Assy Control Out.	
		2) Separate Comp wire and Reactor wire from each object. ⚠ (When you disconnect BLDC motor connector you have to cut the power off first and disconnect 30 seconds later And Make sure that is impossible to connect and disconnect BLDC motor connector when the power is on)	
		3) Unscrew and remove 2 screws on of Assy Control out.	

No.	Parts	Procedure	Remark
7	Fan propeller + Motor	1) Take Fan Propeller apart.	
		2) Unscrew and remove 4 screws on Motor to take apart Motor. (Use + Screw Driver)	
8	Ass'y bracket Motor	1) Unscrew and remove 2 screws on to take apart Bracket Motor. (Use + Screw Driver)	
9	Belt heater	Detach the spring of belt heater to remove from compressor (Belt heater connector is already removed from the Control part in the procedure 1 of No. 6.)	
10	Heat Exchanger	1) Purge the Refrigerant first. 2) Unscrew the fix screw. 3) Separate the pipe from the Entrance and Exist by using a welder. 4) Separate Heat Exchanger from Unit. ⚠ When removing the Compressor, Heat Exchanger, and Pipe, Purge the Refrigerant inside the Compressor completely and remove the pipe with a weld-ing flame.	

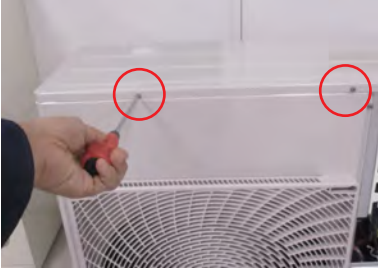

## ■ AC030/036BXSCC

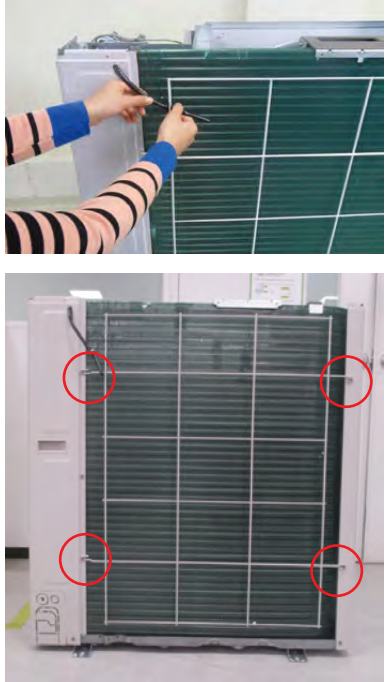

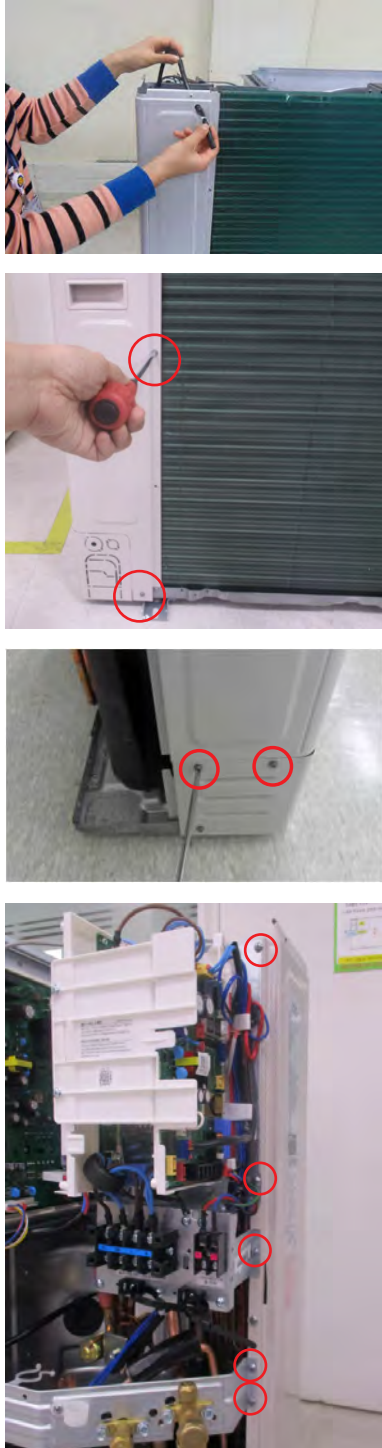
No.	Parts	Procedure	Remark
1	Cabinet Front RH	<p><b>⚠ Turn off the power before disassembly necessarily.</b></p> <p>1) Remove 2ea of screws from the Cabinet Front RH and separate it. (Use + Screw Driver)</p>	
2	Cabinet Upper	<p>1) Remove 9ea of screws which are fixed to each side of Cabinet Upper and separate it. (Use + Screw Driver)</p>	
3	Cabinet-Installation Front Part	<p>1) Remove a screw which is fixed to Cabinet-Installation Front Part and separate it. (Use + Screw Driver)</p>	



No.	Parts	Procedure	Remark
4	Outdoor Unit Guard	<p>1) Pull out the sensor from the Outdoor Unit Guard and separate it.</p> <p>2) Remove the 4ea of screws which are fixed to Outdoor Unit Guard and separate it. (Use + Screw Driver)</p>	

No.	Parts	Procedure	Remark
5	Cabinet Rear RH	<p>1) Pull out the sensor from the Cabinet Rear RH and separate it.</p> <p>2) Remove 9ea of screws which are fixed to each side of Cabinet Rear RH and separate it. (Use + Screw Driver)</p>	

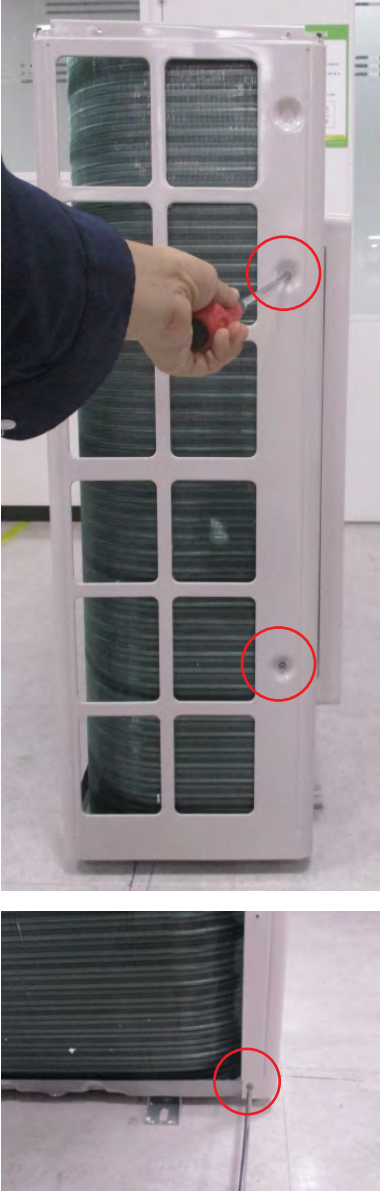

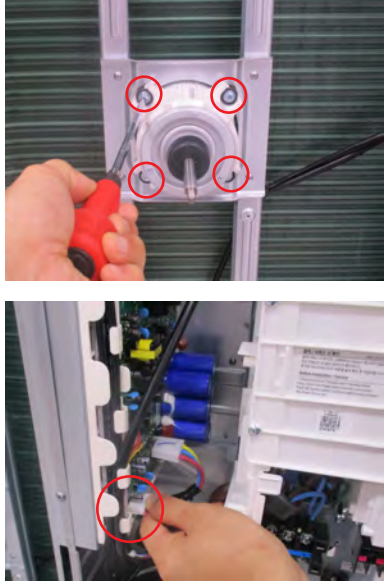

No.	Parts	Procedure	Remark
6	Cabinet-Installation Rear Part	1) Remove a screw from the Cabinet-Installation Rear Part and separate it. (Use +Screw Driver)	
7	Cabinet Front LF	1) Remove 10ea of screws from the Cabinet Front LF and separate it. (Use +Screw Driver)	

No.	Parts	Procedure	Remark
7	Cabinet Front LF		
8	Fan	<p>1) Remove the 2 hex nuts like the picture on the right side. (Use Hexagon Wrench, Monkey Spanner, Hexagon Socket)</p>	

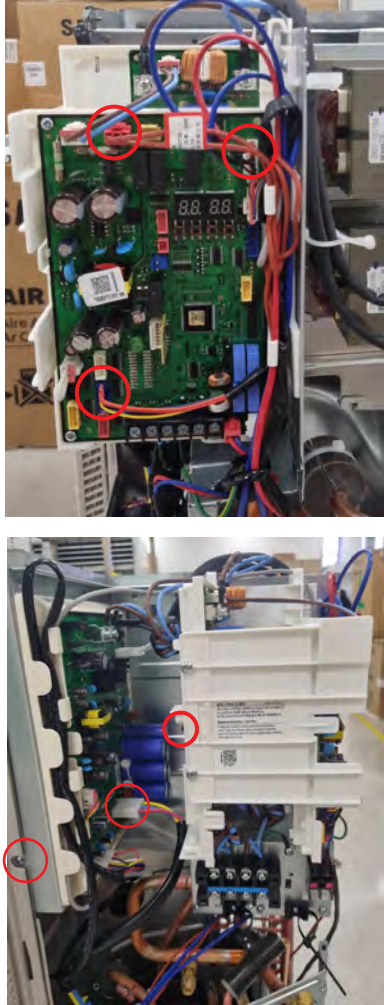
No.	Parts	Procedure	Remark
9	Motor	1) Separate the Fan Propeller.  2) Remove 8ea of screws which are fixed to Motor. (Use +Screw Driver)  3) Separate the Motor Wire connector from the Outdoor Unit Control Part.	
10	Bracket Motor	1) Remove 2ea of screws from the Bracket Motor and separate it. (Use +Screw Driver)	

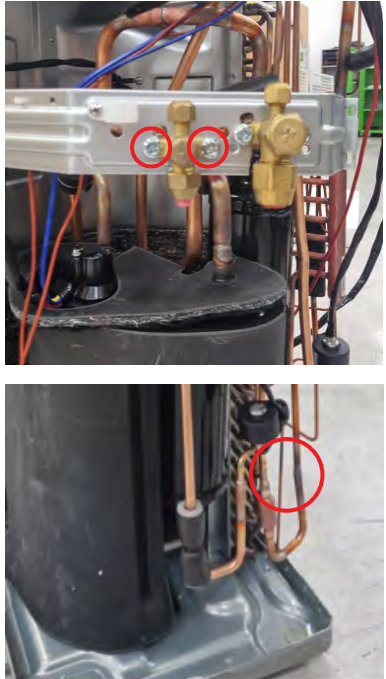

No.	Parts	Procedure	Remark
11	Control Part	<p>1) Separate the 4 connectors from the Outdoor Unit Control part.</p> <p>2) Remove the 2ea screw which is fixed to Control Part. (Use +Screw Driver)</p> <p>3) Separate the Control Part.</p>	

No.	Parts	Procedure	Remark
12	4 Way Valve	<p>1) First, discharge the refrigerant.</p> <p>2) Remove 2ea of screws which are fixed to Service Valve. (Use +Screw Driver)</p> <p>3) Separate the inlet and outlet pipes by welding torch.</p> <p><b>⚠ If you separate the Compressor, Heat Exchanger or Pipe, please fully discharge refrigerant in the Compressor and then separate the Pipe by welding torch.</b></p>	
13	EEV Valve	<p>1) Remove 2ea of screws which are fixed to Service Valve and separate it. (Use +Screw Driver)</p> <p>2) Separate the inlet and outlet pipes by welding torch</p>	

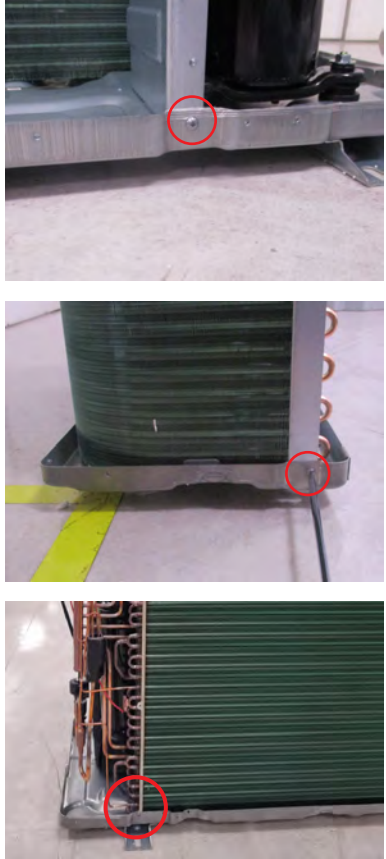

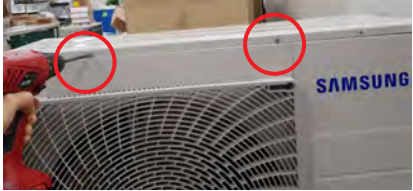

No.	Parts	Procedure	Remark
14	Compressor * Removal of belt heater included	<ol style="list-style-type: none"> <li>1) Remove a hex nut from the end of Cover and separate it (Use Hexagon Wrench, Monkey Spanner, Hexagon Socket)</li>   <li>2) Separate the Felt Compressor.</li>   <li>3) Detach the spring of belt heater to remove from compressor (Belt heater connector is already removed from the Control part in the procedure 1 of No. 11.)</li>   <li>4) Remove the 3 hex nuts from the bottom of Compressor like the picture on the right side. (Use Hexagon Wrench, Monkey Spanner, Hexagon Socket)</li> </ol>	



No.	Parts	Procedure	Remark
15	Condenser Connection Part	1) Remove 3ea of screws which are fixed to each side of Condenser Connection Part and separate it. (Use + Screw Driver)	

## ■ AC030/036BXSCCH



No.	Parts	Procedure	Remark
1	Cabinet Front RH	<p><b>⚠ Turn off the power before disassembly necessarily.</b></p> <p>1) Remove the 2 screws from the Cabinet Front RH and separate it. (Use + Screw Driver)</p>	
2	Cabinet Upper	1) Remove the 9 screws which is fixed to each side of Cabinet Upper and separate it.(Use + Screw Driver)	
3	Cabinet-Installation Front Part	1) Remove the 1 screw which is fixed to Cabinet-Installation Front Part and separate it.(Use + Screw Driver)	

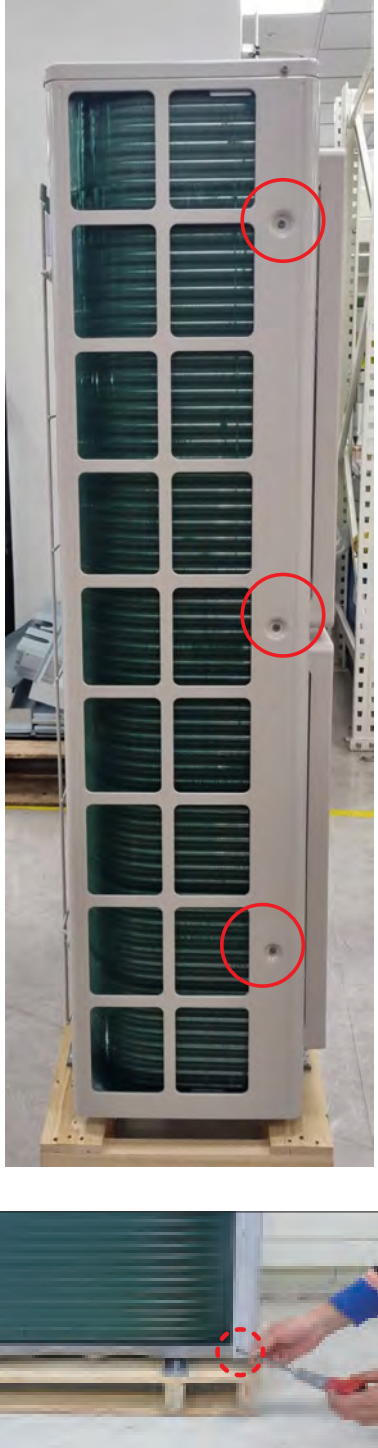

No.	Parts	Procedure	Remark
4	Outdoor Unit Guard	<p>1) Pull out the sensor from the Outdoor Unit Guard and separate it.</p> <p>2) Remove the 4 screws which is fixed to Outdoor Unit Guard and separate it. (Use + Screw Driver)</p>	 
5	Cabinet Rear RH	<p>1) Pull out the sensor from the Cabinet Rear RH and separate it.</p> <p>2) Remove the 4 screws which is fixed to each side of Cabinet Rear RH and separate it. (Use + Screw Driver)</p>	 

No.	Parts	Procedure	Remark
6	Cabinet-Installation Rear Part	1) Remove the 1 screw from the Cabinet-Installation Rear Part and separate it.(Use +Screw Driver)	
7	Cabinet Front LF	1) Remove the 10 screws from the Cabinet Front LF and separate it. (Use +Screw Driver)	

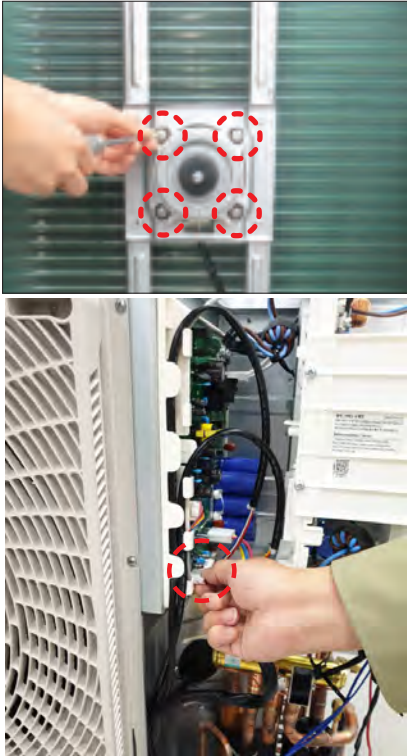
No.	Parts	Procedure	Remark
7	Cabinet Front LF		

No.	Parts	Procedure	Remark
8	Fan	1) Remove the 2 fixing nuts like the picture on the right side. (Use Hexagon Wrench, Monkey Spanner, Hexagon Socket)	
9	Motor	1) Separate the Fan Propeller. 2) Remove the 8 screws which is fixed to Motor. (Use +Screw Driver) 3) Separate the Motor Wire connector from the Outdoor Unit Control Part.	
10	Bracket Motor	1) Remove the 2 screws from the Bracket Motor and separate it. (Use +Screw Driver)	



No.	Parts	Procedure	Remark
11	Base Heater	<p>1) Remove 4ea pf screws from the Base heater and separate it. (Use + Screw Driver)</p> <p>2) Seperate the Base heater Wire connector from the Outdoor Unit Control Part.</p>	

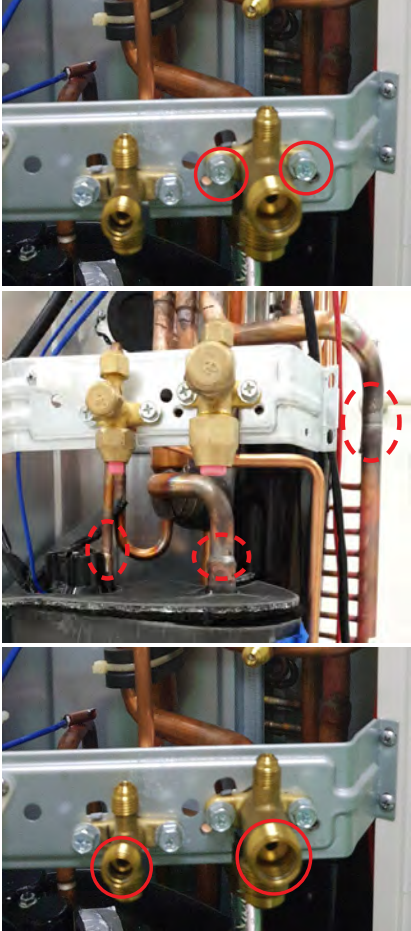

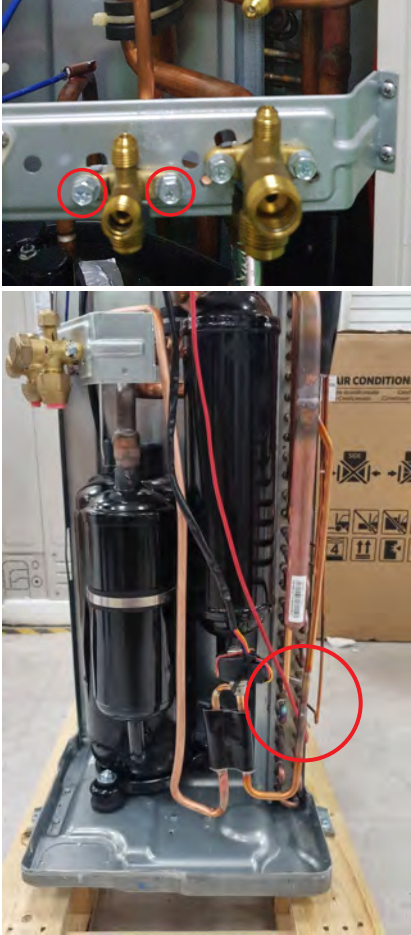
No.	Parts	Procedure	Remark
13	4 Way Valve	<p>1) First, discharge the refrigerant.</p> <p>2) Remove the 2 screw which is fixed to Service Valve. (Use +Screw Driver)</p> <p>3) Separate the inlet and outlet pipes by welding torch.</p> <p>⚠ If you separate the Compressor, Heat Exchanger or Pipe, please fully discharge refrigerant in the Compressor and then separate the Pipe by welding torch.</p>	

No.	Parts	Procedure	Remark
14	EEV Valve	<p>1) Remove the 2 screws which is fixed to Service Valve and separate it. (Use +Screw Driver)</p> <p>2) Separate the inlet and outlet pipes by welding torch</p>	

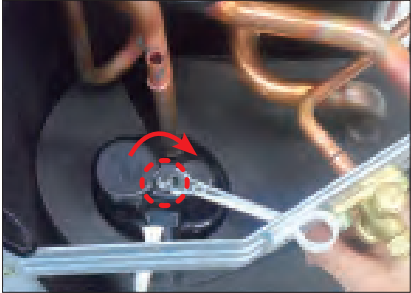

No.	Parts	Procedure	Remark
15	Compressor	<p>1) Remove the 1 fixing nut from the end of Cover and separate it. (Use Hexagon Wrench, Monkey Spanner, Hexagon Socket)</p> <p>2) Separate the Felt Compressor.</p> <p>3) Remove the 3 bolts from the bottom of Compressor like the picture on the right side. (Use Hexagon Wrench, Monkey Spanner, Hexagon Socket)</p>	  

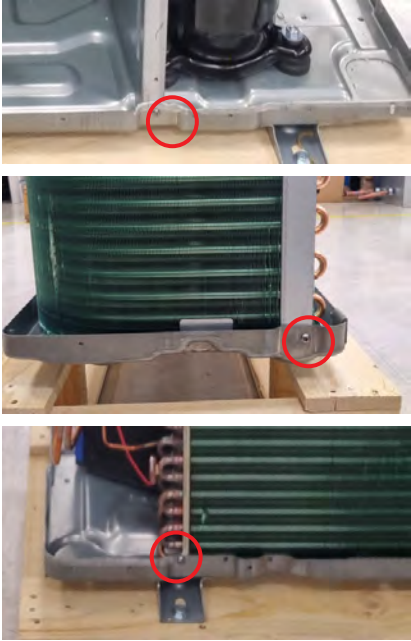
No.	Parts	Procedure	Remark
16	Condenser Connection Part	1) Remove 3ea of screws which are fixed to each side of Condenser Connection Part and separate it. (Use + Screw Driver.)	

## 4. Troubleshooting

### 4-1. Setting an indoor unit address and installation option

- ▶ Set the indoor unit address and installation option with remote controller option.  
Set the each option separately since you cannot set the ADDRESS setting and indoor unit installation setting option at the same time. You need to set twice when setting indoor unit address and installation option.

#### 4-1-1. The procedure of setting option

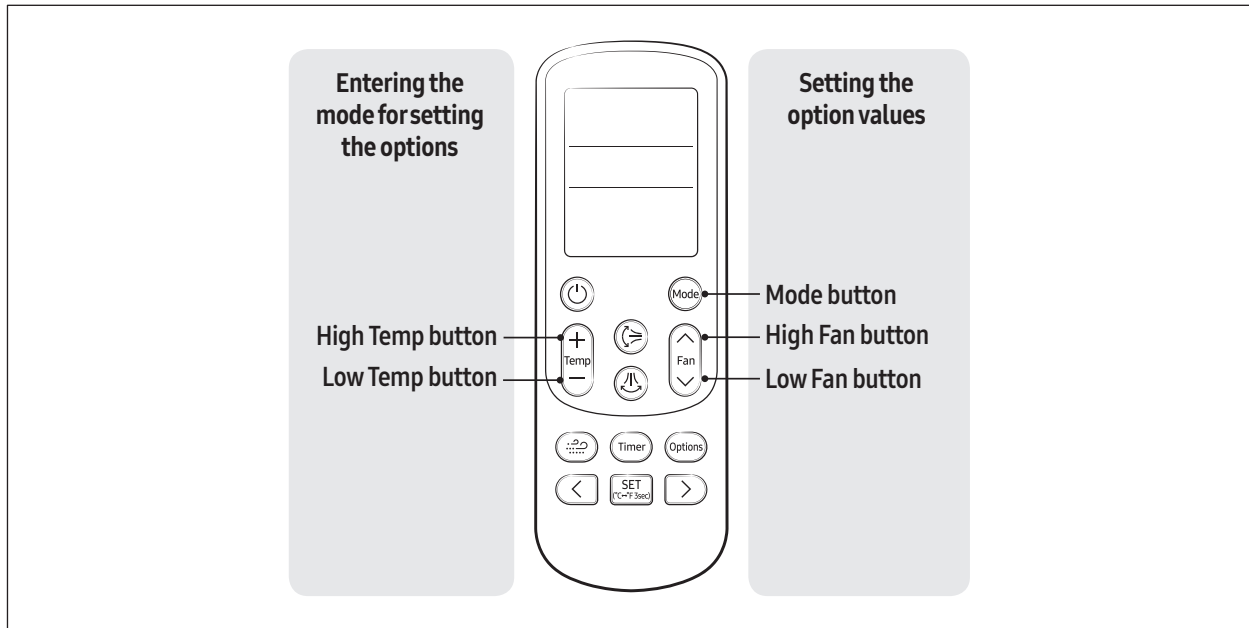

#### Step 1 Entering mode for option setting.

1. Remove batteries from the remote controller.
2. Insert the batteries while you press [+ Temperature] and [- Temperature] button at the same time.
3. Check if you have entered the option setting status.



#### Step 2 Option setting procedure. (The option setting procedure is the same for other models.)







After entering the option setting status, select the option as listed below.



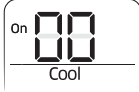

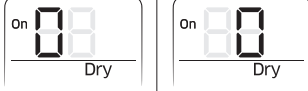

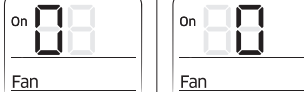
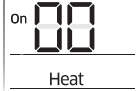
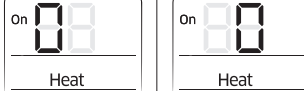

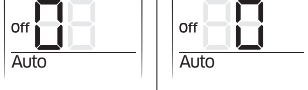



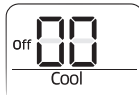



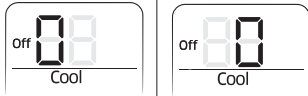









- Option setting is available from SEG1 to SEG 24.
- SEG1, SEG7, SEG13, SEG19 are not set as page option.
- Set the SEG2~SEG6, SEG8~SEG12 in the ON status and SEG14~18, SEG20~24 in the OFF status.

SEG1	SEG2	SEG3	SEG4	SEG5	SEG6	SEG7	SEG8	SEG9	SEG10	SEG11	SEG12	On (SEG1~12)	Off (SEG13~24)
0	X	X	X	X	X	1	X	X	X	X	X		
SEG13	SEG14	SEG15	SEG16	SEG17	SEG18	SEG19	SEG20	SEG21	SEG22	SEG23	SEG24		
2	X	X	X	X	X	3	X	X	X	X	X		

### 4-1-2. The procedure of setting option

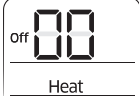
Option setting	Status
<p>1. Setting SEG2, SEG3 option                      Press Low Fan button(∨) to enter SEG2 value .                      Press High Fan button(∧) to enter SEG3 value .                      Each time you press the button,  →  → ...  →  will be selected in rotation .</p>	 <p style="text-align: center;">SEG2                      SEG3</p>
<p>2. Setting Cool mode   Press Mode button to be changed to Cool mode in the ON status .</p>	
<p>3. Setting SEG4, SEG5 option                      Press Low Fan button(∨) to enter SEG4 value .                      Press High Fan button(∧) to enter SEG5 value .                      Each time you press the button,  →  → ...  →  will be selected in rotation .</p>	 <p style="text-align: center;">SEG4                      SEG5</p>
<p>4. Setting Dry mode   Press Mode button to be changed to DRY mode in the ON status .</p>	
<p>5. Setting SEG6, SEG8 option                      Press Low Fan button(∨) to enter SEG6 value .                      Press High Fan button(∧) to enter SEG8 value .                      Each time you press the button,  →  → ...  →  will be selected in rotation .</p>	 <p style="text-align: center;">SEG6                      SEG8</p>
<p>6. Setting Fan mode   Press Mode button to be changed to FAN mode in the ON status .</p>	
<p>7. Setting SEG9, SEG10 option                      Press Low Fan button(∨) to enter SEG9 value .                      Press High Fan button(∧) to enter SEG10 value .                      Each time you press the button,  →  → ...  →  will be selected in rotation .</p>	 <p style="text-align: center;">SEG9                      SEG10</p>
<p>8. Setting Heat mode   Press Mode button to be changed to HEAT mode in the ON status .</p>	
<p>9. Setting SEG11, SEG12 option                      Press Low Fan button(∨) to enter SEG11 value .                      Press High Fan button(∧) to enter SEG12 value .                      Each time you press the button,  →  → ...  →  will be selected in rotation .</p>	 <p style="text-align: center;">SEG11                      SEG12</p>
<p>10. Setting Auto mode   Press Mode button to be changed to AUTO mode in the OFF status.</p>	
<p>11. Setting SEG14, SEG15 option                      Press Low Fan button(∨) to enter SEG14 value .                      Press High Fan button(∧) to enter SEG15 value .                      Each time you press the button,  →  → ...  →  will be selected in rotation.</p>	 <p style="text-align: center;">SEG14                      SEG15</p>

### The procedure of setting option (cont.)

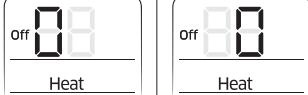
Option setting	Status
<p>12. Setting Cool mode</p> <p> Press Mode button to be change to Cool mode in the OFF status.</p>	
<p>13. Setting SEG16, SEG17 option</p> <p>Press Low Fan button(∨) to enter SEG16 value.</p> <p>Press High Fan button(∧) to enter SEG17 value.</p> <p>Each time you press the button,  →  → ...  →  will be selected in rotation.</p>	 <p style="text-align: center;">SEG16                      SEG17</p>
<p>14. Setting Dry mode</p> <p> Press Mode button to be change to Dry mode in the OFF status.</p>	
<p>15. Setting SEG18, SEG20 option</p> <p>Press Low Fan button(∨) to enter SEG18 value.</p> <p>Press High Fan button(∧) to enter SEG20 value.</p> <p>Each time you press the button,  →  → ...  →  will be selected in rotation.</p>	 <p style="text-align: center;">SEG18                      SEG20</p>
<p>16. Setting Fan mode</p> <p> Press Mode button to be change to Fan mode in the OFF status.</p>	
<p>17. Setting SEG21, SEG22 option</p> <p>Press Low Fan button(∨) to enter SEG21 value.</p> <p>Press High Fan button(∧) to enter SEG22 value.</p> <p>Each time you press the button,  →  → ...  →  will be selected in rotation.</p>	 <p style="text-align: center;">SEG21                      SEG22</p>
<p>18. Setting Heat mode</p> <p> Press Mode button to be change to HEAT mode in the OFF status.</p>	
<p>19. Setting SEG23, SEG24 mode</p> <p>Press Low Fan button(∨) to enter SEG23 value.</p> <p>Press High Fan button(∧) to enter SEG24 value.</p> <p>Each time you press the button,  →  → ...  →  will be selected in rotation.</p>	 <p style="text-align: center;">SEG23                      SEG24</p>

Check the option you have set

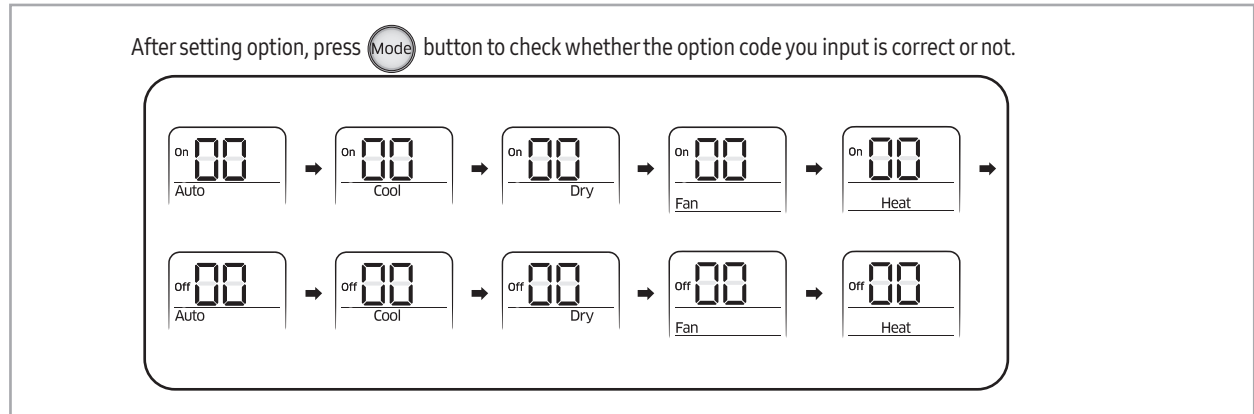

**Step 4** Input option

Press the operation button  with the direction of remote control for set.  
For the correct option setting, you must input the option twice.

**Step 5** Check operation

- 1) Reset the indoor unit by pressing the RESET button of indoor unit or outdoor unit.
- 2) Take the batteries out of the remote controller and insert them again and then press the operation button.

## The procedure of setting option (Cont.)

▶ AR-KH04U remote control (for 360 cassette only)

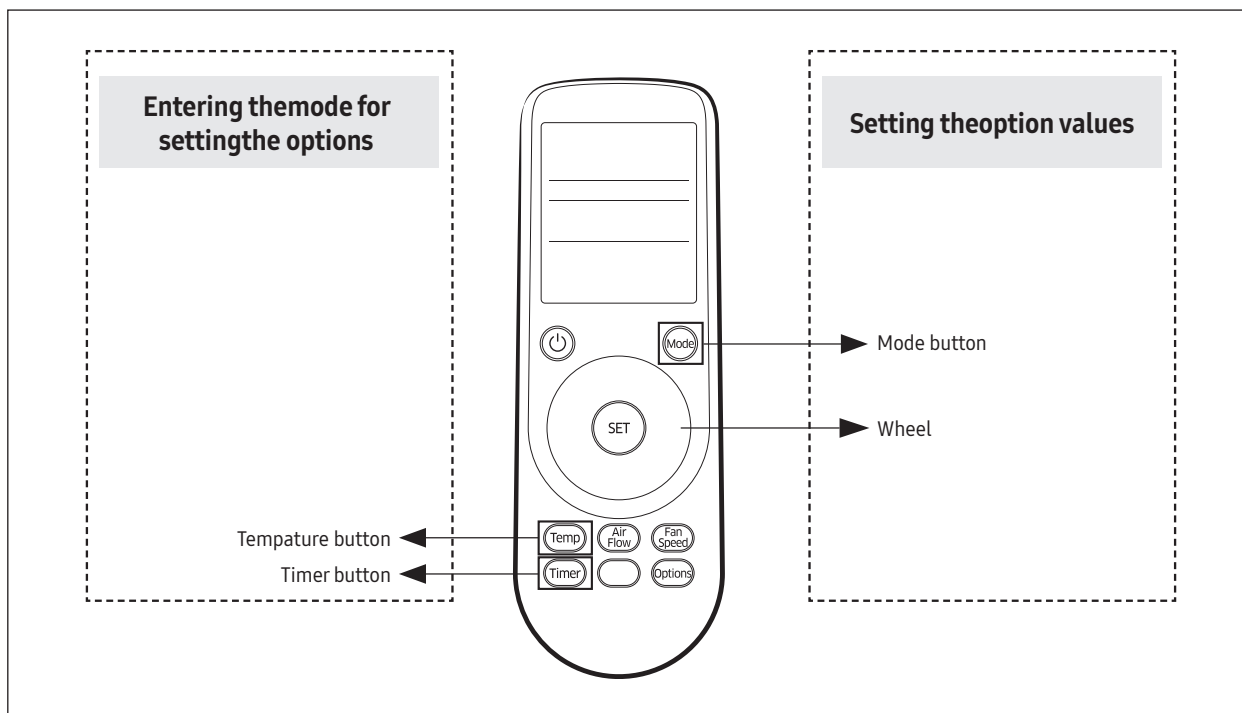

### Step 1 Enter the mode for setting the options

- a. Remove the batteries from the remote control.
- b. While holding down the (Temp) and (Timer) buttons simultaneously, insert the batteries into the remote control.
- c. Make sure that you are entered to the mode for setting the options:

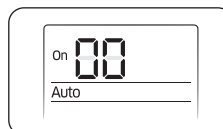















### Step 2 Set the option values.

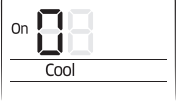
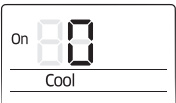

- The total number of available options are 24: SEG1 to SEG24.
- Because SEG1, SEG7, SEG13, and SEG19 are the page options used by the previous remote control models, the modes to set values for these options are skipped automatically.
- Set a 2-digit value for each option pair in the following order :  
 SEG2 and SEG3 → SEG4 and SEG5 → SEG6 and SEG8 → SEG9 and SEG10 → SEG11 and SEG12 → SEG14 and SEG15 → SEG16 and SEG17 → SEG18 and SEG20 → SEG21 and SEG22 → SEG23 and SEG24



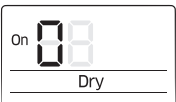
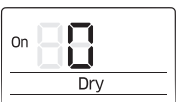

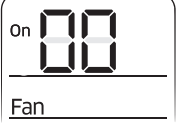





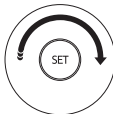

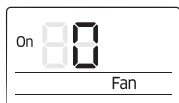

SEG1	SEG2	SEG3	SEG4	SEG5	SEG6	SEG7	SEG8	SEG9	SEG10	SEG11	SEG12	On (SEG1~12)	Off (SEG13~24)
0	X	X	X	X	X	1	X	X	X	X	X		
SEG13	SEG14	SEG15	SEG16	SEG17	SEG18	SEG19	SEG20	SEG21	SEG22	SEG23	SEG24		
2	X	X	X	X	X	3	X	X	X	X	X		

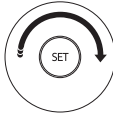
### The procedure of setting option (Cont.)





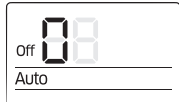
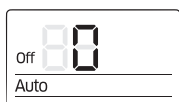

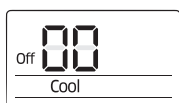



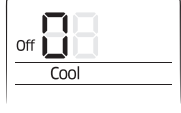
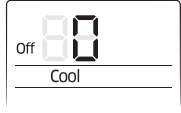

Steps	Remote control display
<p><b>1</b> Set the SEG2 and SEG3 values:</p> <p><b>a</b> Set the SEG2 value by rotating the Wheel counterclockwise until the value you want to set appears on the remote control display.</p>  <p><b>b</b> Set the SEG3 value by rotating the Wheel clockwise until the value you want to set appears on the remote control display.</p>  <p>When you rotate the Wheel, values appear in the following order: 0 → 8 → ... E → F</p>	 <p style="text-align: center;">SEG 2</p>  <p style="text-align: center;">SEG 3</p>
<p><b>2</b> Press the  (Mode) button. <b>Cool</b> and <b>On</b> appear on the remote control display.</p>	
<p><b>3</b> Set the SEG4 and SEG5 values:</p> <p><b>a</b> Set the SEG4 value by rotating the Wheel counterclockwise until the value you want to set appears on the remote control display.</p>  <p><b>b</b> Set the SEG5 value by rotating the Wheel clockwise until the value you want to set appears on the remote control display.</p>  <p>When you rotate the Wheel, values appear in the following order: 0 → 8 → ... E → F</p>	 <p style="text-align: center;">SEG 4</p>  <p style="text-align: center;">SEG 5</p>
<p><b>4</b> Press the  (Mode) button. <b>Dry</b> and <b>On</b> appear on the remote control display.</p>	
<p><b>5</b> Set the SEG6 and SEG8 values:</p> <p><b>a</b> Set the SEG6 value by rotating the Wheel counterclockwise until the value you want to set appears on the remote control display.</p>  <p><b>b</b> Set the SEG8 value by rotating the Wheel clockwise until the value you want to set appears on the remote control display.</p>  <p>When you rotate the Wheel, values appear in the following order: 0 → 8 → ... E → F</p>	 <p style="text-align: center;">SEG 6</p>  <p style="text-align: center;">SEG 8</p>
<p><b>6</b> Press the  (Mode) button. <b>Fan</b> and <b>On</b> appear on the remote control display.</p>	

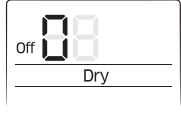
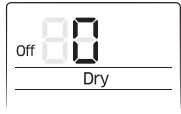

### The procedure of setting option (Cont.)

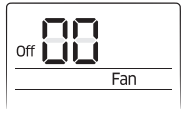
Steps	Remote control display
<p><b>7</b> Set the SEG9 and SEG10 values:</p> <p><b>a</b> Set the SEG9 value by rotating the Wheel counterclockwise until the value you want to set appears on the remote control display.</p>  <p><b>b</b> Set the SEG10 value by rotating the Wheel clockwise until the value you want to set appears on the remote control display.</p>  <p>When you rotate the Wheel, values appear in the following order: 0 → 1 → ... E → F</p>	 <p>SEG 9</p>  <p>SEG 10</p>
<p><b>8</b> Press the  (Mode) button. Heat and On appear on the remote control display.</p>	
<p><b>9</b> Set the SEG11 and SEG12 values:</p> <p><b>a</b> Set the SEG11 value by rotating the Wheel counterclockwise until the value you want to set appears on the remote control display.</p>  <p><b>b</b> Set the SEG12 value by rotating the Wheel clockwise until the value you want to set appears on the remote control display.</p>  <p>When you rotate the Wheel, values appear in the following order: 0 → 1 → ... E → F</p>	 <p>SEG 11</p>  <p>SEG 12</p>
<p><b>10</b> Press the  (Mode) button. Auto and Off appear on the remote control display.</p>	
<p><b>11</b> Set the SEG14 and SEG15 values:</p> <p><b>a</b> Set the SEG14 value by rotating the Wheel counterclockwise until the value you want to set appears on the remote control display.</p>  <p><b>b</b> Set the SEG15 value by rotating the Wheel clockwise until the value you want to set appears on the remote control display.</p>  <p>When you rotate the Wheel, values appear in the following order: 0 → 1 → ... E → F</p>	 <p>SEG 14</p>  <p>SEG 15</p>
<p><b>12</b> Press the  (Mode) button. Cool and Off appear on the remote control display.</p>	

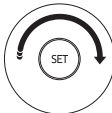
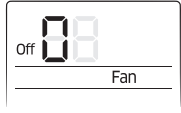
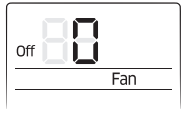
### The procedure of setting option (Cont.)

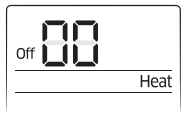
Steps	Remote control display
<p><b>13</b> Set the SEG16 and SEG17 values:</p> <p><b>a</b> Set the SEG16 value by rotating the Wheel counterclockwise until the value you want to set appears on the remote control display.</p>  <p><b>b</b> Set the SEG17 value by rotating the Wheel clockwise until the value you want to set appears on the remote control display.</p>  <p>When you rotate the Wheel, values appear in the following order: 0 → 1 → ... E → F</p>	 <p>SEG16</p>  <p>SEG17</p>
<p><b>14</b> Press the  (Mode) button. Dry and Off appear on the remote control display.</p>	
<p><b>15</b> Set the SEG18 and SEG20 values:</p> <p><b>a</b> Set the SEG18 value by rotating the Wheel counterclockwise until the value you want to set appears on the remote control display.</p>  <p><b>b</b> Set the SEG20 value by rotating the Wheel clockwise until the value you want to set appears on the remote control display.</p>  <p>When you rotate the Wheel, values appear in the following order: 0 → 1 → ... E → F</p>	 <p>SEG18</p>  <p>SEG20</p>
<p><b>16</b> Press the  (Mode) button. Fan and Off appear on the remote control display.</p>	
<p><b>17</b> Set the SEG21 and SEG22 values:</p> <p><b>a</b> Set the SEG21 value by rotating the Wheel counterclockwise until the value you want to set appears on the remote control display.</p>  <p><b>b</b> Set the SEG22 value by rotating the Wheel clockwise until the value you want to set appears on the remote control display.</p>  <p>When you rotate the Wheel, values appear in the following order: 0 → 1 → ... E → F</p>	 <p>SEG21</p>  <p>SEG22</p>
<p><b>18</b> Press the  (Mode) button. Heat and Off appear on the remote control display.</p>	

### The procedure of setting option (Cont.)

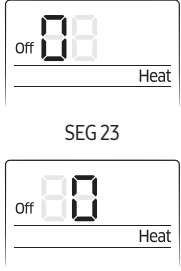
Steps	Remote control display
<p><b>19</b> Set the SEG23 and SEG24 values:</p> <p><b>a</b> Set the SEG23 value by rotating the Wheel counterclockwise until the value you want to set appears on the remote control display.</p> <p><b>b</b> Set the SEG24 value by rotating the Wheel clockwise until the value you want to set appears on the remote control display.</p> <p>When you rotate the Wheel, values appear in the following order: 0 → 1 → ... → E → F</p>	 <p>SEG 23</p> <p>SEG 24</p>

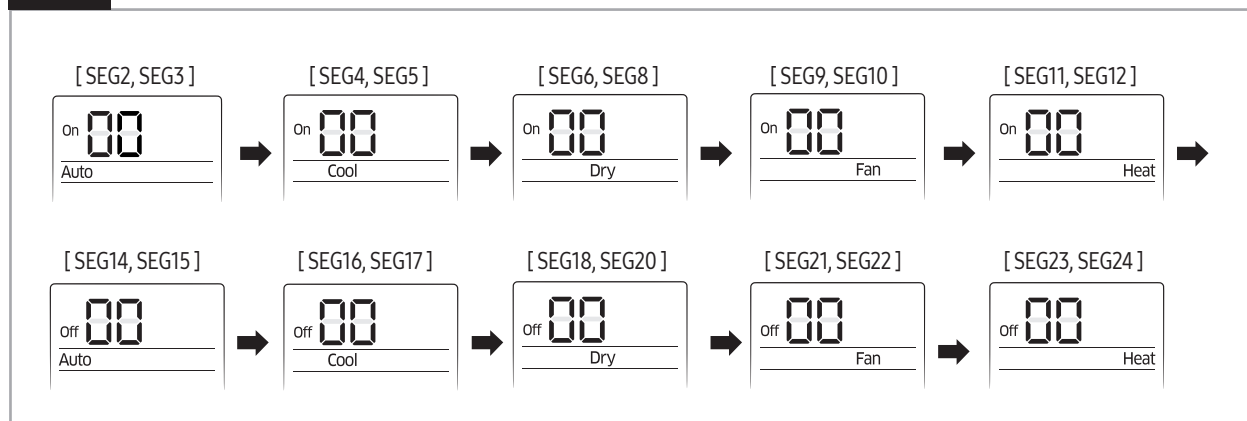

### Step 3 Check whether the option values that you have set are correct by pressing the (Mode) button repeatedly



### Step 4 Save the option values into the indoor unit:

Point the remote control to the remote control sensor on the indoor unit and then press the  (Power) button on the remote control twice. Make sure that this command is received by the indoor unit. When it is successfully received, you can hear a short sound from the indoor unit. If the command is not received, press the  (Power) button again.

### Step 5 Check whether the air conditioner operates in accordance with the option values you have set:

- a** Reset the indoor or outdoor unit.
  - Indoor unit : Press the  (Set) and  (Option) buttons on the remote control simultaneously for 4 seconds.
  - Outdoor unit : Press the K3 button.
- b** Remove the batteries from the remote control, insert them again, and then press the  (Power) button on the remote control.

### 4-1-3. Order for Setting Options (Wired Remote Controller)

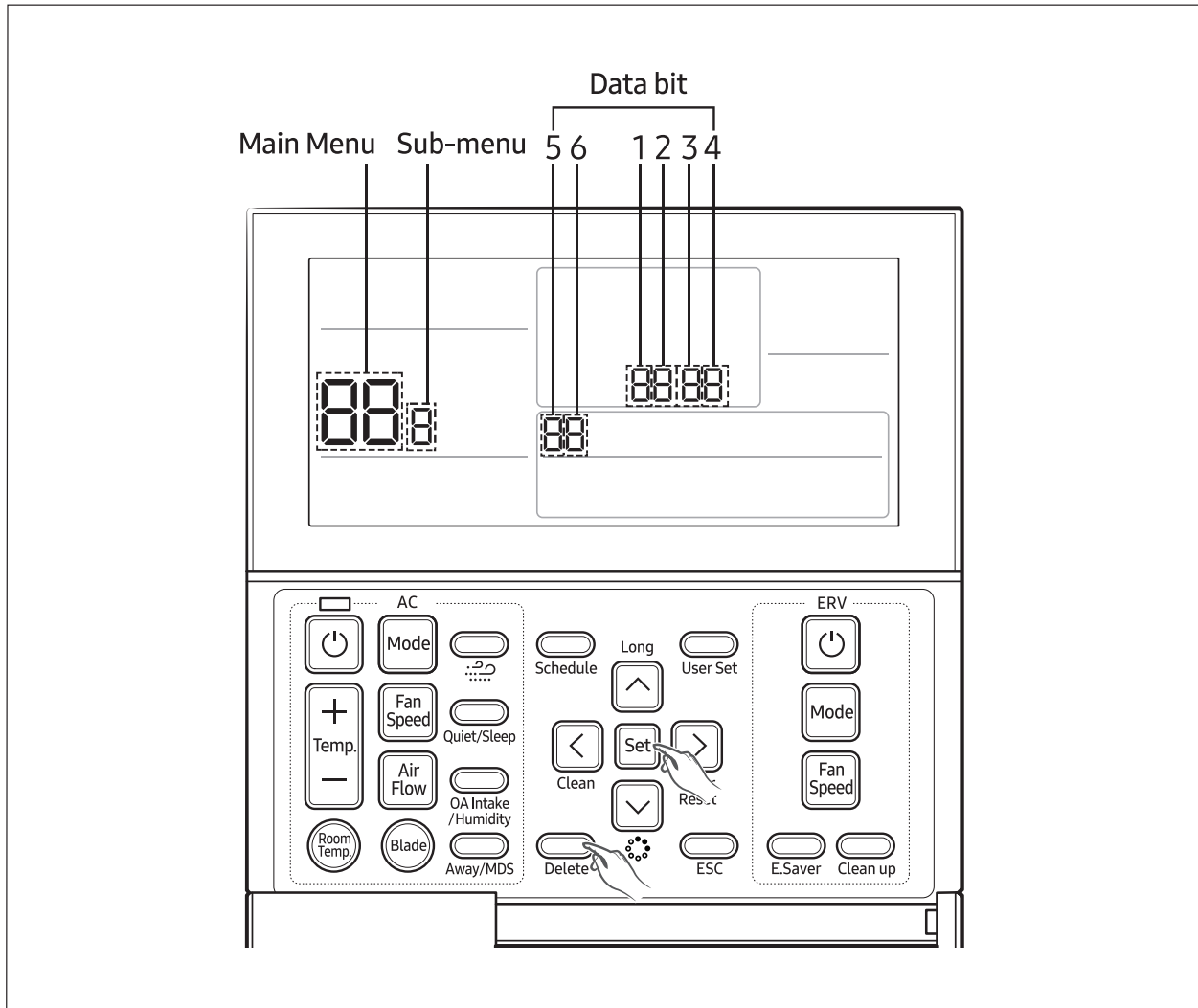

1. If you want to use the various additional functions for your Wired Remote Controller, press the set and delete buttons at the same time for more than three seconds.
  - ▶ You will enter the additional function settings, and the [Main menu] will be displayed.
2. Refer to the list of additional functions for your Wired Remote Controller on the next page, and select the desired menu.
  - ▶ Using the [^]/[v] buttons, select a main menu number and press the [>] button to enter the sub-menu setting screen.
  - ▶ Using the [^]/[v] buttons, select a sub-menu number and press the [>] button to enter data setting screen.
  - ▶ When you enter the setting stage, the current setting will be displayed.
  - ▶ Refer to the chart for data settings.
  - ▶ Using the [^]/[v] buttons, select the settings. Press the [>] button to move to the next setting.
  - ▶ Press the **Set** button to save the settings and exit to the sub-menu setting screen.
  - ▶ Press the **Esc** button to exit to normal mode.



- While setting the data, you can use the [<]/[>] buttons to set the range of Data bit.
- While configuring the setting, press the **Esc** button to exit to the setting sub-menu without saving your changes.

### 4-1-4. Setting the indoor unit addresses

Before installing an indoor unit, be sure to set an address for the indoor unit by taking the following steps:

1. Make sure that the power is supplied to the indoor unit. If the indoor unit is not plugged in, it must include a power supply.
2. Set an address for each indoor unit using the remote control, according to your air conditioning system plan, by referring to the following table and by following the steps in Common steps for setting the addresses and options on page 4-1.
  - The indoor unit addresses (main and RMC addresses) are set to 0A0000-100000-200000-300000 by default.
  - If indoor units and outdoor units match 1:1, you don't need to set the main address because it is automatically set by the outdoor unit.
  - If you are using on or off controller, set RMC address.

Option No. for an indoor unit: 0AXXXX-1XXXXX-2XXXXX-3XXXXX

Option	SEG1		SEG2		SEG3		SEG4		SEG5		SEG6	
Explanation	Page		Mode		Setting main address		100-digit of indoor unit address		10-digit of indoor unit		A single digit of indoor unit	
Indication and details	Indication	Details	Indication	Details	Indication	Details	Indication	Details	Indication	Details	Indication	Details
		0		A		0	No main address	0~9	100-digit	0~9	10-digit	0~9
					1	Main address setting mode						
Option	SEG7		SEG8		SEG9		SEG10		SEG11		SEG12	
Explanation	Page		Reserved		Setting RMC address		Reserved		Group channel(*16)		Group address	
Indication and details	Indication	Details			Indication	Details			Indication	Details	Indication	Details
		1				0	No RMC address			RMC1	1~F	RMC2
					1	RMC address setting mode						



- The main address must be set to a value in the range 0 to 15. If you set other values, communication error will occur.
- If any of SEG5 and SEG6 is set to a value in the range A to F, the main address of the indoor unit does not change.
- If SEG3 is set to 0, the indoor unit maintains the existing main address even if SEG6 is set to a new value.
- If SEG9 is set 0, the indoor unit maintains the existing RMC address even if SEG11 and SET12 are set to new values.

### 4-1-5. Setting an indoor unit installation option (Suitable for the condition of each installation location)

1. Make sure that the power is supplied to the indoor unit.  
If the indoor unit is not plugged in, it must include a power supply.
2. Make sure that the panel is connected to the indoor unit so that it can receive options
3. Set the functional options of indoor units, by referring to the following table and by following the steps in Common steps for setting the addresses and options on page 4-1.
  - The SEG20 option, Individual control with remote control, allows you to control multiple indoor units individually by using the remote control.

■ 1Way CST, 4Way CST : AC\*\*\*BN1DCH, AC\*\*\*BN4DCH

- The installation options of indoor units are set to like a below table by default.

Model	AC009BN1DCH	AC012BN1DCH AC012BN1DCH	AC***BN4DCH
Installation option	020010-100031-200000-300000	020010-100051-200000-300000	020010-100001-200000-300000

Option No. for an indoor unit : 02XXXX-1XXXXX-2XXXXX-3XXXXX

Option	SEG1		SEG2		SEG3	SEG4		SEG5		SEG6		
	Page		Mode			Use of external room temperature sensor / Minimizing fan operation when thermostat is off <sup>1)</sup>		Use of central control		Compensation of the fan RPM		
Function	Indication	Details	Indication	Details	Indication	Details		Indication	Details	Indication	Details	
						Use of external room temperature sensor	Minimizing fan operation when thermostat is off					
Indication and details	0		2		Reserved	0	Disuse	Disuse	0	Disuse	0	Disuse (recessed installation)
						1	Use	Disuse	1	Use	1	RPM compensatio
						2	Disuse	Use(Heating)				
						3	Use	Use(Heating)				
						4	Disuse	Use(Cooling)				
						5	Use	Use(Cooling)				
						6	Disuse	Use (Cooling/Heating)				
						7	Use	Use (Cooling/Heating)				
						8	Disuse	Use (Cooling Ultra low speed)				
						9	Use	Use (Cooling Ultra low speed)				
						A	Disuse	Use (Heating/ Cooling Ultra low speed)				
						B	Use	Use (Heating/ Cooling Ultra low speed)				

**Set the indoor installation options (Option to set for the installation site conditions) (Cont.)**

Option	SEG7		SEG8		SEG9	SEG10	SEG11			SEG12							
Function	Page		Use of drain pump <sup>2)</sup>		Reserved	Reserved	WindFree FAN RPM <sup>3)</sup>			Dew removal operation in WindFree mode/ WindFree mode in Auto cleaning/ Smart Comfort in Auto mode							
Indication and details	Indication	Details	Indication	Details			Details			Indication	Details						
							AC009BN1DCH	AC012BN1DCH AC018BN1DCH	AC***BN4DCH		Dew removal operation in Wind-Free mode	WindFree mode in Auto cleaning	Smart Comfort in Auto mode				
		1		0			Disuse		0	3STEP↑	5STEP↑	Default	0	Maintain blade	Wind-Free disuse	Smart Comfort use	
				1			Use		1	2STEP↑	4STEP↑	1STEP↓	1	Open blade	Wind-Free use		
				2			Use with 3 minute delay		2	1STEP↑	3STEP↑	2STEP↓	2	Maintain blade	Wind-Free use		
										3	Default	2STEP↑	3STEP↓	3	Open blade	Wind-Free disuse	Smart Comfort disuse
										4	1STEP↓	1STEP↑	4STEP↓	4	Maintain blade	Wind-Free disuse	
								5	2STEP↓	Default	5STEP↓	5	Open blade	Wind-Free use			
							6	3STEP↓	1STEP↓	6STEP↓	6	Maintain blade	Wind-Free use				
							7	4STEP↓	2STEP↓	7STEP↓	7	Open blade	Wind-Free use				
Option	SEG13		SEG14		SEG15		SEG16			SEG17		SEG18					
Function	Page		Use of external control		Setting the output of external control		Reserved	Buzzer control		Maximum filter usage time <sup>4)</sup>							
Indication and details	Indication	Details	Indication	Details	Indication	Details		0	Thermo on	0	Use of buzzer	2	1000 hours				
														1	On/Off	Sub, Existing control	
	2	Off	Main, Existing control														
				3	Window	Sub, Reverse control											
	4	Disuse	Main, Reverse control														
				5	On/Off	Main, Reverse control											
	6	Off	Main, Reverse control														
				7	Window	Main, Reverse control											
8	Disuse	Main, Reverse control															
			9	On/Off	Main, Reverse control												
A	Off	Main, Reverse control															
			B	Window	Main, Reverse control												
C	Disuse	Main, Reverse control															
			D	On/Off	Main, Reverse control												
E	Off	Main, Reverse control															
			F	Window	Main, Reverse control												
1	Operation On	6				2000 hours											

Troubleshooting

Option	SEG19		SEG20		SEG21		SEG22	SEG23 <sup>7)</sup>		SEG24	
Function	Page		Individual control with remote control <sup>5)</sup>		Heating setting compensation <sup>6)</sup>		Reserved	Setting the MDS Kit installation option		Reserved	
Indication and details	3	Indication	Details	Indication	Details	Indication		Details	Indication		Details
				0 or 1	Indoor1	0		Default	0		Disuse (Soft Off+Hard off)
				2	Indoor2	1	3.6°F(2°C)	Standard	1	Off after 20 min. (Soft Off+Hard off)	
				3	Indoor3	2	9°F(5°C)		2	Off after 40 min. (Soft Off+Hard off)	
		4	Indoor4	3	Off after 80 min. (Soft Off+Hard off)						
				Premium	4	2	9°F(5°C)	4	Off after 20 min. (Soft Off+Hard off)		
		5	Off after 40 min. (Soft Off+Hard off)								
		6	Off after 80 min. (Soft Off+Hard off)								
		Standard	4	2	9°F(5°C)	7	Off after 20 min. (Soft Off only)				
						8	Off after 40 min. (Soft Off only)				
						9	Off after 80 min. (Soft Off only)				
		Premium	4	2	9°F(5°C)	A	Off after 20 min. (Soft Off only)				
						B	Off after 40 min. (Soft Off only)				
						C	Off after 80 min. (Soft Off only)				

- 1) SEG4  
By SEG4 setting, Minimizing fan operation when thermostat is off.  
– Fan operates for 20 seconds at an interval of 5 minutes in heat mode.  
– Fan stops or operates Ultra low in Cooling when thermostat is off.
- 2) SEG8  
Even if you set the Use of drain pump option to 0, it is automatically set to 2 (the drain pump is used with 3 minute delay).
- 3) SEG11  
Compensation of the WindFree fan RPM option adjusts 20 rpm per 1 step.
- 4) SEG18  
If you set the Maximum filter usage time option to a value other than 2 and 6, it is automatically set to 2 (1000 hours).
- 5) SEG20  
If you set the Individual control with remote control option to a value other than 0 to 4, it is automatically set to 0 (Indoor1)
- 6) SEG21  
Default value of Heating setting compensation is 9°F(5°C).
- 7) SEG23  
**Soft Off:** The indoor unit turns off its operation at the indicated time in the table for Installation Option after its final motion detection. But, it turns on again if the MDS detects motion.  
**Hard Off:** Designated time after SOFT OFF, it cannot turn on automatically when it detects motion. Users should control to turn on the indoor unit with remote control, etc.



■ 4Way CST(600x600) : AC\*\*\*BNNDCH

- The installation options of indoor units are set to 020010-100001-200000-300000 by default.

Option No. for an indoor unit : 02XXXX-1XXXXX-2XXXXX-3XXXXX

Option	SEG1		SEG2		SEG3	SEG4		SEG5		SEG6			
Function	Page		Mode			Use of external room temperature sensor / Minimizing fan operation when thermostat is off		Central control		Compensation of the fan RPM			
Indication and details	Indication	Details	Indication	Details	Reserved	Indication	Details		Indication	Details	Indication	Details	
							Use of external room temperature sensor	Minimizing fan operation when thermostat is off 1)					
	0					0	Disuse	Disuse	0	Disuse	0	Disuse	
	1					1	Use	Disuse					
	2					2	Disuse	Use(Heating)					
	3					3	Use	Use(Heating)					
	4					4	Disuse	Use(Cooling)					
	5					5	Use	Use(Cooling)					
	6					6	Disuse	Use (Cooling/Heating)					
	7					7	Use	Use (Cooling/Heating)					
	8					8	Disuse	Use (Cooling Ultra low speed)	1	Use	1	High ceiling mode	
	9					9	Use	Use (Cooling Ultra low speed)					
A				A	Disuse	Use (Cooling Ultra low speed)							
B				B	Use	Use (Cooling Ultra low speed)							
Option	SEG7		SEG8		SEG9	SEG10	SEG11		SEG12				
Function	Page		Use of drain pump <sup>2)</sup>				Wind-free fan speed <sup>3)</sup>		Dew removal operation in Wind-Free mode/ Wind-Free mode in Auto cleaning/ Smart Comfort in Auto mode				
Indication and details	Indication	Details	Indication	Details	Reserved	Reserved	Indication	Details		Indication	Details		
								Wind-free fan speed <sup>3)</sup>			Dew removal operation in Wind-Free mode	Wind-Free mode in Auto cleaning	Smart Comfort in Auto mode
	0		0	Disuse			0	Default	0	Maintain blade	Wind-Free disuse		
	1		1	Use			1	1Step↓	1	Open blade	Wind-Free disuse		Smart Comfort use
			2				2	2Step↓	2	Maintain blade	Wind-Free use		
			3				3		3	Open blade			
			4				4		4	Maintain blade	Wind-Free disuse		
			2	Use with 3 minute delay			3	3Step↓	5	Open blade	Wind-Free disuse		Smart Comfort disuse
				4	4Step↓	6	Maintain blade	Wind-Free use					
						7	Open blade						

## Troubleshooting

Option	SEG13		SEG14			SEG15		SEG16	SEG17		SEG18		
Function	Page		Use of external control			Setting the output of external control		Reserved	Buzzer control		Maximum filter usage time <sup>4)</sup>		
Indication and details	Indication	Details	Indication	Details		Indication	Details		Indication	Details	Indication	Details	
		2		0	Disuse	Sub, Existing control	0		Thermo on	0	Use of buzzer	2	1000 hours
			1	On/Off									
			2	Off									
			3	Window On/Off									
			4	Disuse									
			5	On/Off									
			6	Off	Main, Existing control	1	Operation On						
			7	Window On/Off									
			8	Disuse									
			9	On/Off	Sub, Reverse control	1	Operation On						
			A	Off									
			B	Window On/Off									
			C	Disuse	Main, Reverse control	1	Operation On						
			D	On/Off									
	E		Off										
	F	Window On/Off											
Option	SEG19		SEG20		SEG21		SEG22	SEG23 <sup>7)</sup>				SEG24	
Function	Page		Individual control with remote control <sup>5)</sup>		Heating setting compensation <sup>6)</sup>		Reserved	Setting the MDS Kit installation option				Reserved	
Indication and details	Indication	Details	Indication	Details	Indication	Details		Indication	Details				
		3		0 or 1	Indoor1	0		Default		0	Disuse (Soft Off+Hard off)		
					2	Indoor2	1	3.6°F(2°C)	Standard	1	Off after 20 min. (Soft Off+Hard off)		
										2	Off after 40 min. (Soft Off+Hard off)		
										3	Off after 80 min. (Soft Off+Hard off)		
					3	Indoor3	2	9°F(5°C)	Premium	4	Off after 20 min. (Soft Off+Hard off)		
										5	Off after 40 min. (Soft Off+Hard off)		
										6	Off after 80 min. (Soft Off+Hard off)		
					4	Indoor4	2	9°F(5°C)	Standard	7	Off after 20 min. (Soft Off only)		
										8	Off after 40 min. (Soft Off only)		
										9	Off after 80 min. (Soft Off only)		
					4	Indoor4	2	9°F(5°C)	Premium	A	Off after 20 min. (Soft Off only)		
										B	Off after 40 min. (Soft Off only)		
										C	Off after 80 min. (Soft Off only)		

• 1) SEG4

- By SEG4 setting, Minimizing fan operation when thermostat is off.
- Fan operates for 20 seconds at an interval of 5 minutes in heat mode.
- Fan stops or operates Ultra low in Cooling when thermostat is off.

• 2) SEG8

Even if you set the Use of drain pump option to 0, it is automatically set to 2 (the drain pump is used with 3 minute delay).

• 3) SEG11

Compensation of the wind-free fan RPM option adjusts 20 rpm per 1 step.

• 4) SEG18

If you set the Maximum filter usage time option to a value other than 2 and 6, it is automatically set to 2 (1000 hours).

• 5) SEG20

If you set the Individual control with remote control option to a value other than 0 to 4, it is automatically set to 0 (Indoor1)

• 6) SEG21

Default value of Heating setting compensation is 9°F(5°C).

• 7) SEG23

**Soft Off:** The indoor unit turns off its operation at the indicated time in the table for Installation Option after its final motion detection. But, it turns on again if the MDS detects motion.

**Hard Off:** Designated time after SOFT OFF, it cannot turn on automatically when it detects motion. Users should control to turn on the indoor unit with remote control, etc.

■ 360 CST : AC\*\*\*BN6DCH

- The installation options of indoor units are set to 020010-100000-200000-300000 by default.

Option No. for an indoor unit : 02XXXX-1XXXXX-2XXXXX-3XXXXX

Option	SEG1		SEG2		SEG3	SEG4		SEG5		SEG6			
Function	Page		Mode			Use of external room temperature sensor / Minimizing fan operation when thermostat is off <sup>1)</sup>		Central control		Compensation of the fan RPM			
Indication and details	Indication	Details	Indication	Details	Reserved	Indication	Details		Indication	Details	Indication	Details	
							Use of external room temperature sensor	Minimizing fan operation when thermostat is off					
	0			0			0	Disuse	Disuse	0	Disuse	0	Disuse (Recessed installation)
							1	Use	Disuse				
							2	Disuse	Use(Heating)				
							3	Use	Use(Heating)			1	High-ceiling mode (Recessed installation)
							4	Disuse	Use(Cooling)				
							5	Use	Use(Cooling)				
							6	Disuse	Use (Cooling/Heating)			4	Disuse (Exposed installation)
							7	Use	Use (Cooling/Heating)				
							8	Disuse	Use (Cooling Ultra low speed)	1	Use		
							9	Use	Use (Cooling Ultra low speed)			5	High-ceiling mode (Exposed installation)
							A	Disuse	Use (Cooling Ultra low speed)				
					B	Use	Use (Cooling Ultra low speed)						
Option	SEG7		SEG8		SEG9	SEG10	SEG11	SEG12					
Function	Page		Use of drain pump <sup>2)</sup>		Reserved	Reserved	Reserved	Reserved					
Indication and details	Indication	Details	Indication	Details									
									1	0	Disuse		
						1	Use						
			2	Use with 3 minute delay									
Option	SEG13		SEG14		SEG15	SEG16	SEG17	SEG18					
Function	Page		Use of external control		Setting the output of external control		Buzzer control		Maximum filter usage time <sup>3)</sup>				
Indication and details	Indication	Details	Indication	Details	Indication	Details	Indication	Details	Indication	Details			
											0 <td>Disuse</td> <td rowspan="2">0</td> <td rowspan="2">Thermo on</td> <td rowspan="2">0</td> <td rowspan="2">Use of buzzer</td> <td rowspan="2">2</td> <td rowspan="2">1000 hours</td>	Disuse	0
	1	On/Off	Sub, Existing control										
	2	Off		Main, Existing control									
	3	Window On/Off	0		Thermo on	Reserved	0	Use of buzzer	2	1000 hours			
	4	Disuse											
	5	On/Off	Main, Existing control										
	6	Off											
	7	Window On/Off	0	Thermo on	Reserved	0	Use of buzzer	2	1000 hours				
	8	Disuse											
	9	On/Off	Sub, Reverse control										
	A	Off											
	B	Window On/Off	1	Operation On	Reserved	1	Disuse of buzzer	6	2000 hours				
	C	Disuse											
	D	On/Off	Main, Reverse control										
E	Off												
F	Window On/Off												

## Troubleshooting

Option	SEG 19		SEG 20		SEG 21		SEG 22	SEG 23		SEG 24					
Function	Page		Individual control with remote control <sup>4)</sup>		Heating setting compensation <sup>5)</sup>		Reserved	Setting the MDS Kit installation option <sup>6)</sup>		Cycle time of swing					
Indication and details	Indication	Details	Indication	Details	Indication	Details		Indication	Details	Indication	Details				
	3			0, 1	Indoor 1	0	Default	Reserved	0	Disuse (Soft Off+Hard off)	0	34 seconds (default)			
									Standard	1			Off after 20 min. (Soft Off+Hard off)		
										2			Off after 40 min. (Soft Off+Hard off)		
				3	Off after 80 min. (Soft Off+Hard off)										
				Premium	4	Off after 20 min. (Soft Off+Hard off)									
					5	Off after 40 min. (Soft Off+Hard off)									
					6	Off after 80 min. (Soft Off+Hard off)									
				Standard	7	Off after 20 min. (Soft Off only)	2		9°F (5°C)	2	9°F (5°C)	7	Off after 20 min. (Soft Off only)	1	30 seconds
					Standard	8						Off after 40 min. (Soft Off only)			
9						Off after 80 min. (Soft Off only)									
Premium	A	Off after 20 min. (Soft Off only)	2	9°F (5°C)	2	9°F (5°C)	A	Off after 20 min. (Soft Off only)	2	38 seconds					
	Premium	B					Off after 40 min. (Soft Off only)								
		C					Off after 80 min. (Soft Off only)								

- 1) SEG4

- By SEG4 setting, Minimizing fan operation when thermostat is off.
- Fan operates for 20 seconds at an interval of 5 minutes in heat mode.
  - Fan stops or operates Ultra low in Cooling when thermostat is off.

- 2) SEG8

Even if you set the Use of drain pump option to 0, it is automatically set to 2 (the drain pump is used with 3 minute delay).

- 3) SEG18

If you set the Maximum filter usage time option to a value other than 2 and 6, it is automatically set to 2 (1000 hours).

- 4) SEG20

If you set the Individual control with remote control option to a value other than 0 to 4, it is automatically set to 0 (Indoor1)

- 5) SEG21

Default value of Heating setting compensation is 9°F. (5°C).

- 6) SEG23

**Soft Off:** The indoor unit turns off its operation at the indicated time in the table for Installation Option after its final motion detection. But, it turns on again if the MDS detects motion.

**Hard Off:** Designated time after SOFT OFF, it cannot turn on automatically when it detects motion. Users should control to turn on the indoor unit with remote control, etc.

■ Home Duct, Duct S : AC\*\*\*BNLDCH, AC\*\*\*BNHDCH

- The installation options of indoor units are set to 020010-120000-200000-300000 by default.

Option No. for an indoor unit : 0AXXXX-1XXXXX-2XXXXX-3XXXXX

Option	SEG1		SEG2		SEG3			SEG4		
Explanation	PAGE		MODE		RESERVED			Use of external temperature sensor		
Indication and Details	Indication	Details	Indication	Details				Indication	Details	
	0		2					0	Disuse	
								1	Use	
Option	SEG5		SEG6		SEG7		SEG8			
Explanation	Use of central control		RESERVED		Indication	Details	Use of drain pump <sup>1)</sup>			
Indication and Details	Indication	Details			1	Indication	Details			
	0	Disuse				0	Disuse			
	1	Use				1	Use			
				2	Use + 3minute delay					
Option	SEG9		SEG10		SEG11			SEG12		
Explanation	Use of Hot Coil		Use of auxiliary heater		Controller variables for auxiliary heater			RESERVED		
Indication and Details	Indication	Details	Indication	Details	Indication	Details				
	0	Disuse	0	Disuse		Set temperature for auxiliary heat on	Time delay for auxiliary heat on			
						0	No temperature offset			No delay
						1	No temperature offset			10 minutes
					2	No temperature offset	20 minutes			
	1	Use	1	Use	3	2.7°F(1.5°C)	No delay			
					4	2.7°F(1.5°C)	10 minutes			
					5	2.7°F(1.5°C)	20 minutes			
					6	5.4°F(3°C)	No delay			
					7	5.4°F(3°C)	10 minutes			
					8	5.4°F(3°C)	20 minutes			
	-		2	Use (Heater time delay)	9	8.1°F(4.5°C)	No delay			
					A	8.1°F(4.5°C)	10 minutes			
					B	8.1°F(4.5°C)	20 minutes			
					C	10.8°F(6°C)	No delay			
D					10.8°F(6°C)	10 minutes				
E					10.8°F(6°C)	20 minutes				

Troubleshooting

Option	SEG13		SEG14			SEG15		SEG16		
Explanation	PAGE		Use of external control			Setting the output of external control		RESERVED		
Indication and Details	Indication	Details	Indication	Details		Indication	Details			
	2			0	Disuse	Sub, Existing Control	0			Thermo on
				1	On/Off					
				2	Off					
				3	Window					
				4	Disuse	Main, Existing Control				
				5	On/Off					
				6	Off					
				7	Window					
				8	Disuse	Sub, Reverse Control	1	Operation on		
				9	On/Off					
				A	Off					
				B	Window					
				C	Disuse	Main, Reverse Control				
				D	On/Off					
E				Off						
F	Window									
Option	SEG17		SEG18			SEG19		SEG20		
Explanation	Buzzer control		Maximum filter usage time <sup>2)</sup>			PAGE		Individual control with remote control <sup>3)</sup>		
Indication and Details	Indication	Details	Indication	Details		Indication	Details	Indication	Details	
	0	Use of buzzer	2	1000 Hour				3	0 or 1	Indoor1
	1	Disuse	6	2000 Hour					2	Indoor2
									3	Indoor3
4						Indoor4				
Option	SEG21		SEG22		SEG23		SEG24			
Explanation	Heating setting compensation <sup>4)</sup>		RESERVED		Away Set OFF Timer		RESERVED			
Indication and Details	Indication	Details			Indication	Details				
	0	Disuse			0 or 1	Auto Set OFF 30Min.				
	1	3.6°F(2°C)			2	Auto Set OFF 60Min.				
	2	9°F(5°C)			3	Auto Set OFF 120Min.				
4			Auto Set OFF 180Min.							

- 1) SEG4  
By SEG4 setting, Minimizing fan operation when thermostat is off.  
- Fan operates for 20 seconds at an interval of 5 minutes in heat mode.  
- Fan stops or operates Ultra low in Cooling when thermostat is off.
- 2) SEG18  
If you set the Maximum filter usage time option to a value other than 2 and 6, it is automatically set to 2 (1000 hours).
- 3) SEG20  
If you set the Individual control with remote control option to a value other than 0 to 4, it is automatically set to 0 (Indoor1)
- 4) SEG21  
Default value of Heating setting compensation is 3.6°F(2°C).

■ Console : AC\*\*\*BNJDCH

- The installation options of indoor units are set to 020010-100000-200000-300000 by default.

Option No. for an indoor unit : 02XXXX-1XXXXX-2XXXXX-3XXXXX

Option	SEG1		SEG2		SEG3	SEG4			SEG5		SEG6						
Function	Page		Mode		Reserved	Use of external room temperature sensor / Minimizing fan operation when thermostat is off 1)			Central control		Reserved						
Indication and details	Indication	Details	Indication	Details		0	1	Indication	Details			0	Disuse				
									Use of external room temperature sensor					Minimizing fan operation when thermostat is off 1)			
									Disuse					Disuse			
									Use					Disuse			
									Disuse					Use(Heating)			
									Use					Use(Heating)			
									Disuse					Use(Cooling)			
									Use					Use(Cooling)			
									Disuse					Use (Cooling/Heating)"			
									Use					Use (Cooling/Heating)"			
									Disuse					Use (Cooling Ultra low speed)			
									Use					Use (Cooling Ultra low speed)			
					Disuse				Use (Heating/Cooling Ultra low speed)								
				Use		Use (Heating/Cooling Ultra low speed)											
Option	SEG7		SEG8		SEG9	SEG10		SEG11		SEG12							
Function	Page		Use of drain pump		Reserved	Reserved		Reserved		Reserved							
Indication and details	Indication	Details	Indication	Details													
	1		0	Disuse													
			8	Use external drain pump													

## Troubleshooting

Option	SEG13		SEG14			SEG15		SEG16	SEG17		SEG18							
Function	Page		Use of external control			Setting the output of external control		Reserved	Buzzer control		Maximum filter usage time 4)							
Indication and details	Indication	Details	Indication	Details		Indication	Details		Indication	Details	Indication	Details						
	2			0	Disuse	Sub, Existing control	0		Thermo on	0	Use of buzzer	2	1000 hours					
				1	On/Off													
				2	Off													
				3	Window On/Off													
				4	Disuse	Main, Existing control												
				5	On/Off													
				6	Off													
				7	Window On/Off													
				8	Disuse	Sub, Reverse control		1						Operation On	1	Disuse of buzzer	6	2000 hours
				9	On/Off													
				A	Off													
				B	Window On/Off													
				C	Disuse	Main, Reverse control												
				D	On/Off													
E				Off														
F	Window On/Off																	
Option	SEG19		SEG20			SEG21			SEG22	SEG23		SEG24						
Function	Page		Individual control with remote control 5)			Heating setting compensation 4)			Reserved	Reserved	Reserved							
Indication and details	Indication	Details	Indication	Details		Indication	Details											
	3			0 or 1	Indoor1	0	Default											
				2	Indoor2	1	3.6 °F(2 °C)											
				3	Indoor3	2	9 °F(5 °C)											
4				Indoor4														

- 1) SEG4  
By SEG4 setting, Minimizing fan operation when thermostat is off.  
- Fan operates for 20 seconds at an interval of 5 minutes in heat mode.  
- Fan stops or operates Ultra low in Cooling when thermostat is off.
- 2) SEG18  
If you set the Maximum filter usage time option to a value other than 2 and 6, it is automatically set to 2 (1000 hours).
- 3) SEG20  
If you set the Individual control with remote control option to a value other than 0 to 4, it is automatically set to 0 (Indoor1)
- 4) SEG21  
Default value of Heating setting compensation is 9°F(5°C).



■ RAC (Windfree) : AC\*\*\*BNADCH

- The installation options of indoor units are set to like a below table by default.

Model	AC018BNADCH	AC024BNADCH
Installation option	020010-100011-200000-300000	020010-100041-200000-300000

Option No. for an indoor unit : 02XXXX-1XXXXX-2XXXXX-3XXXXX

Option	SEG1		SEG2		SEG3	SEG4			SEG5		SEG6				
Function	Page		Mode		Reserved	Use of external room temperature sensor / Minimizing fan operation when thermostat is off <sup>1)</sup>			Central control		Reserved				
Indication and details	Indication	Details	Indication	Details		Indication	Details		Indication	Details					
	0			2				0				Disuse	Disuse	0	Disuse
						1			Use	Disuse					
						2			Disuse	Use(Heating)					
						3			Use	Use(Heating)					
						4			Disuse	Use(Cooling)					
						5			Use	Use(Cooling)					
						6			Disuse	Use (Cooling/Heating)"					
						7			Use	Use (Cooling/Heating)"					
						8			Disuse	Use (Cooling Ultra low speed)					
						9			Use	Use (Cooling Ultra low speed)					
						A			Disuse	Use (Heating/Cooling Ultra low speed)					
					B	Use			Use (Heating/Cooling Ultra low speed)						
1					1	Use		Use							

Option	SEG7		SEG8		SEG9	SEG10	SEG11		SEG12									
Function	Page		Use of drain pump		Reserved	Reserved	Wind-free fan speed <sup>2)</sup>		Dew removal operation in Wind-Free mode/ Wind-Free mode in Auto cleaning/ Smart Comfort in Auto mode									
Indication and details	Indication	Details	Indication	Details			Indication	Details		Indication	Details							
	1			0				Disuse	0		1Step↑	4Step↑	0	Maintain blade	Wind-Free mode in Auto cleaning	Smart Comfort in Auto mode		
							1			Default				3Step↑	1		Open blade	Wind-Free disuse
							2			1Step↓				2Step↑	2		Maintain blade	Wind-Free use
							3			2Step↓				1Step↑	3		Open blade	
							4			3Step↓				Default	4		Maintain blade	Wind-Free disuse
							5			4Step↓				1Step↓	5		Open blade	
							6			5Step↓				2Step↓	6		Maintain blade	Wind-Free use
								7	Open blade									
				8			Use external drain pump											

## Troubleshooting

Option	SEG13		SEG14			SEG15		SEG16	SEG17		SEG18	
Function	Page		Use of external control			Setting the output of external control		Reserved	Buzzer control		Maximum filter usage time <sup>3)</sup>	
Indication and details	Indication	Details	Indication	Details		Indication	Details		Indication	Details	Indication	Details
		2		0	Disuse	Sub, Existing control	0		Thermo on	0	Use of buzzer	2
	1		On/Off									
	2		Off									
	3		Window On/Off									
	4		Disuse	Main, Existing control								
	5		On/Off									
	6		Off									
	7		Window On/Off									
	8		Disuse	Sub, Reverse control	1	Operation On	1	Disuse of buzzer	6	2000 hours		
	9		On/Off									
	A		Off									
	B		Window On/Off									
	C		Disuse	Main, Reverse control								
	D		On/Off									
	E		Off									
	F		Window On/Off									
Option	SEG19		SEG20			SEG21		SEG22	SEG23		SEG24	
Function	Page		Individual control with remote control <sup>5)</sup>			Heating setting compensation <sup>4)</sup>		Reserved	Reserved		Reserved	
Indication and details	Indication	Details	Indication	Details		Indication	Details					
		3	0 or 1	Indoor1		0	Default					
			2	Indoor2		1	3.6°F(2°C)					
			3	Indoor3		2	9°F(5°C)					
	4		Indoor4									

• 1) SEG4: By SEG4 setting, Minimizing fan operation when thermostat is off.

- Fan operates for 20 seconds at an interval of 5 minutes in heat mode.

- Fan stops or operates Ultra low in Cooling when thermostat is off.

• 2) SEG11: Compensation of the wind-free fan RPM option adjusts 20 rpm per 1 step.

• 3) SEG18: If you set the Maximum filter usage time option to a value other than 2 and 6, it is automatically set to 2 (1000 hours).

• 4) SEG20: If you set the Individual control with remote control option to a value other than 0 to 4, it is automatically set to 0 (Indoor1)

• 5) SEG21: Default value of Heating setting compensation is 9°F(5°C).

■ RAC (MAX4) : AC\*\*\*BNTDCH

- The installation options of indoor units are set to 020010-100000-200000-300000 by default.

Option No. for an indoor unit : 02XXXX-1XXXXX-2XXXXX-3XXXXX

Option	SEG1		SEG2		SEG3	SEG4			SEG5		SEG6							
Function	Page		Mode		Reserved	Use of external room temperature sensor / Minimizing fan operation when thermostat is off <sup>1)</sup>			Central control		Reserved							
Indication and details	Indication	Details	Indication	Details		0	2	Indication	Details			0	Disuse					
									Use of external room temperature sensor					Minimizing fan operation when thermostat is off		1	Use	
									0	Disuse				Disuse				
									1	Use				Disuse				
									2	Disuse				Use(Heating)				
									3	Use				Use(Heating)				
									4	Disuse				Use(Cooling)				
									5	Use				Use(Cooling)				
									6	Disuse				Use (Cooling/Heating)				
									7	Use				Use (Cooling/Heating)				
									8	Disuse				Use (Cooling Ultra low speed)				
									9	Use				Use (Cooling Ultra low speed)				
					A				Disuse	Use (Heating/Cooling Ultra low speed)								
				B	Use	Use (Heating/Cooling Ultra low speed)												
Option	SEG7		SEG8		SEG9	SEG10		SEG11	SEG12									
Function	Page		Use of drain pump		Reserved	Reserved		Reserved	Reserved									
Indication and details	Indication	Details	Indication	Details														
	1		0	Disuse														
			8	Use external drain pump														

## Troubleshooting

Option	SEG13		SEG14			SEG15		SEG16	SEG17		SEG18	
Function	Page		Use of external control			Setting the output of external control		Reserved	Buzzer control		Maximum filter usage time <sup>2)</sup>	
Indication and details	Indication	Details	Indication	Details		Indication	Details		Indication	Details	Indication	Details
		2		0	Disuse	Sub, Existing control	0		Thermo on	0	Use of buzzer	2
	1		On/Off									
	2		Off									
	3		Window On/Off									
	4		Disuse	Main, Existing control								
	5		On/Off									
	6		Off									
	7		Window On/Off									
	8		Disuse	Sub, Reverse control	1	Operation On	1	Disuse of buzzer	6	2000 hours		
	9		On/Off									
	A		Off									
	B		Window On/Off									
	C		Disuse	Main, Reverse control								
	D		On/Off									
	E		Off									
	F		Window On/Off									
Option	SEG19		SEG20			SEG21		SEG22	SEG23		SEG24	
Function	Page		Individual control with remote control <sup>3)</sup>			Heating setting compensation <sup>4)</sup>		Reserved	Reserved	Reserved		
Indication and details	Indication	Details	Indication	Details		Indication	Details					
		3	0 or 1	Indoor1		0	Default					
			2	Indoor2		1	3.6°F(2°C)					
			3	Indoor3		2	9°F(5°C)					
	4		Indoor4									

- 1) SEG4: By SEG4 setting, Minimizing fan operation when thermostat is off.  
 - Fan operates for 20 seconds at an interval of 5 minutes in heat mode.  
 - Fan stops or operates Ultra low in Cooling when thermostat is off.
- 2) SEG18: If you set the Maximum filter usage time option to a value other than 2 and 6, it is automatically set to 2 (1000 hours).
- 3) SEG20: If you set the Individual control with remote control option to a value other than 0 to 4, it is automatically set to 0 (Indoor1)
- 4) SEG21: Default value of Heating setting compensation is 9°F(5°C).

■ MPAH : AC\*\*\*BNZDCH

- The installation options of indoor units are set to 020010-100000-200000-300000 by default.

Option No. for an indoor unit : 02XXXX-1XXXXX-2XXXXX-3XXXXX

Option	SEG1		SEG2		SEG3	SEG4		SEG5		
Function	Page		Mode		Reserved	Use of external room temperature sensor / Minimizing fan operation when thermostat is off <sup>1)</sup>		Central control		
Indication and details	Indication	Details	Indication	Details		Indication	Details		Indication	Details
	0		2			0	Use of external room temperature sensor	Minimizing fan operation when thermostat is off	0	Disuse
					1	Disuse	Disuse			
				2	Use	Disuse				
				3	Disuse	Use(Heating)				
				4	Use	Use(Heating)				
				5	Disuse	Use(Cooling)				
				6	Use	Use(Cooling)				
				7	Disuse	Use (Cooling/Heating)				
				8	Use	Use (Cooling/Heating)				
				9	Disuse	Use (Cooling Ultra low speed)				
				A	Use	Use (Cooling Ultra low speed)				
				B	Disuse	Use (Heating/Cooling Ultra low speed)				
					Use	Use (Heating/Cooling Ultra low speed)	1	Use		

Troubleshooting

Option	SEG7		SEG8		SEG9		SEG10		SEG11			SEG12
Function	Page		Use of drain pump		Use of Hot Coil		Use of Hot auxiliary heater		Controller variables for auxiliary heater			Reserved
Indication and details	Indication	Details	Indication	Details	Indication	Details	Indication	Details	Indication	Details		
	1		0	Disuse	0	Disuse	0	Disuse		Set temperature for auxiliary heat on	Time delay for auxiliary heat on	
									0	No temperature offset	No delay	
1	No temperature offset	10 minutes										
2	No temperature offset	20 minutes										
3	2.7°F(1.5°C)	No delay										
4	2.7°F(1.5°C)	10 minutes										
5	2.7°F(1.5°C)	20 minutes										
6	5.4°F(3°C)	No delay										
7	5.4°F(3°C)	10 minutes										
8	5.4°F(3°C)	20 minutes										
9	8.1°F(4.5°C)	No delay										
A	8.1°F(4.5°C)	10 minutes										
B	8.1°F(4.5°C)	20 minutes										
C	10.8°F(6°C)	No delay										
D	10.8°F(6°C)	10 minutes										
E	10.8°F(6°C)	20 minutes										

Option	SEG13		SEG14			SEG15		SEG16	SEG17		SEG18
Function	Page		Use of external control			Setting the output of external control		Reserved	Buzzer control		Reserved
Indication and details	Indication	Details	Indication	Details		Indication	Details		Indication	Details	
		2		0	Disuse	Sub, Existing control	0		Thermo on	0	
			1	On/Off							
			2	Off							
			3	Window On/Off							
			4	Disuse	Main, Existing control						
			5	On/Off							
			6	Off							
			7	Window On/Off							
			8	Disuse	Sub, Reverse control	1	Operation On	1	Disuse of buzzer		
			9	On/Off							
			A	Off							
			B	Window On/Off	Main, Reverse control						
			C	Disuse							
			D	On/Off							
			E	Off							
			F	Window On/Off							
Option	SEG19		SEG20		SEG21		SEG22	SEG23		SEG24	
Function	Page		Individual control with remote control <sup>2)</sup>		Heating setting compensation <sup>3)</sup>		Reserved	Reserved	Reserved		
Indication and details	Indication	Details	Indication	Details	Indication	Details					
		3	0,1	Indoor1	0	Default					
			2	Indoor2	1	3.6°F(2°C)					
			3	Indoor3							
	4		Indoor4	2	9°F(5°C)						

- 1) SEG4  
By SEG4 setting, Minimizing fan operation when thermostat is off.  
- Fan operates for 20 seconds at an interval of 5 minutes in heat mode.  
- Fan stops or operates Ultra low in Cooling when thermostat is off.
- 2) SEG20  
If you set the Individual control with remote control option to a value other than 0 to 4, it is automatically set to 0 (Indoor1)
- 3) SEG21  
Default value of Heating setting compensation is 3.6°F(2°C).

Troubleshooting

■ MPAH : AC\*\*\*KNZDCH

- The installation options of indoor units are set to 020010-100000-200000-300000 by default.

Option No. for an indoor unit : 02XXXX-1XXXXX-2XXXXX-3XXXXX

Option	SEG1		SEG2		SEG3		SEG4		SEG5			SEG6			
Function	Page		Mode		Reserved		Use of external temperature sensor		Central control			Reserved			
Indication and details	Indication	Details	Indication	Details			Indication	Details	Indication	Details					
	0		2				0	Disuse	0	Disuse					
Option	SEG7		SEG8		SEG9		SEG10		SEG11			SEG12			
Function	Page		Use of drain pump		Use of Hot Coil		Use of Hot auxiliary heater		Controller variables for auxiliary heater				Reserved		
Indication and details	Indication	Details	Indication	Details	Indication	Details	Indication	Details	Indication	Details					
	1		0	Disuse	0	Disuse	0	Disuse		Set temperature for auxiliary heat on	Time delay for auxiliary heat on				
									0	No temperature offset	No delay				
									1	No temperature offset	10 minutes				
									2	No temperature offset	20 minutes				
			3	2.7°F(1.5°C)	No delay										
			4	2.7°F(1.5°C)	10 minutes										
			5	2.7°F(1.5°C)	20 minutes										
			6	5.4°F(3°C)	No delay										
			7	5.4°F(3°C)	10 minutes										
8			5.4°F(3°C)	20 minutes											
9	8.1°F(4.5°C)	No delay													
A	8.1°F(4.5°C)	10 minutes													
B	8.1°F(4.5°C)	20 minutes													
C	10.8°F(6°C)	No delay													
D	10.8°F(6°C)	10 minutes													
E	10.8°F(6°C)	20 minutes													



Option	SEG13		SEG14		SEG15		SEG16	SEG17		SEG18
Function	Page		Use of external control		Setting the output of external control		Reserved	Buzzer control		Reserved
Indication and details	Indication	Details	Indication	Details	Indication	Details		Indication	Details	
	2		0	Disuse	0	Thermo on		0	Use of buzzer	
			1	On/Off	1	Operation On		1	Disuse of buzzer	
			2	Off						
3	Window On/Off									
Option	SEG19		SEG20		SEG21		SEG22	SEG23		SEG24
Function	Page		Individual control with remote control <sup>1)</sup>		Heating setting compensation <sup>2)</sup>		Reserved	Reserved		Reserved
Indication and details	Indication	Details	Indication	Details	Indication	Details				
	3		0,1	Indoor1	0	Default				
			2	Indoor2	1	3.6°F(2°C)				
			3	Indoor3						
4			Indoor4	2	9°F(5°C)					

- 1) SEG20  
If you set the Individual control with remote control option to a value other than 0 to 4, it is automatically set to 0 (Indoor1)
- 2) SEG21  
Default value of Heating setting compensation is 3.6°F(2°C).

### 4-1-6. Changing the addresses and options individually

When you want to change the value of a specific option, refer to the following table and follow the steps in Common steps for setting the addresses and options

Option	SEG1		SEG2		SEG3		SEG4		SEG5		SEG6	
Function	Page		Mode		Type of the option to change		Tens position of the option number		Units position of the option number		New value	
Indication and details	Indication	Details	Indication	Details	Indication	Details	Indication	Details	Indication	Details	Indication	Details
		0		D		Option type	0 to F	Tens position value	0 to 9	Units position value	0 to 9e	New value

Example: Changing the Buzzer control (SEG17) option of the functional options to 1 disuse.

Option	SEG1		SEG2		SEG3		SEG4		SEG5		SEG6	
Function	Page		Mode		Type of the option to change		Tens position of the option number		Units position of the option number		New value	
Indication	0		D		2		1		7		1	

### 4-1-7. Emergency Temperature Output (ETO) function



- In order to deploy the ETO function, the MIM-B14, an external contact interface module, must be installed in each indoor unit.
- The ETO is a concept of emergency operation of indoor units. If the indoor unit 1 (main indoor unit) stops because of an error, the indoor unit 2 (sub indoor unit) starts to operate.
- Basically, the indoor unit 2 operates in the previous mode. [For the first time operation, it starts in 24 °C Auto mode.]
- To set more detailed operation conditions for the indoor unit 2, use the S-net Pro.

#### ■ Setting up the ETO

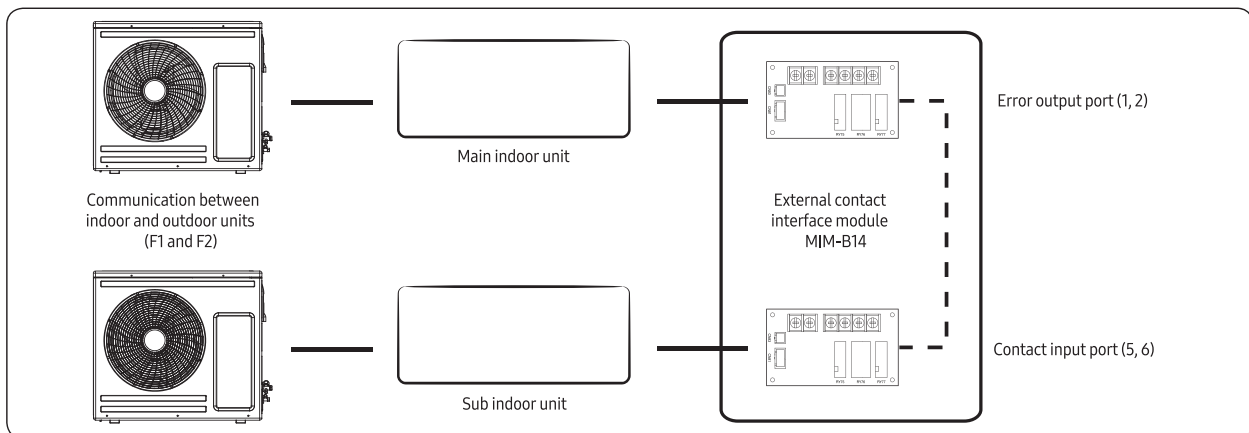

#### 1 Main indoor unit

- Disable the external contact control (Default).
- Connect the S-net pro2 to F1 and F2.
- Enable the ETO function and set the temperature and time.

#### 2 Sub indoor unit

- (Required) Enable the external contact control (with the installation option SEG14 - Reverse Control).
- Connect the S-net pro2 to F1 and F2.
- Enable the entrance control and set the mode, set temperature, and fan speed.

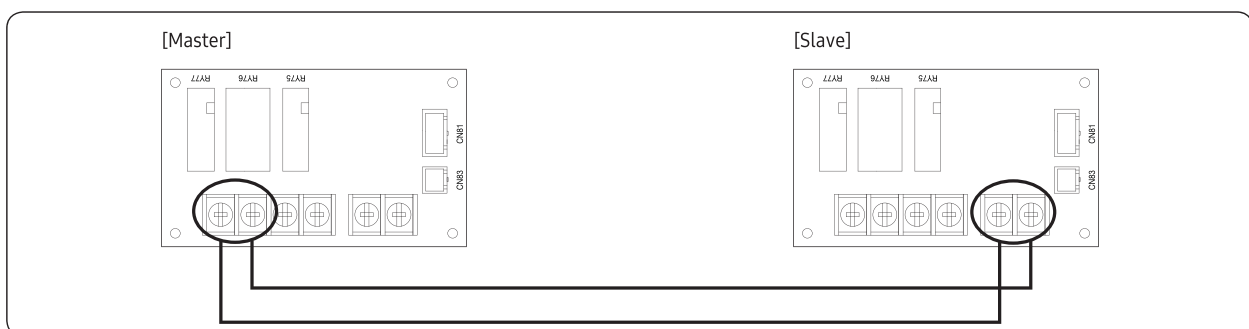

## Emergency Temperature Output (ETO) function (Cont.)

### ■ ETO operation specifications

#### 1 Main indoor unit

- Based on the external contact control settings, the main indoor unit decides whether to generate output when an error (indoor unit stop) occurs.
- Based on the ETO settings, the main indoor unit decides whether to generate output according to the temperature and time conditions.

#### 2 Sub indoor unit

- Based on the entrance control settings, the sub indoor unit decides the mode, set temperature, and fan speed when contact inputs are given.

	Enable of ETO	Enable of external contact	Error port output
Main indoor unit	X	X	N/A
	X	O	Output due to an error
	O	X	Output by ETO entrance conditions (temperature / time / error occurrence)
	O	O	Output by ETO entrance conditions (temperature / time / error occurrence) * Ready to control the main contact input

	Enable of entrance control	Enable of external contact	Operation when outputting Main
Sub indoor unit	X	X	N/A
	X	O	On with the previous operation conditions
	O	O	On with the entrance control enabled

## 4-2. Model-specific option code

Item	Model	SEG												Static Pressure (mmAq)
		1	2	3	4	5	6	7	8	9	10	11	12	
1way Cassette	AC009BN1DCH	0	1	7	3	F	C	1	9	3	0	F	8	
	AC012BN1DCH	0	1	7	3	F	C	1	9	3	4	4	D	
	AC018BN1DCH	0	1	8	3	F	C	1	9	3	4	2	C	
4way Cassette	AC018BN4DCH	0	1	4	3	F	F	1	9	5	0	C	6	
	AC024BN4DCH	0	1	4	3	F	F	1	9	5	0	C	6	
	AC030BN4DCH	0	1	4	3	F	F	1	9	5	4	1	8	
	AC036BN4DCH	0	1	4	3	F	F	1	9	5	4	6	A	
	AC042BN4DCH	0	1	4	3	F	F	1	9	5	4	7	B	
	AC048BN4DCH	0	1	4	3	F	F	1	9	5	4	8	C	
4way Cassette (600x600)	AC009BNNDCH	0	1	5	3	F	F	1	9	1	0	C	8	
	AC012BNNDCH	0	1	5	3	F	F	1	9	3	0	F	9	
	AC018BNNDCH	0	1	5	3	F	F	1	9	3	4	5	D	
360 Cassette	AC018BN6DCH	0	1	0	3	F	F	1	9	5	0	D	8	
	AC024BN6DCH	0	1	0	3	F	F	1	9	5	0	D	8	
	AC030BN6DCH	0	1	0	3	F	F	1	9	5	4	1	A	
	AC036BN6DCH	0	1	1	3	F	F	1	9	5	4	8	C	
	AC042BN6DCH	0	1	1	3	F	F	1	9	5	4	9	D	
	AC048BN6DCH	0	1	1	3	F	F	1	9	5	4	A	F	
Home duct	AC009BNLDCH	0	1	C	3	F	C	1	C	5	4	0	7	0.3≤P≤1.5
		0	1	C	3	F	C	1	C	5	4	6	B	1.5<P≤2.6
		0	1	C	3	F	C	1	C	5	5	C	0	2.6<P≤4.0
		0	1	C	3	F	C	1	C	5	9	0	3	4.0<P≤5.0
		0	1	C	3	F	C	1	C	5	9	4	5	5.0<P≤6.0
	AC012BNLDCH	0	1	C	3	F	C	1	C	5	4	B	C	0.3≤P≤1.5
		0	1	C	3	F	C	1	C	5	5	F	0	1.5<P≤2.6
		0	1	C	3	F	C	1	C	5	9	4	4	2.6<P≤4.0
		0	1	C	3	F	C	1	C	5	9	8	6	4.0<P≤5.0
		0	1	C	3	F	C	1	C	5	9	B	9	5.0<P≤6.0
	AC018BNLDCH	0	1	C	3	F	C	1	C	5	4	F	B	0.3≤P≤1.5
		0	1	C	3	F	C	1	C	5	8	3	D	1.5<P≤2.6
		0	1	C	3	F	C	1	C	5	9	8	0	2.6<P≤4.0
		0	1	C	3	F	C	1	C	5	9	B	2	4.0<P≤5.0
		0	1	C	3	F	C	1	C	5	9	F	5	5.0<P≤6.0
Duct S	AC009BNHDCH	0	1	B	3	F	C	1	C	5	0	D	3	2.5≤P≤5
		0	1	B	3	F	C	1	C	5	4	6	6	5<P≤7.5
		0	1	B	3	F	C	1	C	5	4	D	9	7.5<P≤10
		0	1	B	3	F	C	1	C	5	8	2	C	10<P≤12.5
		0	1	B	3	F	C	1	C	5	9	7	0	12.5<P≤15

Item	Model	SEG												Static Pressure (mmAq)
		13	14	15	16	17	18	19	20	21	22	23	24	
1way Cassette	AC009BN1DCH	2	7	1	A	2	3	3	7	1	1	2	0	
	AC012BN1DCH	2	7	2	3	2	8	3	7	1	1	2	0	
	AC018BN1DCH	2	A	3	4	3	B	3	7	2	5	6	0	
4way Cassette	AC018BN4DCH	2	F	3	4	3	B	3	7	0	0	2	0	
	AC024BN4DCH	2	7	4	8	4	F	3	7	0	0	2	0	
	AC030BN4DCH	2	7	5	A	5	E	3	7	0	0	4	0	
	AC036BN4DCH	2	7	6	9	7	5	3	7	0	0	4	0	
	AC042BN4DCH	2	7	7	D	8	A	3	7	0	0	4	0	
	AC048BN4DCH	2	7	8	C	9	B	3	7	0	0	4	0	
4way Cassette (600x600)	AC009BNNDCH	2	7	1	A	2	3	3	7	0	0	4	0	
	AC012BNNDCH	2	7	2	3	2	8	3	7	0	0	0	0	
	AC018BNNDCH	2	5	3	4	3	B	3	7	0	0	0	0	
360 Cassette	AC018BN6DCH	2	A	3	4	3	B	3	7	0	0	0	0	
	AC024BN6DCH	2	7	4	8	4	F	3	7	0	0	4	0	
	AC030BN6DCH	2	7	5	A	5	E	3	7	0	0	4	0	
	AC036BN6DCH	2	7	6	9	7	5	3	7	0	0	4	0	
	AC042BN6DCH	2	7	7	D	8	A	3	7	0	0	4	0	
	AC048BN6DCH	2	7	8	C	9	B	3	7	0	0	4	0	
Home duct	AC009BNLDCH	2	7	1	A	2	3	3	7	0	0	0	0	0.3≤P≤1.5
		2	7	1	A	2	3	3	7	0	0	0	0	1.5<P≤2.6
		2	7	1	A	2	3	3	7	0	0	0	0	2.6<P≤4.0
		2	7	1	A	2	3	3	7	0	0	0	0	4.0<P≤5.0
		2	7	1	A	2	3	3	7	0	0	0	0	5.0<P≤6.0
	AC012BNLDCH	2	7	2	3	2	8	3	7	0	0	0	0	0.3≤P≤1.5
		2	7	2	3	2	8	3	7	0	0	0	0	1.5<P≤2.6
		2	7	2	3	2	8	3	7	0	0	0	0	2.6<P≤4.0
		2	7	2	3	2	8	3	7	0	0	0	0	4.0<P≤5.0
		2	7	2	3	2	8	3	7	0	0	0	0	5.0<P≤6.0
	AC018BNLDCH	2	3	3	4	3	C	3	7	0	0	0	0	0.3≤P≤1.5
		2	3	3	4	3	C	3	7	0	0	0	0	1.5<P≤2.6
		2	3	3	4	3	C	3	7	0	0	0	0	2.6<P≤4.0
		2	3	3	4	3	C	3	7	0	0	0	0	4.0<P≤5.0
		2	3	3	4	3	C	3	7	0	0	0	0	5.0<P≤6.0
Duct S	AC009BNHDCH	2	7	1	A	2	3	3	7	0	0	0	0	2.5≤P≤5
		2	7	1	A	2	3	3	7	0	0	0	0	5<P≤7.5
		2	7	1	A	2	3	3	7	0	0	0	0	7.5<P≤10
		2	7	1	A	2	3	3	7	0	0	0	0	10<P≤12.5
		2	7	1	A	2	3	3	7	0	0	0	0	12.5<P≤15

Item	Model	SEG												Static Pressure (mmAq)
		1	2	3	4	5	6	7	8	9	10	11	12	
Duct S	AC012BNHDCH	0	1	B	3	F	C	1	C	5	4	0	4	2.5≤P≤5
		0	1	B	3	F	C	1	C	5	4	7	7	5<P≤7.5
		0	1	B	3	F	C	1	C	5	4	E	A	7.5<P≤10
		0	1	B	3	F	C	1	C	5	8	3	D	10<P≤12.5
		0	1	B	3	F	C	1	C	5	9	8	1	12.5<P≤15
	AC018BNHDCH	0	1	B	3	F	C	1	C	5	4	1	6	2.5≤P≤5
		0	1	B	3	F	C	1	C	5	4	7	A	5<P≤7.5
		0	1	B	3	F	C	1	C	5	4	D	F	7.5<P≤10
		0	1	B	3	F	C	1	C	5	9	3	3	10<P≤12.5
		0	1	B	3	F	C	1	C	5	9	9	7	12.5<P≤15
		0	1	B	3	F	C	1	C	5	9	F	B	15<P≤17.5
		0	1	B	3	F	C	1	C	5	E	5	0	17.5<P≤20
	AC024BNHDCH	0	1	B	3	F	C	1	C	5	4	2	A	2.5≤P≤5
		0	1	B	3	F	C	1	C	5	4	8	E	5<P≤7.5
		0	1	B	3	F	C	1	C	5	5	E	1	7.5<P≤10
		0	1	B	3	F	C	1	C	5	9	3	5	10<P≤12.5
		0	1	B	3	F	C	1	C	5	9	9	8	12.5<P≤15
		0	1	B	3	F	C	1	C	5	9	F	C	15<P≤17.5
		0	1	B	3	F	C	1	C	5	D	5	F	17.5<P≤20
	AC030BNHDCH	0	1	B	3	F	C	1	C	5	4	7	B	2.5≤P≤5
		0	1	B	3	F	C	1	C	5	4	D	E	5<P≤7.5
		0	1	B	3	F	C	1	C	5	9	2	2	7.5<P≤10
		0	1	B	3	F	C	1	C	5	9	6	7	10<P≤12.5
		0	1	B	3	F	C	1	C	5	9	B	9	12.5<P≤15
		0	1	B	3	F	C	1	C	5	9	F	C	15<P≤17.5
		0	1	B	3	F	C	1	C	5	D	3	E	17.5<P≤20
	AC036BNHDCH	0	1	B	3	F	C	1	C	5	4	3	9	2.5≤P≤5
		0	1	B	3	F	C	1	C	5	4	8	C	5<P≤7.5
		0	1	B	3	F	C	1	C	5	4	C	E	7.5<P≤10
		0	1	B	3	F	C	1	C	5	5	F	1	10<P≤12.5
		0	1	B	3	F	C	1	C	5	9	3	3	12.5<P≤15
		0	1	B	3	F	C	1	C	5	9	6	5	15<P≤17.5
0		1	B	3	F	C	1	C	5	9	A	6	17.5<P≤20	

Item	Model	SEG												Static Pressure (mmAq)
		13	14	15	16	17	18	19	20	21	22	23	24	
Duct S	AC012BNHDCH	2	7	2	3	2	8	3	7	0	0	0	0	2.5≤P≤5
		2	7	2	3	2	8	3	7	0	0	0	0	5<P≤7.5
		2	7	2	3	2	8	3	7	0	0	0	0	7.5<P≤10
		2	7	2	3	2	8	3	7	0	0	0	0	10<P≤12.5
		2	7	2	3	2	8	3	7	0	0	0	0	12.5<P≤15
	AC018BNHDCH	2	F	3	4	3	C	3	7	0	0	2	0	2.5≤P≤5
		2	F	3	4	3	C	3	7	0	0	2	0	5<P≤7.5
		2	F	3	4	3	C	3	7	0	0	2	0	7.5<P≤10
		2	F	3	4	3	C	3	7	0	0	2	0	10<P≤12.5
		2	F	3	4	3	C	3	7	0	0	2	0	12.5<P≤15
		2	F	3	4	3	C	3	7	0	0	2	0	15<P≤17.5
		2	F	3	4	3	C	3	7	0	0	2	0	17.5<P≤20
	AC024BNHDCH	2	7	4	8	4	F	3	7	0	0	2	0	2.5≤P≤5
		2	7	4	8	4	F	3	7	0	0	2	0	5<P≤7.5
		2	7	4	8	4	F	3	7	0	0	2	0	7.5<P≤10
		2	7	4	8	4	F	3	7	0	0	2	0	10<P≤12.5
		2	7	4	8	4	F	3	7	0	0	2	0	12.5<P≤15
		2	7	4	8	4	F	3	7	0	0	2	0	15<P≤17.5
		2	7	4	8	4	F	3	7	0	0	2	0	17.5<P≤20
	AC030BNHDCH	2	7	5	A	5	E	3	7	0	0	2	0	2.5≤P≤5
		2	7	5	A	5	E	3	7	0	0	2	0	5<P≤7.5
		2	7	5	A	5	E	3	7	0	0	2	0	7.5<P≤10
		2	7	5	A	5	E	3	7	0	0	2	0	10<P≤12.5
		2	7	5	A	5	E	3	7	0	0	2	0	12.5<P≤15
		2	7	5	A	5	E	3	7	0	0	2	0	15<P≤17.5
		2	7	5	A	5	E	3	7	0	0	2	0	17.5<P≤20
	AC036BNHDCH	2	7	6	9	7	5	3	7	0	0	4	5	2.5≤P≤5
		2	7	6	9	7	5	3	7	0	0	4	5	5<P≤7.5
		2	7	6	9	7	5	3	7	0	0	4	5	7.5<P≤10
		2	7	6	9	7	5	3	7	0	0	4	5	10<P≤12.5
		2	7	6	9	7	5	3	7	0	0	4	5	12.5<P≤15
		2	7	6	9	7	5	3	7	0	0	4	5	15<P≤17.5
2		7	6	9	7	5	3	7	0	0	4	5	17.5<P≤20	



Item	Model	SEG												Static Pressure (mmAq)
		1	2	3	4	5	6	7	8	9	10	11	12	
Duct S	AC042BNHDCH	0	1	B	3	F	C	1	C	5	4	4	9	2.5≤P≤5
		0	1	B	3	F	C	1	C	5	4	9	C	5<P≤7.5
		0	1	B	3	F	C	1	C	5	4	D	E	7.5<P≤10
		0	1	B	3	F	C	1	C	5	9	0	1	10<P≤12.5
		0	1	B	3	F	C	1	C	5	9	4	3	12.5<P≤15
		0	1	B	3	F	C	1	C	5	9	7	5	15<P≤17.5
		0	1	B	3	F	C	1	C	5	9	B	6	17.5<P≤20
	AC048BNHDCH	0	1	B	3	F	C	1	C	5	4	5	A	2.5≤P≤5
		0	1	B	3	F	C	1	C	5	4	A	D	5<P≤7.5
		0	1	B	3	F	C	1	C	5	4	E	F	7.5<P≤10
		0	1	B	3	F	C	1	C	5	9	1	2	10<P≤12.5
		0	1	B	3	F	C	1	C	5	9	5	4	12.5<P≤15
		0	1	B	3	F	C	1	C	5	9	8	6	15<P≤17.5
		0	1	B	3	F	C	1	C	5	9	C	7	17.5<P≤20
Console	AC009BNJDCH	0	1	9	3	F	F	1	9	3	0	B	6	
	AC012BNJDCH	0	1	9	3	F	F	1	9	3	0	D	8	
	AC018BNJDCH	0	1	9	3	F	F	1	9	2	4	0	A	
CRAC	AC018BNADCH	0	1	1	2	F	F	1	9	5	4	2	B	
	AC024BNADCH	0	1	1	2	F	F	1	9	3	4	5	E	
	AC030BNTDCH	0	1	1	3	F	F	1	9	3	5	7	2	
	AC036BNTDCH	0	1	1	3	F	F	1	9	4	5	9	3	
MPAH	AC018BNZDCH	0	1	E	2	F	C	1	0	5	0	2	0	
	AC024BNZDCH	0	1	E	2	F	C	1	0	5	0	2	0	
	AC030BNZDCH	0	1	E	2	F	C	1	0	5	0	2	0	
	AC036BNZDCH	0	1	E	2	F	C	1	0	5	0	2	0	
	AC042BNZDCH	0	1	E	2	F	C	1	0	5	0	2	0	
	AC048BNZDCH	0	1	E	2	F	C	1	0	5	0	2	0	
	AC018KNZDCH	0	1	E	0	6	C	1	0	5	0	2	0	
	AC024KNZDCH	0	1	E	0	6	C	1	0	5	0	2	0	
	AC030KNZDCH	0	1	E	0	6	C	1	0	5	0	2	0	
	AC036KNZDCH	0	1	E	0	6	C	1	0	5	0	2	0	
	AC042KNZDCH	0	1	E	0	6	C	1	0	5	0	2	0	
AC048KNZDCH	0	1	E	0	6	C	1	0	5	0	2	0		

Item	Model	SEG												Static Pressure (mmAq)
		13	14	15	16	17	18	19	20	21	22	23	24	
Duct S	AC042BNHDCH	2	7	7	D	8	A	3	7	0	0	4	5	2.5≤P≤5
		2	7	7	D	8	A	3	7	0	0	4	5	5<P≤7.5
		2	7	7	D	8	A	3	7	0	0	4	5	7.5<P≤10
		2	7	7	D	8	A	3	7	0	0	4	5	10<P≤12.5
		2	7	7	D	8	A	3	7	0	0	4	5	12.5<P≤15
		2	7	7	D	8	A	3	7	0	0	4	5	15<P≤17.5
		2	7	7	D	8	A	3	7	0	0	4	5	17.5<P≤20
	AC048BNHDCH	2	7	8	C	9	B	3	7	0	0	4	5	2.5≤P≤5
		2	7	8	C	9	B	3	7	0	0	4	5	5<P≤7.5
		2	7	8	C	9	B	3	7	0	0	4	5	7.5<P≤10
		2	7	8	C	9	B	3	7	0	0	4	5	10<P≤12.5
		2	7	8	C	9	B	3	7	0	0	4	5	12.5<P≤15
		2	7	8	C	9	B	3	7	0	0	4	5	15<P≤17.5
		2	7	8	C	9	B	3	7	0	0	4	5	17.5<P≤20
Console	AC009BNJDCH	2	7	1	A	2	3	3	7	0	4	0	0	
	AC012BNJDCH	2	7	2	3	2	8	3	7	0	5	0	0	
	AC018BNJDCH	2	0	3	4	3	A	3	7	0	4	0	8	
CRAC	AC018BNADCH	2	A	3	4	3	B	3	7	1	4	4	0	
	AC024BNADCH	2	7	4	8	4	F	3	7	1	5	4	0	
	AC030BNTDCH	2	7	5	A	5	E	3	7	1	7	0	0	
	AC036BNTDCH	2	7	6	9	7	5	3	7	1	7	0	0	
MPAH	AC018BNZDCH	2	F	3	4	3	C	3	7	0	0	0	0	
	AC024BNZDCH	2	7	4	8	4	F	3	7	0	0	0	0	
	AC030BNZDCH	2	7	5	A	5	E	3	7	0	0	0	0	
	AC036BNZDCH	2	7	6	9	7	5	3	7	0	0	0	5	
	AC042BNZDCH	2	7	7	D	8	9	3	7	0	0	0	D	
	AC048BNZDCH	2	7	8	C	9	B	3	7	0	0	0	D	
	AC018KNZDCH	2	7	3	4	3	B	3	7	0	0	0	5	
	AC024KNZDCH	2	7	4	7	5	0	3	7	0	0	0	5	
	AC030KNZDCH	2	7	5	A	6	4	3	7	0	0	0	5	
	AC036KNZDCH	2	7	6	4	7	0	3	7	0	0	0	5	
	AC042KNZDCH	2	7	7	D	8	C	3	7	0	0	0	5	
AC048KNZDCH	2	7	8	C	A	0	3	7	0	0	0	5		

## 4-3. Diagnostic Checklist

### 4-3-1. Test operation mode and check mode

#### ■ Display Options key

Key	Push type	Mode	Display				
			SEG1	SEG2	SEG3	SEG4	
K1	Short	1st	Heating test mode	H	1	8	8
		2nd	Defrost test mode <sup>1)</sup>	H	3	8	8
		3rd	End Key operation	8	8	8	8
K2	Short	1st	Cooling test mode	H	2	8	8
		2nd	Inverter check	H	4	8	8
		3rd	Pump down	H	6	8	8
		4th	Not Used/No Function	H	8	8	8
		5th	Inverter Fault Detection (Comp#1) <sup>2)</sup>	H	A	8	8
		6th	Auto trial operation	H	E	8	8
		7th	Auto check <sup>3)</sup> (Installation commissioning mode)	H	E	8	8
8th	End Key operation	8	8	8	8		
K3	Short	1st	Reset Release Eco mode	8	8	8	8

1) Defrost test mode

Condition 1: The outdoor temperature is below 10°C.

Condition 2: All the temperature conditions should meet the defrost conditions.

2) Indication on the display and action to take when an inverter fault is detected

	SEG1	SEG2	SEG3	SEG4	Action to take
Fault detection is in progress	8	8	8	8	-
OK	8	8	0	H	-
NG	8	8	A	0	PBA defect: Replace the PBA
Check	8	8	E	H	Manual inspection is required
Going into fault detection mode failed	8	8	F	L	Try fault detection again

3) Auto check (Installation commissioning mode)

To ensure normal operation of the product, first make sure to complete auto check. .

※ AC\*\*BXSCC series are not allowed to proceed K1 key test operation mode due to cooling only models.

<AC024/030/036/042/048BXADCH, AC030/036BXSCC, AC030/036BXSCCH>



<AC009/012/018BXADCH, AC018/024BXSCC>

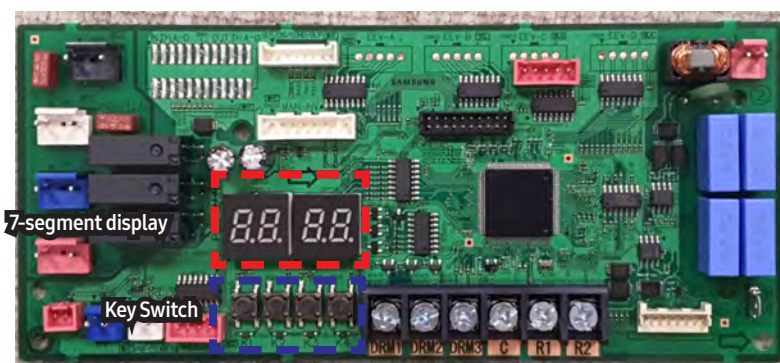

## Test operation mode and check mode (Cont.)

### ■ View Mode

K4 short push	Display contents	SEG1	SEG2	SEG3	SEG4	Unit
1	Order frequency	1	Hundreds digit	Tens digit	Units digit	Hz
2	Current frequency	2	Hundreds digit	Tens digit	Units digit	Hz
3	The number of preset indoor units	3	Hundreds digit	Tens digit	Units digit	EA
4	Ambient temperature sensor	4	Hundreds digit or - <sup>1)</sup>	Tens digit	Units digit	°C or °F <sup>2)</sup>
5	Compressor discharge sensor	5	Hundreds digit	Tens digit	Units digit	°C or °F <sup>2)</sup>
6	Eva-Mid sensor	6	Hundreds digit or - <sup>1)</sup>	Tens digit	Units digit	°C or °F <sup>2)</sup>
7	Condensor sensor	7	Hundreds digit or - <sup>1)</sup>	Tens digit	Units digit	°C or °F <sup>2)</sup>
8	Current	8	Tens digit	Units digit	The first place of decimals	A
9	Outdoor fan RPM	9	Thousands digit	Hundreds digit	Tens digit	rpm
10	Target discharge temperature	A	Hundreds digit or - <sup>1)</sup>	Tens digit	Units digit	°C or °F <sup>2)</sup>
11	EEV	B	Hundreds digit	Tens digit	Units digit	step
12	The capacity sum of indoor units	C	Tens digit	Unit digit	The first place of decimals	kW or kBtu/h <sup>3)</sup>
13	Protective control	D	0: Cooling 1: Heating	Protective control 0: No Protective control 1: Freezing 2: Non-stop defrosting 3: Over-load 4: Discharge 5: Total electric current	Frequency status 0: Normal 1: Hold 2: Down 3: Up_limit 4: Down_limit	-
14	IPM temperature	E	Hundreds digit or - <sup>1)</sup>	Tens digit	Units digit	°C or °F <sup>2)</sup>
15	The number of connected indoor units	F	Hundreds digit	Tens digit	Units digit	EA
16	ESC EEV(CAM)	G	Hundreds digit	Tens digit	Units digit	step
17	ESC IN sensor	H	Hundreds digit or - <sup>1)</sup>	Tens digit	Units digit	°C or °F <sup>2)</sup>
18	ESC OUT sensor	I	Hundreds digit or - <sup>1)</sup>	Tens digit	Units digit	°C or °F <sup>2)</sup>
19	View mode end	BLANK	BLANK	BLANK	BLANK	

1) Sub-zero temperatures are expressed as a minus, instead of hundreds digit.

2) The temperature unit can be switched between Celsius and Fahrenheit through Setting outdoor unit option switches. (Default value is Celsius.)

3) If the temperature unit is set to Fahrenheit through Setting outdoor unit option switches, the value is expressed in the unit of kBtu/h.

## Test operation mode and check mode (Cont.)

### ■ Version Check & Address Check

		Display contents	SEG1	SEG2	SEG3	SEG4
K4 long push	-	Main micom version	Year (Dec)	Month (Hex)	Date (Tens digit)	Date (Units digit)
	After short push 1	Inverter micom version	Year (Dec)	Month (Hex)	Date (Tens digit)	Date (Units digit)
	After short push 2	E2P version	Year (Dec)	Month (Hex)	Date (Tens digit)	Date (Units digit)
	After short push 3	Page 1 - AUTO Page 2 - (SEG1,2 - Indoor : "A","0") (SEG3,4 - Address : ex)00 )				
	After short push 4	Page 1 - MANU Page 2 - (SEG1,2 - Indoor : "A","0") (SEG3,4 - Address : ex)00 )				

- Long push K4(Main micom ver.) → short push 1 more (Inv. micom ver.) → short push 1 more (E2P. ver.) → short push 1 more (Automatic address) → short push 1 more (Manual address) → short push 1 more (Main micom ver.) → ..... → Long push K4(veiw mode end)

## Test operation mode and check mode (Cont.)

### ■ Setting outdoor unit option switch and address manually

#### ▶ Setting the option

- Press and hold K2 to enter the option setting. (Only available when the operation is stopped)
  - If you enter the option setting, display will show the following.

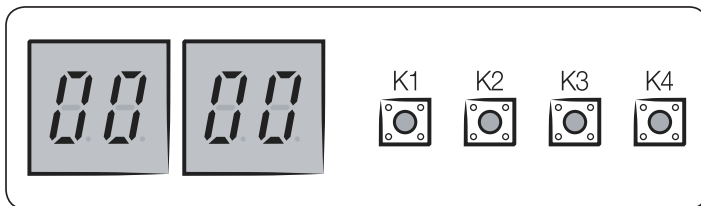

- Seg 1 and Seg 2 will display the number for selected option.
- Seg 3 and Seg 4 will display the number for set value of the selected option.
- If you have selected desired option, you can shortly press the K2 switch to adjust the value of the Seg 3, Seg 4 and change the function for the selected option

#### Example)

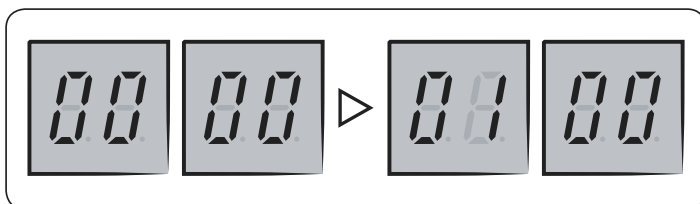

- If you have selected desired option, you can shortly press the K2 switch to adjust the value of the Seg 3, Seg 4 and change the function for the selected option.

#### Example)

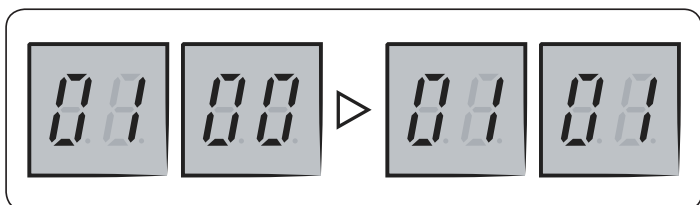

- After selecting the function for options, press and hold the K2 switch for 2 seconds. Edited value of the option will be saved when entire segments blinks and tracking mode begins.

Option item	Input unit	SEG1	SEG2	SEG3	SEG4	Function
Channel address	Main	0	0	A	U	Automatic setting (Factory default)
				00~15		Manual setting
Snow accumulation prevention control	Main	0	1	0	0	Disabled (Factory default)
				0	1	Enabled
Step for Silence mode	Main	0	2	0	0	Disabled (Factory default)
				0	1	Step1
				0	2	Step2
				0	3	Step3
Type of Silence mode	Main	0	3	0	0	Automatic Silence mode (Factory default)
				0	1	Manual Silence mode
Temperature unit	Main	0	4	0	0	Celsius (default)
				0	1	Fahrenheit
Not applicable	Main	0	5	0	0	Not applicable
				0	1	Not applicable
Current restriction rate <sup>1)</sup>	Main	0	6	0	0	100% (Factory default)
				0	1	95%
				0	2	90%
				0	3	85%
				0	4	80%
				0	5	75%
				0	6	70%
				0	7	65%
				0	8	60%
				0	9	55%
				1	0	50%
				1	1	100%
Dedicated mode for cooling/ heating <sup>2)</sup>	Main	0	7	0	0	Cooling / Heating operation (default)
				0	1	Cooling operation only
				0	2	Heating operation only

- 1) Current restriction rate : When restriction option is set, cooling and heating performance may decrease.
- 2) AC\*\*\*BXSCCC models are cooling-only models and do not support heating mode.  
These models operate in cooling mode only, even if "heating operation only" mode is enabled.

## Test operation mode and check mode (Cont.)

### ■ Auto check(Installation commissioning mode)

- This is a self-diagnosis function to determine the installation status and product integrity in the initial installation. (This model requires the Auto check to be implemented in the installation step before its normal operation is initiated.)
- Procedures of Auto check
  - 1 Check the product installation status.
    - Check the power supply, communication cables, service valve openings, and quantity of additional refrigerant.
    - In the initial power supply after installation, the warning of non-fulfilment of Auto check ( *UIP* ) will be indicated on the outdoor unit and the system will not function properly.
  - 2 Enter the mode of Auto check.
    - Press the K2 button 7 times consecutively.
    - During the Auto check, the display will show “ F ”, “ E ” “BLANK” “BLANK” and it will take about 10 to 30 minutes for completion.
  - 3 The mode of Auto check will then be completed.
    - Successful Auto check: After checking the blinking that indicates installation completion on the display ( *PASS* ), press the K1 or K2 button to turn the status to the standby mode for normal operation.
    - Failure of Auto check: An error code blinks on the display. Resolve the error by referring to the details on the Troubleshooting page about how to troubleshoot for each error code, and then perform the Auto check again.



- If you intend to install more refrigerant piping prior to entering the mode of Auto check, make sure that the refrigerant to be added meets the related requirements. In this process, it is possible to test the cooling test mode (K2 switch: once) and heating test mode (K1 switch: once).  
(※ AC\*\*\*BXSCCC models are cooling-only models and do not support heating test mode.)
- You may stop the mode of test operation for installation by pressing the K3 switch during the test operation.  
(After it stops, *UIP* (the warning of incomplete Auto check) will be displayed)
- During the Auto check, it is possible to refer to the system status by pressing the K4 switch.
- In the case that there is an error during the Auto check, the Auto check will stop. In this case, take a measure for the error and then try the test operation again.
- If the test operation is not completed properly, the product will not function in the intended way.  
*UIP* (no implementation of Auto check) will be displayed. Be sure to solve the trouble and complete the test operation for installation properly.
- *UIP* indicates, not that the unit is out of order, but that the Auto check has yet to be implemented as an essential step of installation.
- If you have completed the Auto check function normally once( *PASS* ) and run Auto check again,
  - **Successful Auto check:** After checking the blinking that indicates installation completion on the display ( *0000* )
  - **Failure of Auto check:** An error code blinks on the display. Resolve the error by referring to the details on the Troubleshooting page about how to troubleshoot for each error code, and then perform the Auto check again.



### 4-3-2. Error code [indoor]

■ 360 CST : AC\*\*\*BN6DCH



Condition	Indoor unit display indications			
	Ice blue	Yellow green	Blue	Red
Power reset. (blinking once every 2 seconds)	●	X	X	X
In the defrost operation. (blinking once every 10 seconds)	●	X	X	X
Open or short circuit error of the indoor-temperature sensor.	X	X	X	●
Error of the outdoor unit.	X	X	●	X
Communication error between the indoor and outdoor units	X	●	X	X
Open or short circuit error of a sensor (evaporator-in, evaporator-out, or discharge sensor) in the indoor unit.	X	●	X	●
Error of the fan in the indoor unit.	X	X	●	●
Error of the second detection of the oaf switch.	X	●	●	X
Open circuit error of the thermal fuse.	●	X	●	X
EEPROM error	●	●	X	●
MDS (Motion Detecting Sensor) Error	●	●	●	X

● : On, ● : Blinking, X : Off

**Error code [indoor] (Cont.)**



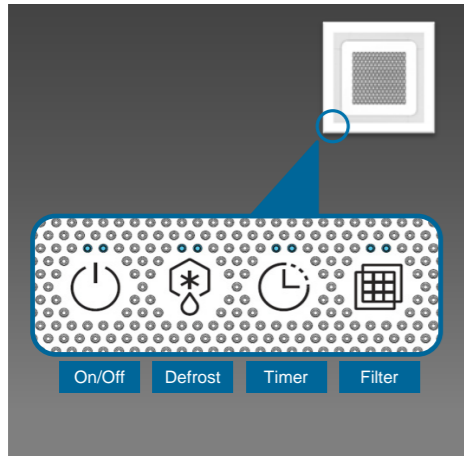

■ 4Way CST : AC\*\*\*BN4DCH



Error Mode				Cause	Measures	Product operation with error			Diagnosis method
Operation	Defrost	Timer	Filter			Outdoor heat exchanger compressor	Outdoor heat exchanger fan	Indoor heat exchanger fan	
●	X	X	X	Power reset	-	Operation-off	Operation-off	Operation-off	-
X	●	X	X	Error of room temperature sensor in the indoor unit (Open/Short)	<ul style="list-style-type: none"> <li>Check indoor temperature sensor connection.</li> <li>Check indoor temperature sensor's resistance value to see if it's short/open.</li> </ul>	Operation-off	Operation-off	Operation-off	-
●	●	X	X	Error of heat exchanger IN/OUT sensor in the indoor unit (Open/Short)	<ul style="list-style-type: none"> <li>Check EVA IN/OUT sensor connection.</li> <li>Check EVA IN/OUT sensor's resistance value to see if it's short/open.</li> </ul>	Operation-off	Operation-off	Operation-off	-
X	X	●	X	Error of fan motor in the indoor unit	<ul style="list-style-type: none"> <li>Check the connection of motor connector</li> <li>Check the speed of the motor fan</li> </ul>	Operation-off	Operation-off	Operation-off	-
●	X	●	X	Error of the outdoor temperature sensor Error of the condenser temperature sensor Error of the discharge temperature sensor	<ul style="list-style-type: none"> <li>Check indoor temperature sensor connection.</li> <li>Check indoor temperature sensor's resistance value to see if it's short/open.</li> </ul>	Operation-off	Operation-off	Operation-off	-
X	●	●	X	No communication for 2 minutes between indoor and outdoor unit (communication error for more than 2 minutes)	<ul style="list-style-type: none"> <li>Check connection between indoor and outdoor heat exchangers' communication cables</li> </ul>	Operation-off	Operation-off	Operation-off	-
X	●	●	●	Error of outdoor unit	<ul style="list-style-type: none"> <li>Check error occurred with outdoor heat exchanger.</li> <li>TERMINAL Block thermal FUSE error.(OPEN)</li> </ul>	Operation-off	Operation-off	Operation-off	-
X	X	●	●	Detection of the float switch	<ul style="list-style-type: none"> <li>Check float switch connection.</li> <li>Check whether the drain has been filled with water.</li> </ul>	Operation-off	Operation-off	Operation-off	-
●	●	●	●	EEPROM error EEPROM option error	<ul style="list-style-type: none"> <li>Check if there is damage with EEPROM component.</li> <li>Check the indoor model to set the options.</li> <li>Inspection for match between indoor and outdoor machine models</li> </ul>	Operation-off	Operation-off	Operation-off	-
●	X	●	●	Outdoor valve clogging error.	<ul style="list-style-type: none"> <li>High pressure check valve clogging.</li> </ul>	Operation-off	Operation-off	Operation-off	-
●	X	X	●	MDS (Motion Detecting Sensor) Error	<ul style="list-style-type: none"> <li>Check MDS</li> </ul>	-	-	-	-
●	●	X	●	Error due to connecting outdoor units that do not support the Wind-Free function	<ul style="list-style-type: none"> <li>Check outdoor main PBA S/W Check outdoor EEPROM</li> </ul>	-	-	-	-

○: On / ●: Blink / X: Off

■ 4way Cassette(600x600) : AC\*\*\*BNNDCH

Abnormal conditions	LED lamp display				Remarks
	Operation	Defrost	Timer	Filter	
					
Power reset	●	X	X	X	
Error of temperature sensor in the indoor unit (Open/ Short)	X	●	X	X	
Error of heat exchanger sensor in the indoor unit (Open/Short)	●	●	X	X	
Error of fan motor in the indoor unit	X	X	●	X	
Error of the outdoor temperature sensor Error of the condensor temperature sensor Error of the discharge temperature sensor	●	X	●	X	
No communication for 2 minutes between indoor and outdoor unit (communication error for more than 2 minutes)	X	●	●	X	
Error of outdoor unit Error of the terminal block thermal fuse (Open)	X	●	●	●	
Detection of the float switch	X	X	●	●	
EEPROM ERROR EEPROM option error	●	●	●	●	
Outdoor valve clogging error	●	X	●	●	
Miss matching error between indoor unit and outdoor unit	●	●	X	●	

● : On, ◐ : Flickering, X : Off

- If you turn off the air conditioner when the LED is flickering, the LED is also turned off.

■ 1way Cassette : AC\*\*\*BN1DCH

Abnormal conditions	LED lamp display				Filter reset	Remarks
	Operation	Defrost	Timer	Fan		
	Blue	Yellow				
	⏻		🕒	🌀		
Power reset	●	X	X	X	X	
Error of temperature sensor in the indoor unit (Open/ Short)	X	X	●	X	X	
Error of heat exchanger sensor in the indoor unit	●	X	●	X	X	
Error of the outdoor temperature sensor Error of the condensor temperature sensor Error of the discharge temperature sensor	●	X	X	●	X	
1. No communication for 2 minutes between indoor units (Communication error for more than 2 minutes) 2. Indoor unit receiving the communication error from outdoor unit 3. Outdoor unit tracking 3 minutes error 4. When sending the communication error from the outdoor unit, the mismatching of the communication numbers and installed numbers after completion of tracking. (Communication error for more than 2 minutes)	X	X	●	●	X	1. Indoor unit error (Display is unrelated with operation) 2. Outdoor unit error (Display is unrelated with operation)
1. Error of electronic expansion valve open 2. 2'nd detection of high temperature cond 3. 2'nd detection of high temperature discharge 4. Error of reverse phase 5. Compressor down due to 6th detection of freezing	X	X	●	●	●	
Detection of the float switch	X	X	X	●	●	
"EEPROM error EEPROM option error"	●	●	●	●	●	
Error on indoor fan motor (E154)	X	X	X	●	X	
Outdoor valve clogging error	●	X	●	●	X	
Error due to connecting outdoor units that do not support the WindFree function	●	●	X	●	X	

● : On, ◐ : Flickering, X : Off

• If you turn off the air conditioner when the LED is flickering, the LED is also turned off.

■ Home Duct, Duct S : AC\*\*\*BNLDCH, AC\*\*\*BNHDCH

Abnormal conditions	Indicators					Operating	
	Concealed Type		Green	Red	Fan		Filter
	Green	Red					
	Standard Type		Green	Red	Fan		Filter
	Green	Red					
Power reset	●	x	x	x	x		
Error of Room sensor in the indoor unit(Open/Short)	x	x	●	x	x		
Error of EVA-IN,EVA-OUT sensor in the indoor unit (Open/Short)	●	x	●	x	x		
Error of Fan motor in the indoor unit	x	x	x	●	x		
Error of Outdoor or Terminal Block Thermal Fuse (Open)	x	x	●	●	●		
Clogging of outdoor's service valve	●	x	x	●	●		
Detection of the float switch	x	x	x	●	●		
Error of EEPROM or OPTION SETTING	●	●	●	●	●		
1. No communication for 2 minutes between indoor units (Communication error for more than 2 minutes) 2. Indoor unit receiving the communication error from outdoor unit 3. Outdoor unit tracking 3 minutes error 4. When sending the communication error from the outdoor unit, the mismatching of the communication numbers and installed numbers after completion of tracking. (Communication error for more than 2 minutes)	x	x	●	●	x	1. Indoor unit error (Display is unrelated with operation) 2. Outdoor unit error (Display is unrelated with operation)	

● : On, ● : Flickering, X : Off

• If you turn off the air conditioner when the LED is flickering, the LED is also turned off.

■ RAC : AC\*\*\*BNADCH













Abnormal condition	Error code
Error on indoor temperature sensor (Short or Open)	E121
1. Error on Eva-in sensor (Short or Open) 2. Error on Eva-out sensor (Short or Open) 3. Discharge sensor error (Short or Open)	E122 E123 E126
Indoor fan error	E154
1. Error on outdoor temperature sensor (Short or Open) 2. Error on cond sensor 3. Error on discharge sensor Other outdoor unit sensor error that is not on the above list	E221 E237 E251 E101
1. When there is no communication between the indoor-outdoor units for 2 minutes 2. Communication error received from the outdoor unit 3. 3 minute tracking error on outdoor unit 4. Communication error after tracking due to unmatching number of installed units 5. Error due to repeated communication address 6. Communication address not confirmed Other outdoor unit communication error that is not on the above list	E102 E202 E201 E108 E109
Self diagnosis error display 1. Error due to opened EEV (2nd detection) 2. Error due to closed EEV (2nd detection) 3. Eva in sensor is detached 4. Eva out sensor is detached 5. Thermal fuse error (Open)	E151 E152 E128 E129 E198
1. COND mid sensor is detached 2. Refrigerant leakage (2nd detection) 3. Abnormally high temperature on Cond (2nd detection) 4. Low pressure s/w (2nd detection) 5. Abnormally high temperature on discharged air on outdoor unit (2nd detection) 6. Indoor operation stop due to unconfirmed error on outdoor unit 7. Error due to reverse phase detection 8. Comp stop due to freeze detection (6th detection) 9. High pressure sensor is detached 10. Low pressure sensor is detached 11. Outdoor unit copression ration error 12. Outdoor sump down_1 prevetion control 13. Compressor down due to low pressure sensor prevention control_1 14. Simultaneous opening of cooling/heating MCU SOL valve (1st detection) 15. Simultaneous opening of cooling/heating MCU SOL valve (2nd detection) 16. External floating Switch error Other outdoor unit self-diagnosis error that is not on the above list	E241 E554 E450 E451 E416 E559 E425 E403 E301 E306 E428 E413 E410 E180 E181 E665
EEPROM error	E162

■ RAC : AC\*\*\*BNTDCH





Abnormal condition	Error code	LED Display		
Error on indoor temperature sensor (Short or Open)	E121	X		X
1. Error on Eva-in sensor (Short or Open) 2. Error on Eva-out sensor (Short or Open) 3. Discharge sensor error (Short or Open)	E122 E123 E126			X
Indoor fan error	E154	X	X	
1. Error on outdoor temperature sensor (Short or Open) 2. Error on cond sensor 3. Error on discharge sensor Other outdoor unit sensor error that is not on the above list	E221 E237 E251		X	
1. When there is no communication between the indoor-outdoor units for 2 minutes 2. Communication error received from the outdoor unit 3. 3 minute tracking error on outdoor unit 4. Communication error after tracking due to unmatching number of installed units 5. Error due to repeated communication address 6. Communication address not confirmed Other outdoor unit communication error that is not on the above list	E101 E102 E202 E201 E108 E109	X		
Self diagnosis error display 1. Error due to opened EEV (2nd detection) 2. Error due to closed EEV (2nd detection) 3. Eva in sensor is detached 4. Eva out sensor is detached 5. Thermal fuse error (Open)	E151 E152 E128 E129 E198			
1. COND mid sensor is detached 2. Refrigerant leakage (2nd detection) 3. Abnormally high temperature on Cond (2nd detection) 4. Low pressure s/w (2nd detection) 5. Abnormally high temperature on discharged air on outdoor unit (2nd detection) 6. Indoor operation stop due to unconfirmed error on outdoor unit 7. Error due to reverse phase detection 8. Comp stop due to freeze detection (6th detection) 9. High pressure sensor is detached 10. Low pressure sensor is detached 11. Outdoor unit copression ration error 12. Outdoor sump down_1 prevetion control 13. Compressor down due to low pressure sensor prevention control_1 14. Simultaneous opening of cooling/heating MCU SOL valve (1st detection) 15. Simultaneous opening of cooling/heating MCU SOL valve (2nd detection) 16. External floating Switch error Other outdoor unit self-diagnosis error that is not on the above list"	E241 E554 E450 E451 E416 E559 E425 E403 E301 E306 E428 E413 E410 E180 E181 E665			
EEPROM error	E162			

● : On, : Flickering, X : Off

■ Console : AC\*\*\*BNJDCH

Abnormal condition	Error code	LED Display				
		...				
Error on indoor temperature sensor (Short or Open)	E121	X	X		X	X
1. Error on Eva-in sensor (Short or Open) 2. Error on Eva-out sensor (Short or Open) 3. Discharge sensor error (Short or Open)	E122 E123 E126	X	X		X	
Indoor fan error	E154	X		X	X	X
1. Error on outdoor temperature sensor (Short or Open) 2. Error on cond sensor 3. Error on discharge sensor Other outdoor unit sensor error that is not on the above list	E221 E237 E251	X		X	X	
1. When there is no communication between the indoor-outdoor units for 2 minutes 2. Communication error received from the outdoor unit 3. 3 minute tracking error on outdoor unit 4. Communication error after tracking due to unmatching number of installed units 5. Error due to repeated communication address 6. Communication address not confirmed Other outdoor unit communication error that is not on the above list	E101  E102 E202 E201  E108 E109	X			X	X
Self diagnosis error display 1. Error due to opened EEV (2nd detection) 2. Error due to closed EEV (2nd detection) 3. Eva in sensor is detached 4. Eva out sensor is detached 5. Thermal fuse error (Open)	E151 E152 E128 E129 E198				X	X
1. COND mid sensor is detached 2. Refrigerant leakage (2nd detection) 3. Abnormally high temperature on Cond (2nd detection) 4. Low pressure s/w (2nd detection) 5. Abnormally high temperature on discharged air on outdoor unit (2nd detection) 6. Indoor operation stop due to unconfirmed error on outdoor unit 7. Error due to reverse phase detection 8. Comp stop due to freeze detection (6th detection) 9. High pressure sensor is detached 10. Low pressure sensor is detached 11. Outdoor unit copression ration error 12. Outdoor sump down_1 prevetion control 13. Compressor down due to low pressure sensor prevention control_1 14. Simultaneous opening of cooling/heating MCU SOL valve (1st detection) 15. Simultaneous opening of cooling/heating MCU SOL valve (2nd detection) Other outdoor unit self-diagnosis error that is not on the above list	E241 E554 E450 E451 E416  E559 E425 E403 E301 E306 E428 E413 E410 E180  E181				X	X

















Abnormal condition	Error code	LED Display				
		...				
1. Floating s/w (2nd detection) 2. External floating Switch error	E153 E665	●	●	X	X	X
EEPROM error	E162	●	●	●	●	●
EEPROM option error	E163	●	●	●	●	●
Error due to incompatible indoor unit	E164	●	X	X	X	X

● : On, ◐ : Flickering, X : Off

- If you turn off the air conditioner when the LED is flickering, the LED is also turned off.

## 4-4. Troubleshooting by symptoms

### 4-4-1. Indoor temperature sensor error (E121)

Display	Outdoor Unit display		E121															
	Wired remote Control, Wind Free RAC		E121															
	Duct, 1way Cassette			4way Cassette, 4way Cassette(600x600)				MAX4			Console			360 Cassette				
	 Duct Blue   Red 1way Blue   Yellow		or 	or 	or 								...					Red ●
	X	X	●	X	X	X	●	X	X	X	●	X	X	X	●	X	X	
Judgment method	Refer to checking method, as shown below.																	
Symptom	If the indoor temperature sensor is open or short circuit.																	

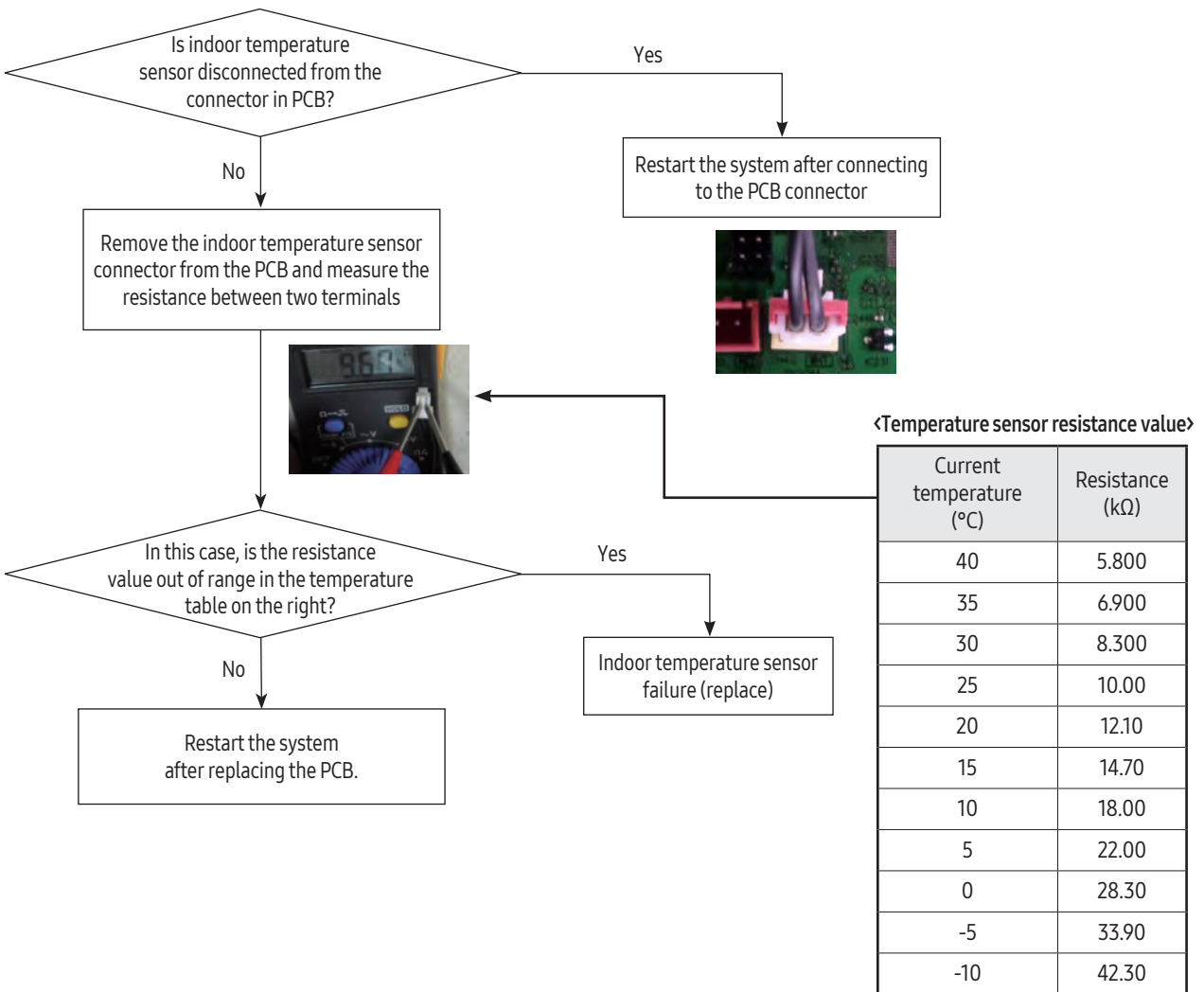

### 4-4-2. Indoor heat exchanger temperature sensor error (E122)

Display	Outdoor Unit display		E122													
	Wired remote Control, Wind Free RAC		E122, E123													
	Duct, 1way Cassette			4way Cassette, 4way Cassette(600x600)				MAX4		Console				360 Cassette		
Blue	Red	or	or	or	○	○	X	X	○	○	X	X	X	○	X	○
Blue	Yellow				○	○	X	X	○	○	X	X	X	○	X	○
○	X	○	X	X	○	○	X	X	○	○	X	X	X	○	X	○
Judgment method	Refer to checking method, as shown below															
Symptom	If the short or open circuit of indoor heat exchanger temperature sensor.															

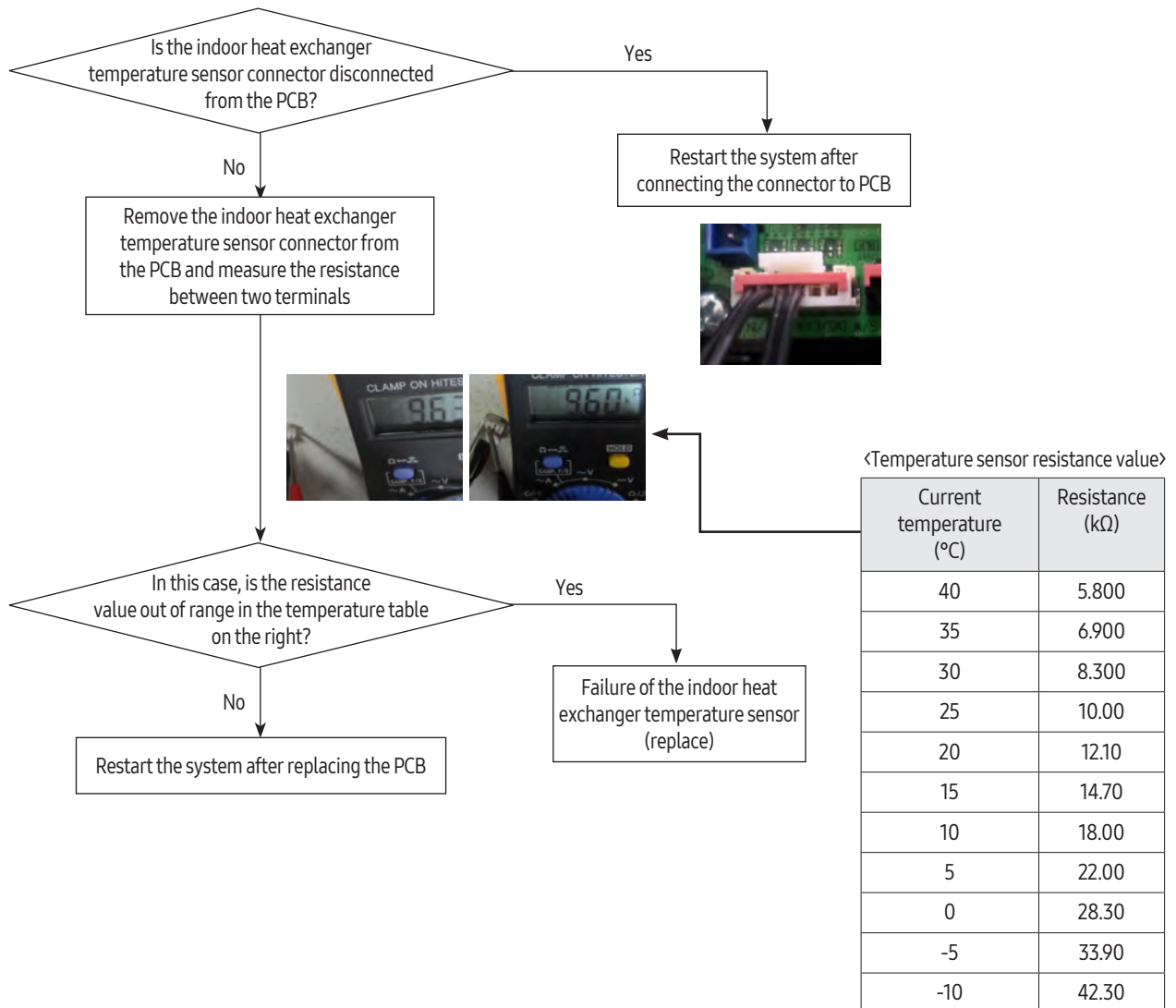

### 4-4-3. Indoor unit float sensor error (E153)

Display	Outdoor Unit display		E153							
	Wired remote Control, Wind Free RAC		E153							
	Duct, 1way Cassette			4way Cassette, 4way Cassette(600x600)				360 Cassette		
										GRN ● ↔ BLUE ●
	Duct		or	or	or					
Blue	Red									
1way										
Blue	Yellow									
	X	X	X	●	●	X	X	●	●	
Judgment method	Refer to checking method, as shown below									
Symptom	If the increase in the drain pan water level due to failure of the indoor unit drain pump or indoor unit float switch is open and that state is maintained for more than one minute.									

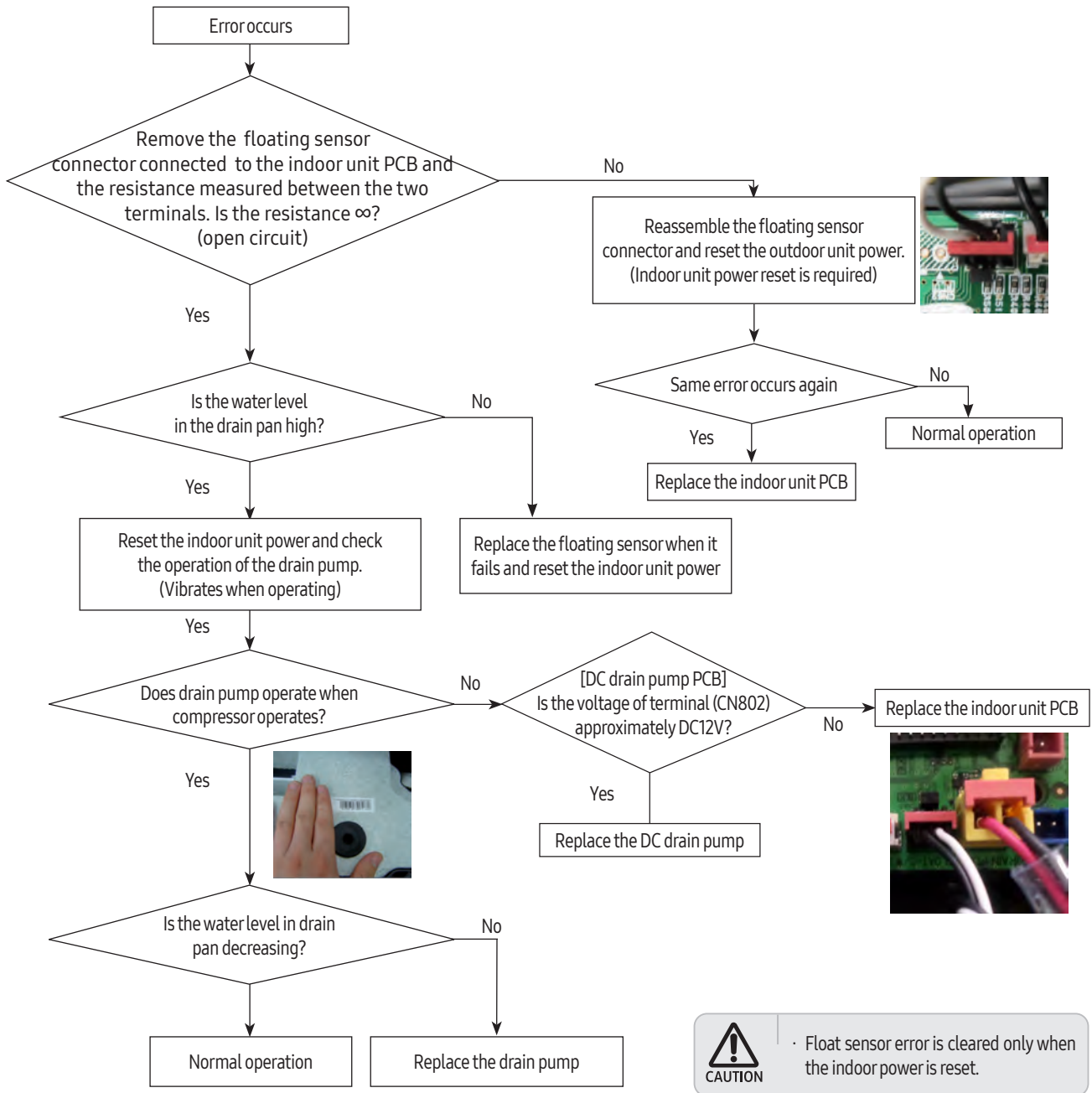

### 4-4-4. Indoor Fan error (E154)

Display	Outdoor Unit display		E154																
	Wired remote Control, Wind Free RAC		E154																
	Duct, 1way Cassette			4way Cassette, 4way Cassette(600x600)				MAX4			Console				360 Cassette				
	Duct Blue   Red		or [Clock]	or [Fan]	or [Grid]	[Power]	[Shield]	[Clock]	[Grid]	[Power]	[Clock]	[Turbid]	[Dots]	[Fan]	[Clock]	[Shield]	[Black Circle]	RED ● ↔ BLU ●	
	1way Blue   Yellow		[Clock]	[Fan]	[Grid]	X	X	[Clock]	X	X	X	[Turbid]	X	[Fan]	X	X	X		
X		X	X	○	X	X	○	X	X	X	○	X	○	X	X	X			
Judgment method	Refer to checking method, as shown below																		
Symptom	If the motor connector break away / Indoor unit Fan does not operate by motor or PBA defectiveness.																		

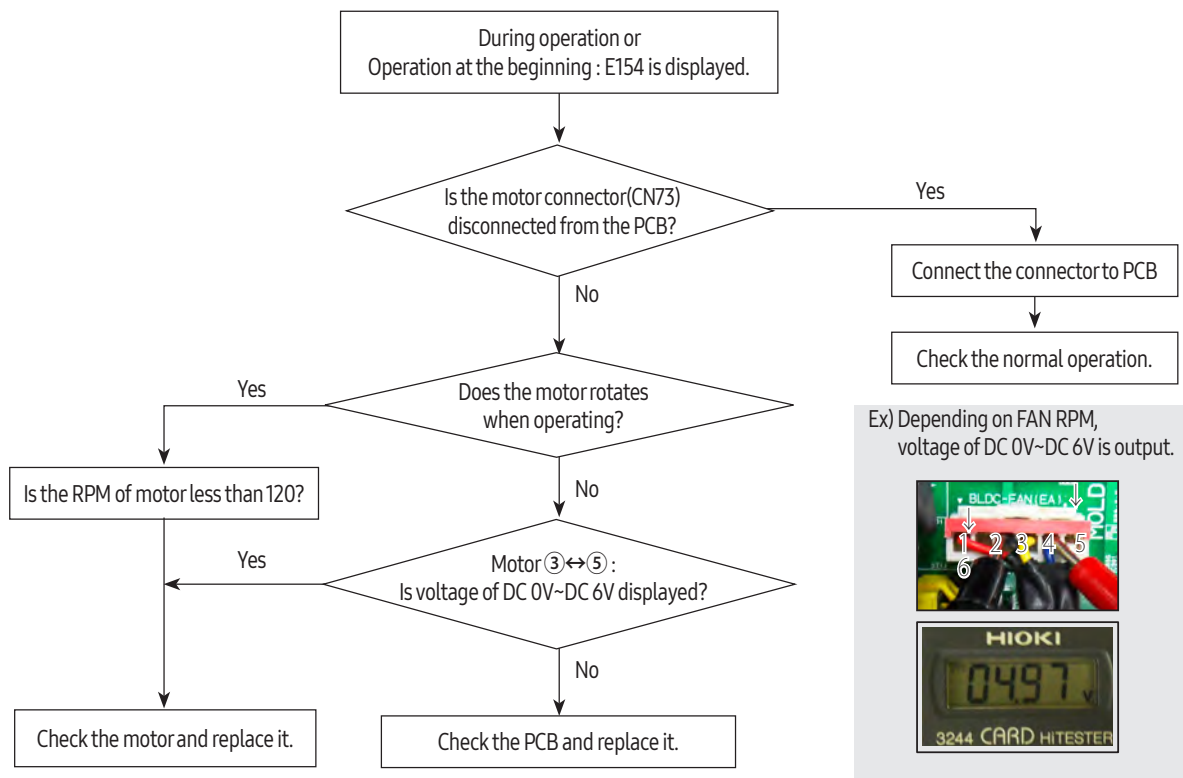



### 4-4-6. Communication error after finishing Tracking (E202)

Display	Outdoor Unit display		E202														
	Wired remote Control, Wind Free RAC		E202														
	Duct, 1way Cassette			4way Cassette, 4way Cassette(600x600)				MAX4			Console				360 Cassette		
	 Duct Blue Red 1way Blue Yellow X X		 or  or  or X	 or  or  or X	 X	 X	 X	 X	 X	 X	 X	 X	 X	 X	 X	 X	GRN ●
	Judgment method																
Symptom																	

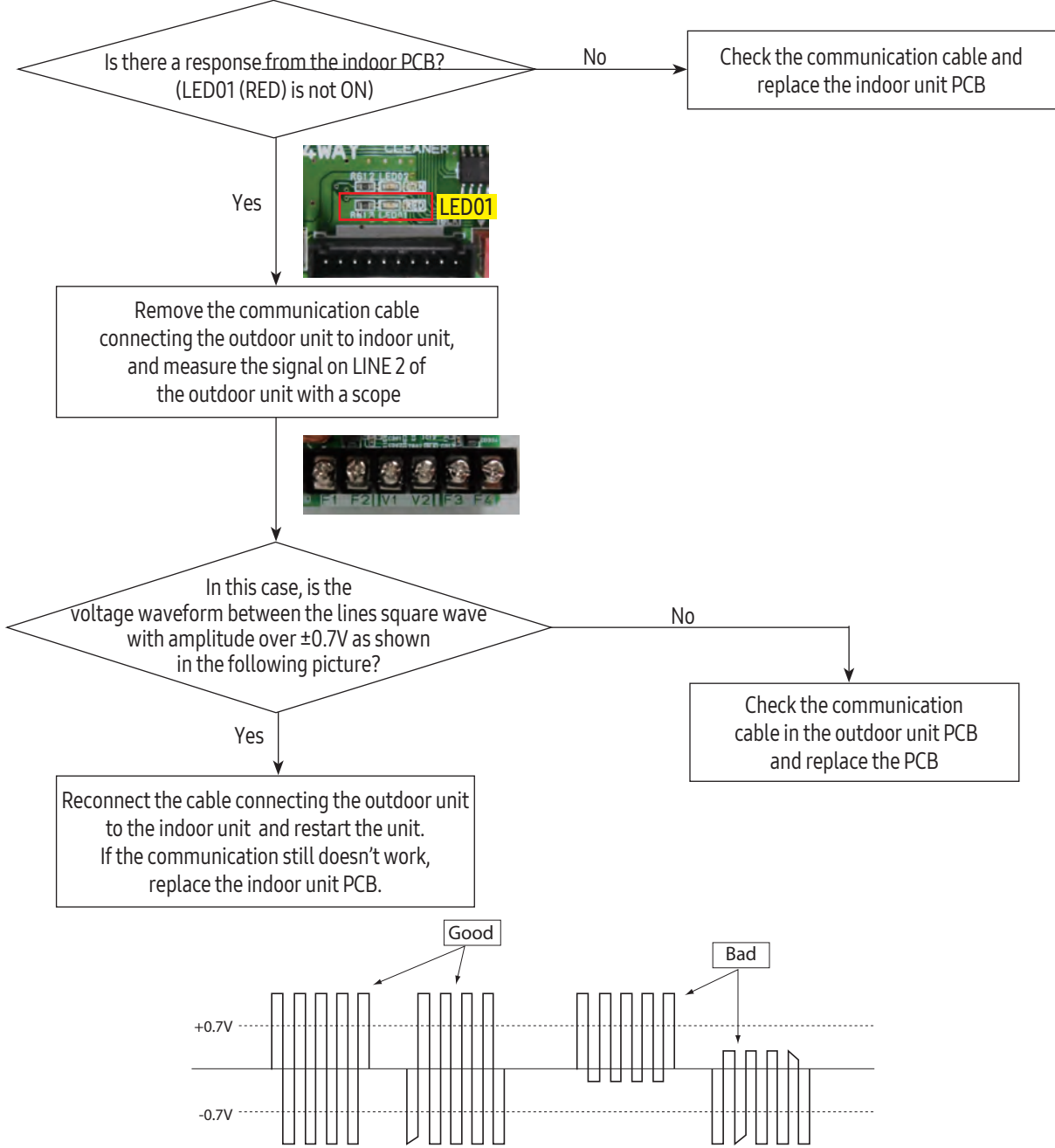

### 4-4-7. The whistling noise from the indoor unit in low wind mode

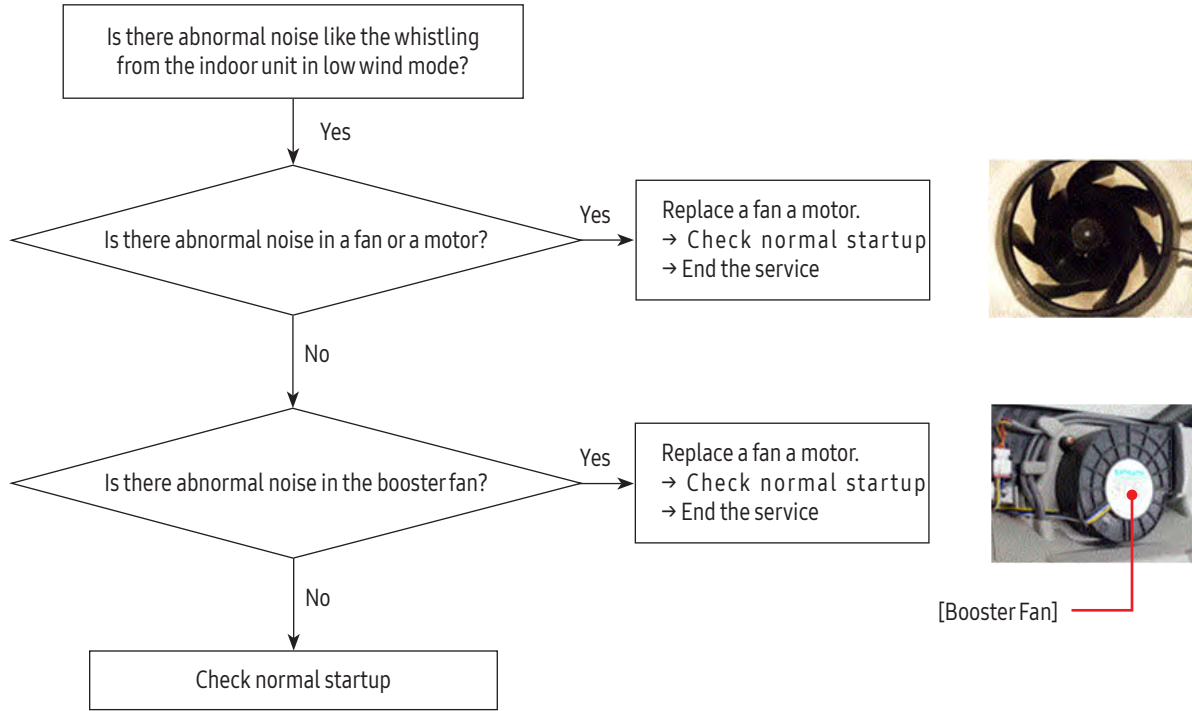



### 4-4-8. When the outdoor unit power is not ON - Initial Diagnosis : 1-phase products

1. Test items

- 1) Check the power connection of outdoor unit.
- 2) Check the whole connection part of the power wire.
- 3) Check the power on the indoor unit.
- 4) Check the connection of the power wire of the Terminal Block.
- 5) Check the connection of the power wire between the Main ↔ EMI PBA of the outdoor unit.
- 6) Connect the power wire. (Never forget to turn off the power of the Terminal Box).
- 7) Check the power supply parts. (Check after turning off the power of the Terminal Box!)
- 8) Check everything is normal after separating the fan motor connector and resetting the power.  
(Separate the connector after turning off the power of the Terminal Box! When detaching and attaching the connector during power supply, the motor can be damaged.)

- 7-segment off.
- Conduct the following test if the mode is not Eco-mode (power saving mode).

2. Check procedure

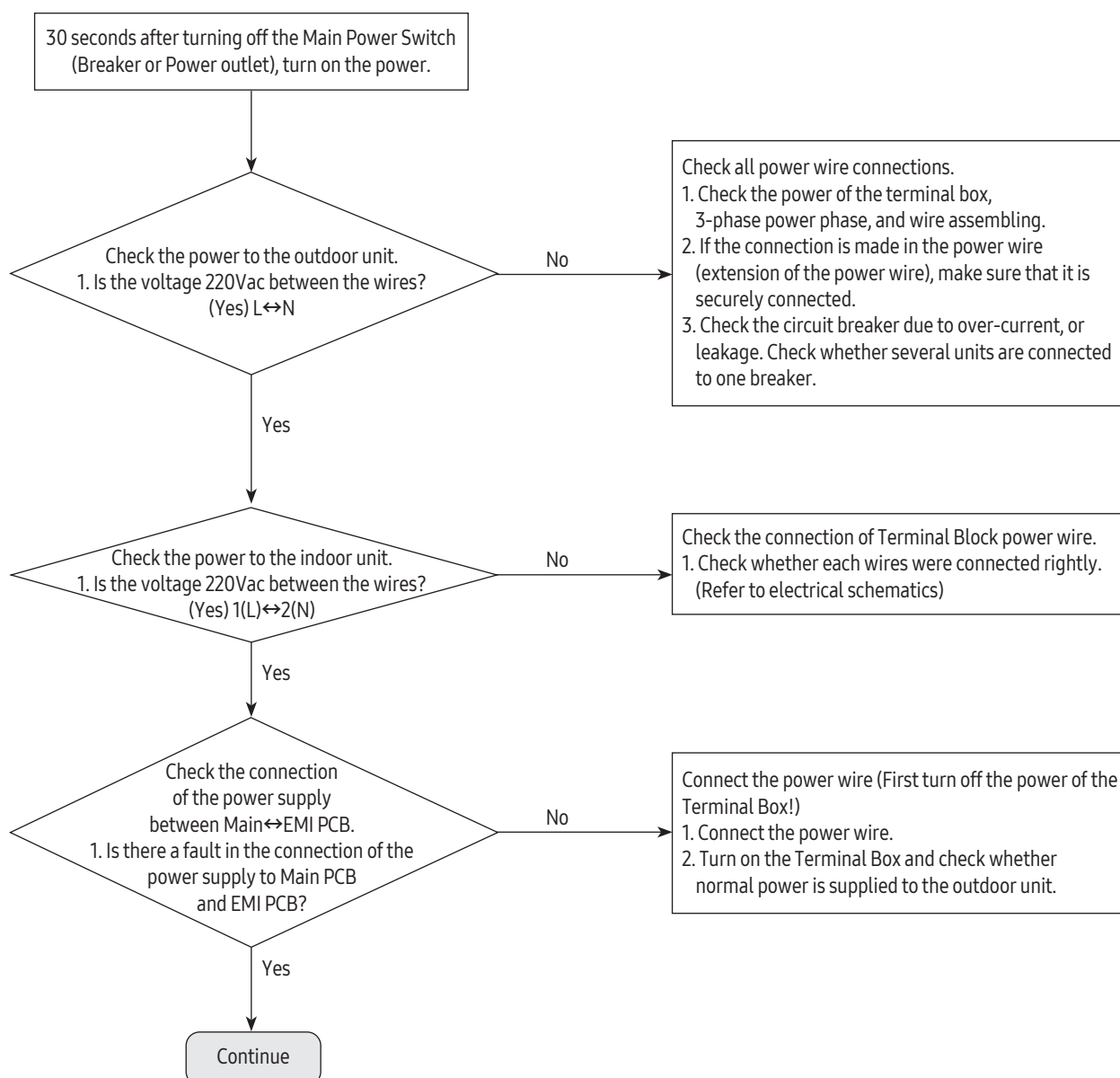

### When the outdoor unit power is not ON - Initial Diagnosis : 1-phase products (Cont.)

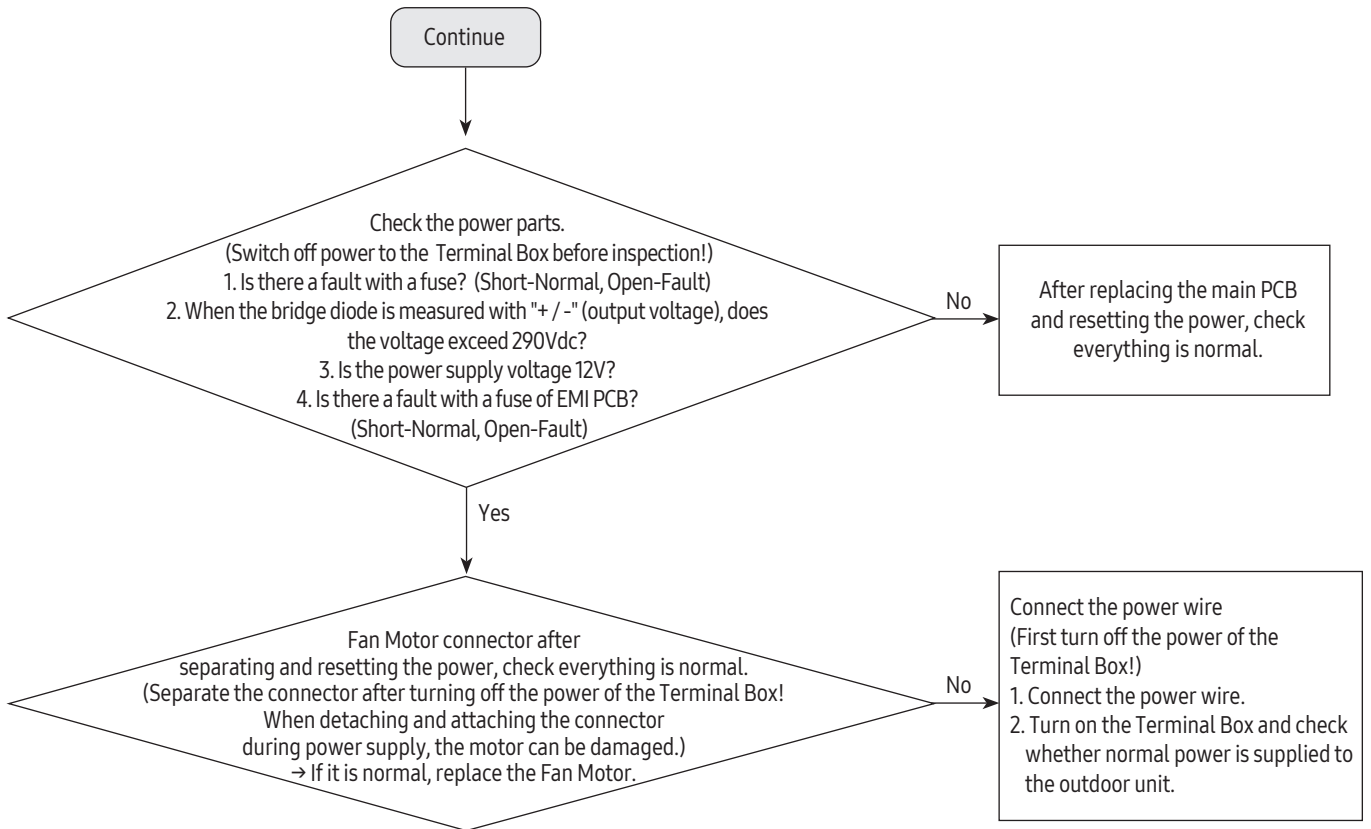

### 4-4-9. Indoor/outdoor communication error (2min.) (Error Code : E202)

Display	Outdoor Unit display		E202													
	Wired remote Control, Wind Free RAC		E202													
	Duct, 1way Cassette			4way Cassette, 4way Cassette(600x600)				MAX4			Console				360 Cassette	
	Duct Blue Red 1way Blue Yellow		or or or													GRN
	X	X			X	X			X	X			X			X
Judgment method	Refer to checking method, as shown below															
Symptom	Communication error between the indoor and outdoor unit for two minutes															

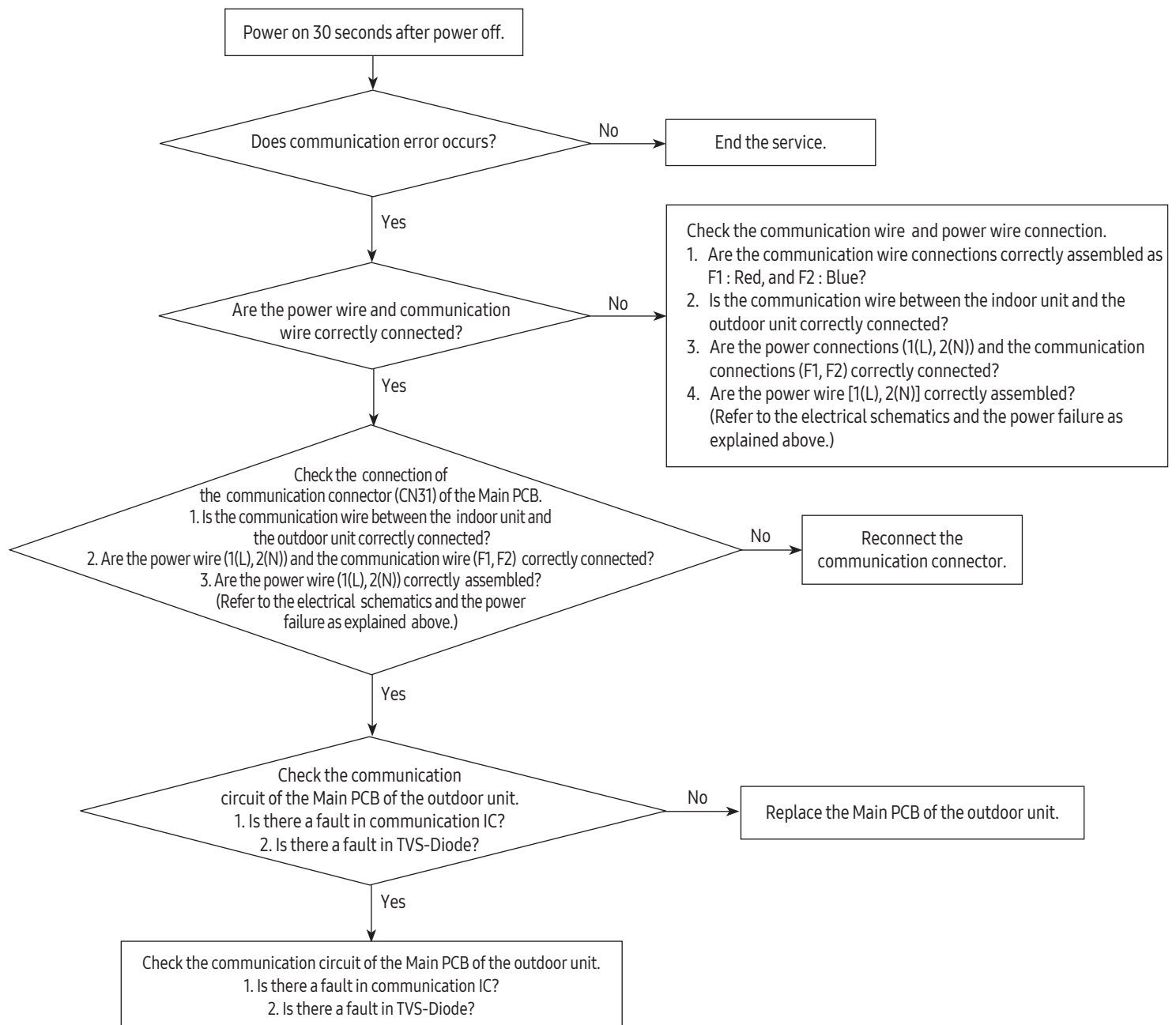



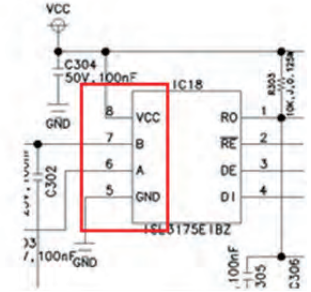
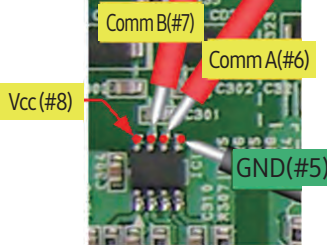
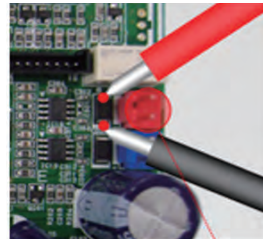















**Indoor/outdoor communication error (2 min.) (Error Code: E202) (Cont.)**

Measuring Part	Communication IC Measuring Part (Circuit Diagram)	Example of Measuring Communication IC	Example of Measuring TVS-Diode
Location			
Measuring Point	#5-GND, #6- Communication A, #7-Communication B, #8-Vcc		

Communication IC Measuring (Port)	Steady-state Measuring Value	Remark
	COM 1(RED)	
#6 - #5	0.9kΩ ~ 1.2kΩ	Measuring after separating the communication connection
#7 - #5	0.9kΩ ~ 1.2kΩ	
#8 - #5	4.7Vdc ~ 5.3Vdc	
TVS-Diode Measuring		Steady-state Measuring Value
Both ends of diode		1kΩ or above

### 4-4-10. Communication error between outdoor unit INV ↔ MAIN MICOM (1 min.) (Error Code: E203)

Display	Outdoor Unit display		E203															
	Wired remote Control, Wind Free RAC		E203															
	Duct, 1way Cassette		4way Cassette, 4way Cassette(600x600)				MAX4			Console				360 Cassette				
	 Duct Blue   Red 1way Blue   Yellow		 or 	 or 	 or 													GRN ●
	X	X	●	●	X	X	●	●	X	X	●	●	X	●	●	X	X	
Judgment method																		
Refer to checking method, as shown below																		
Symptom																		
Communication error between the outdoor unit INV and Main Micom for one minutes																		

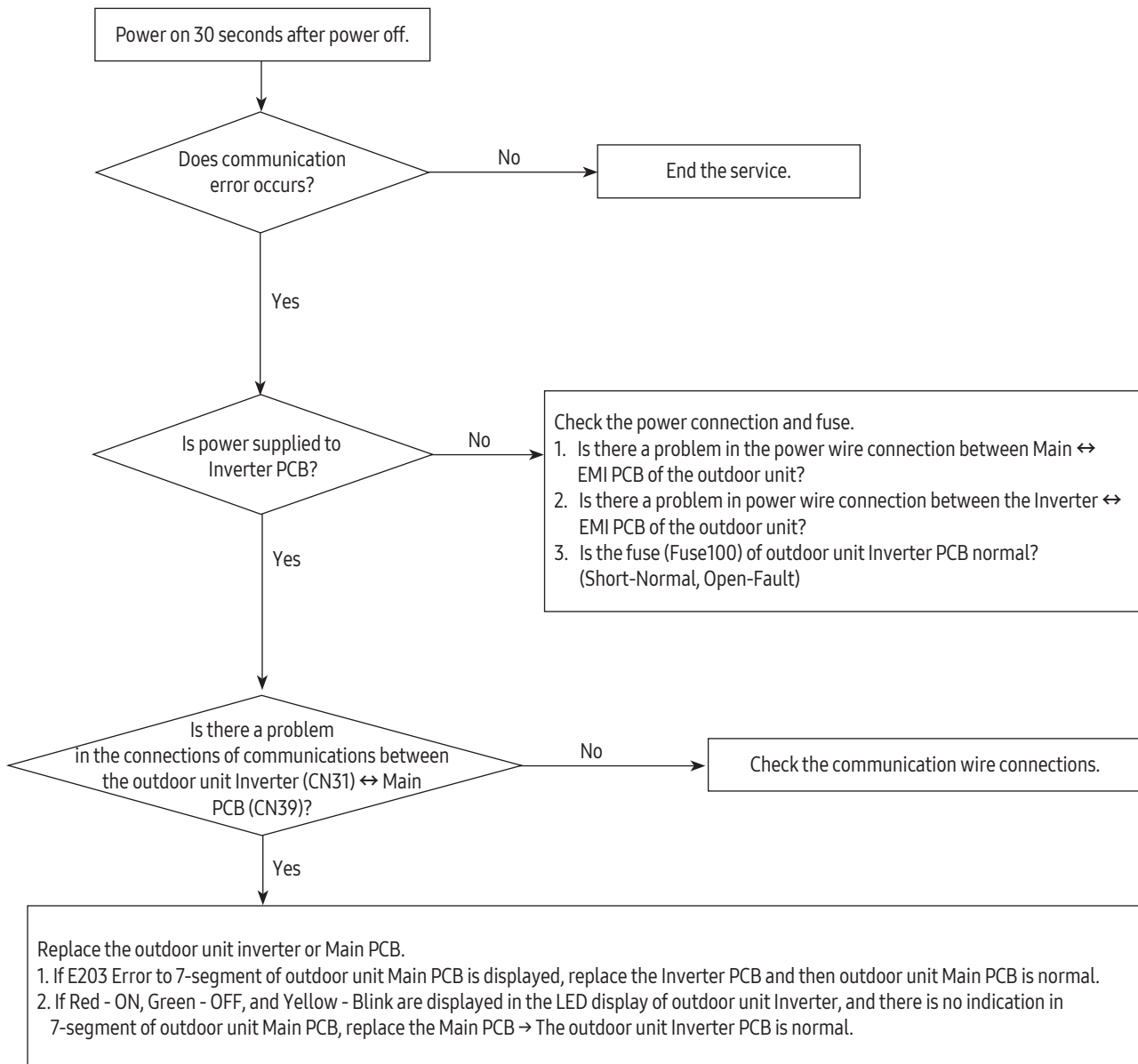

### 4-4-11. Outdoor sensor error(Error Code : E221, E231, E251, E320)

Display	Outdoor Unit display		E221,E231,E251,E320														
	Wired remote Control, Wind Free RAC		E221,E231,E251,E320														
	Duct, 1way Cassette		4way Cassette, 4way Cassette(600x600)				MAX4			Console				360 Cassette			
	Duct Blue   Red 1way Blue   Yellow		or 	or 	or 												
		X	X		X		X		X		X		X		X	X	
Judgment method	Refer to checking method, as shown below.																
Symtom																	

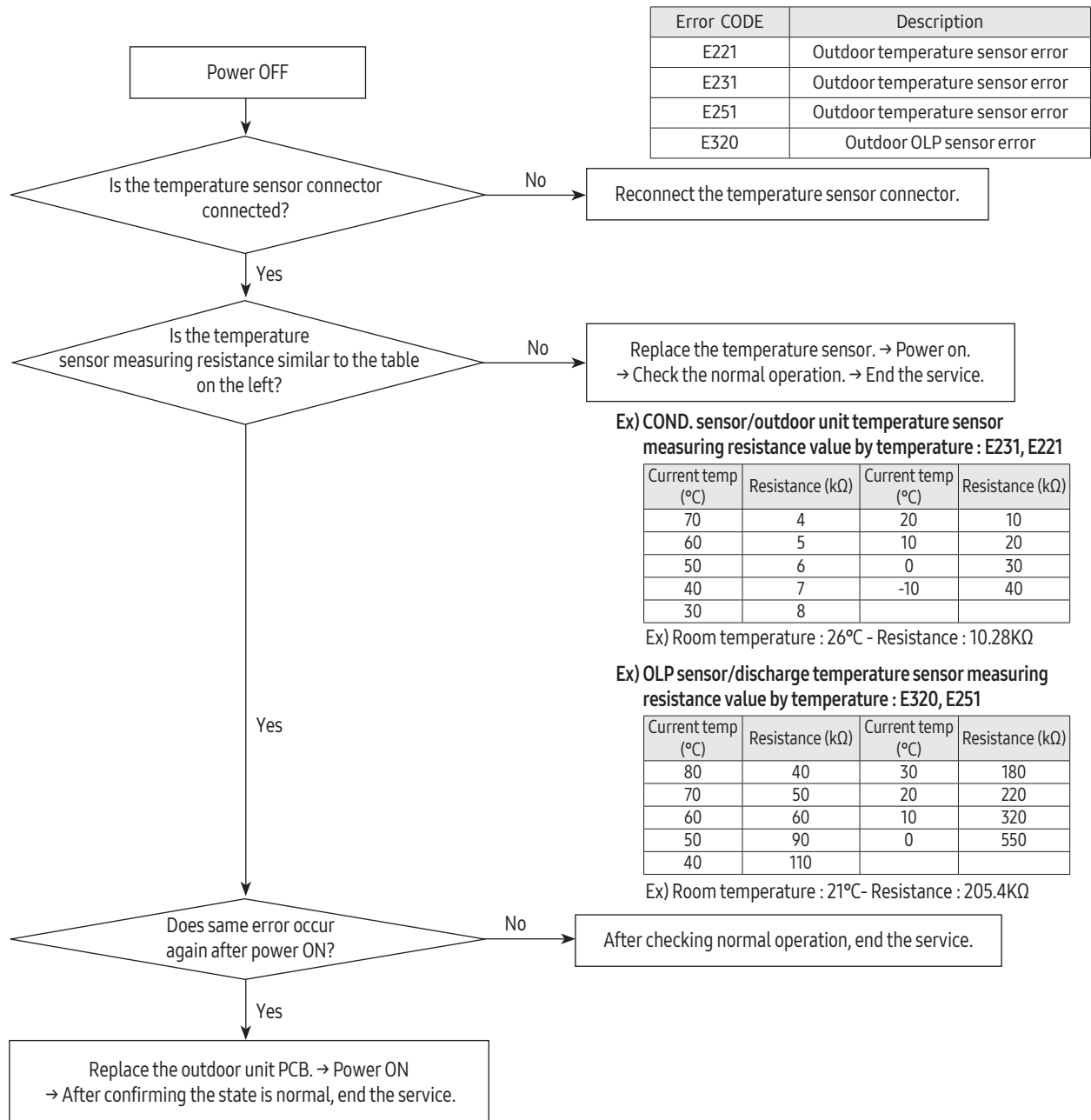





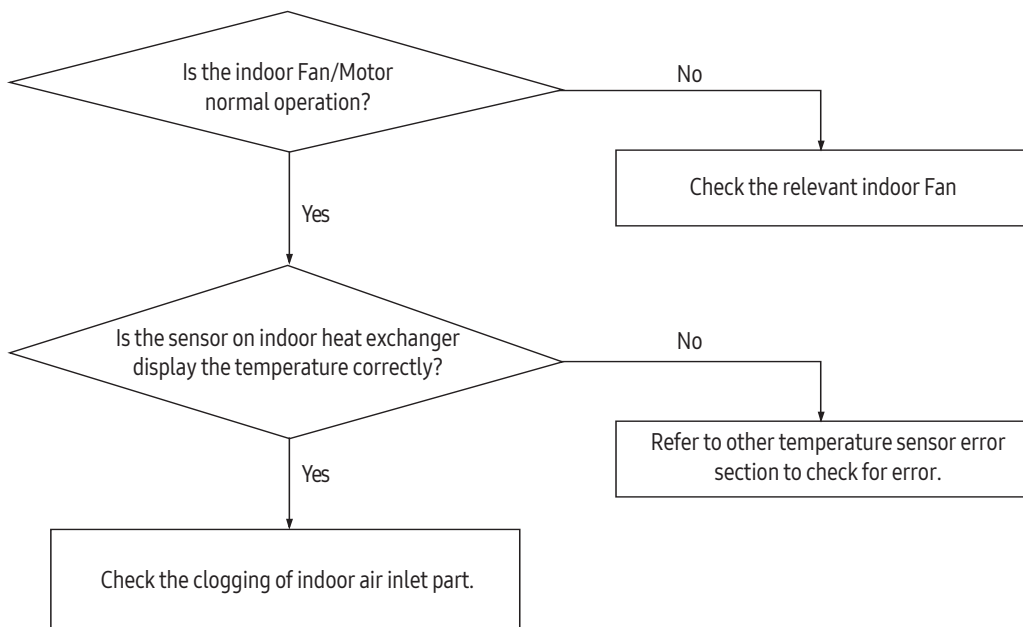















### 4-4-12. Compressor down due to freezing control (Error Code : E403)

Display	Outdoor Unit display		E403															
	Wired remote Control, Wind Free RAC		E403															
	Duct, 1way Cassette			4way Cassette, 4way Cassette(600x600)				MAX4			Console				360 Cassette			
	 Duct Blue Red 1way Blue Yellow		 or 	 or 	 or 													BLUE
	X	X				X											X	X
Judgment method	Refer to checking method, as shown below.																	
Symtom																		



### 4-4-13. Pipe blockage error (Error Code : E422)

Display	Outdoor Unit display		E422															
	Wired remote Control, Wind Free RAC		E422															
	Duct, 1way Cassette			4way Cassette, 4way Cassette(600x600)				MAX4		Console				360 Cassette				
	 Duct Blue Red 1way Blue Yellow		 or 	 or 	 or 													BLUE 
	●	X	X	●	●	●	X	●	●	●	●	●	●	●	X	X	●	
Judgment method	Refer to checking method, as shown below.																	
Symptom																		

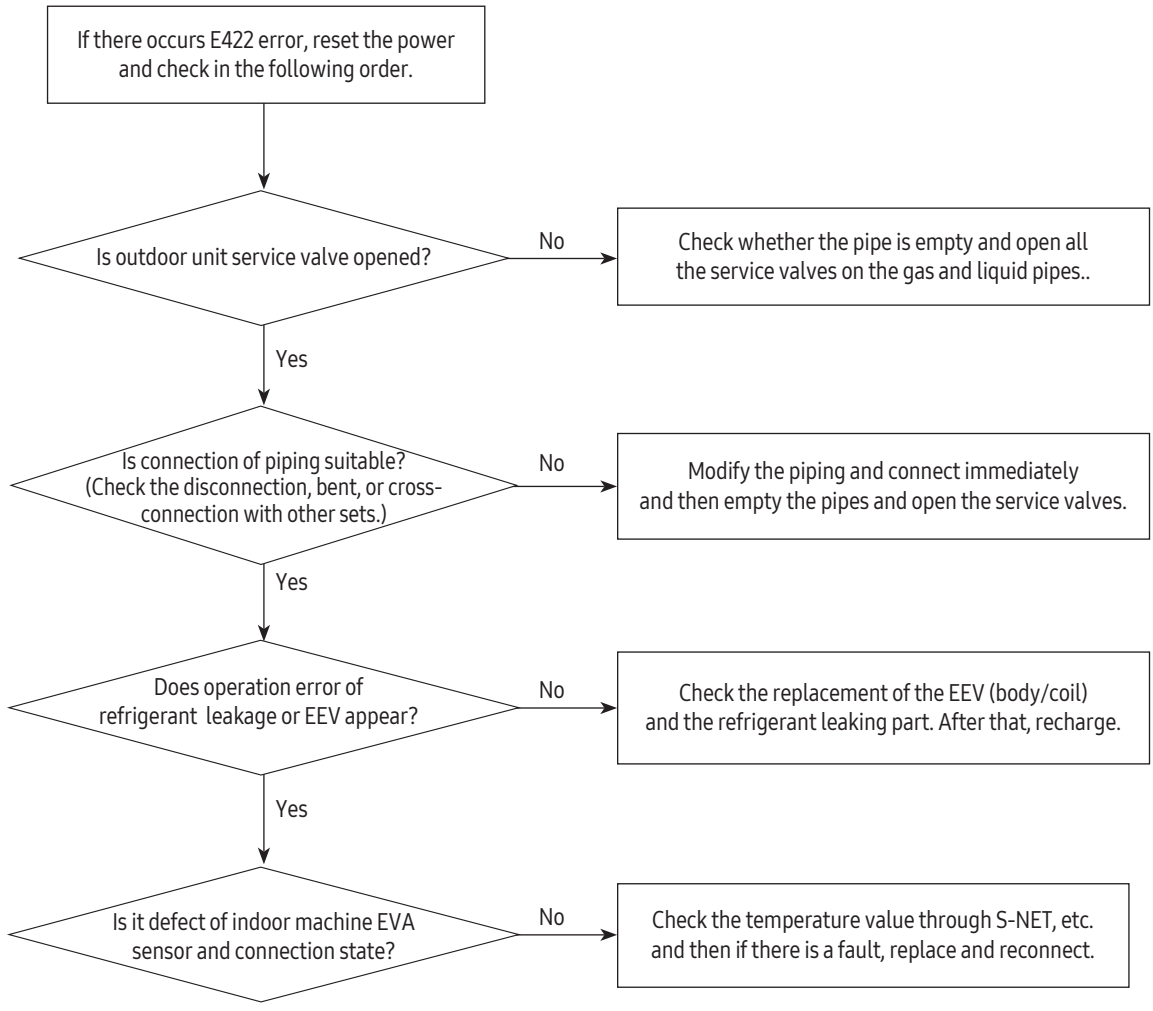







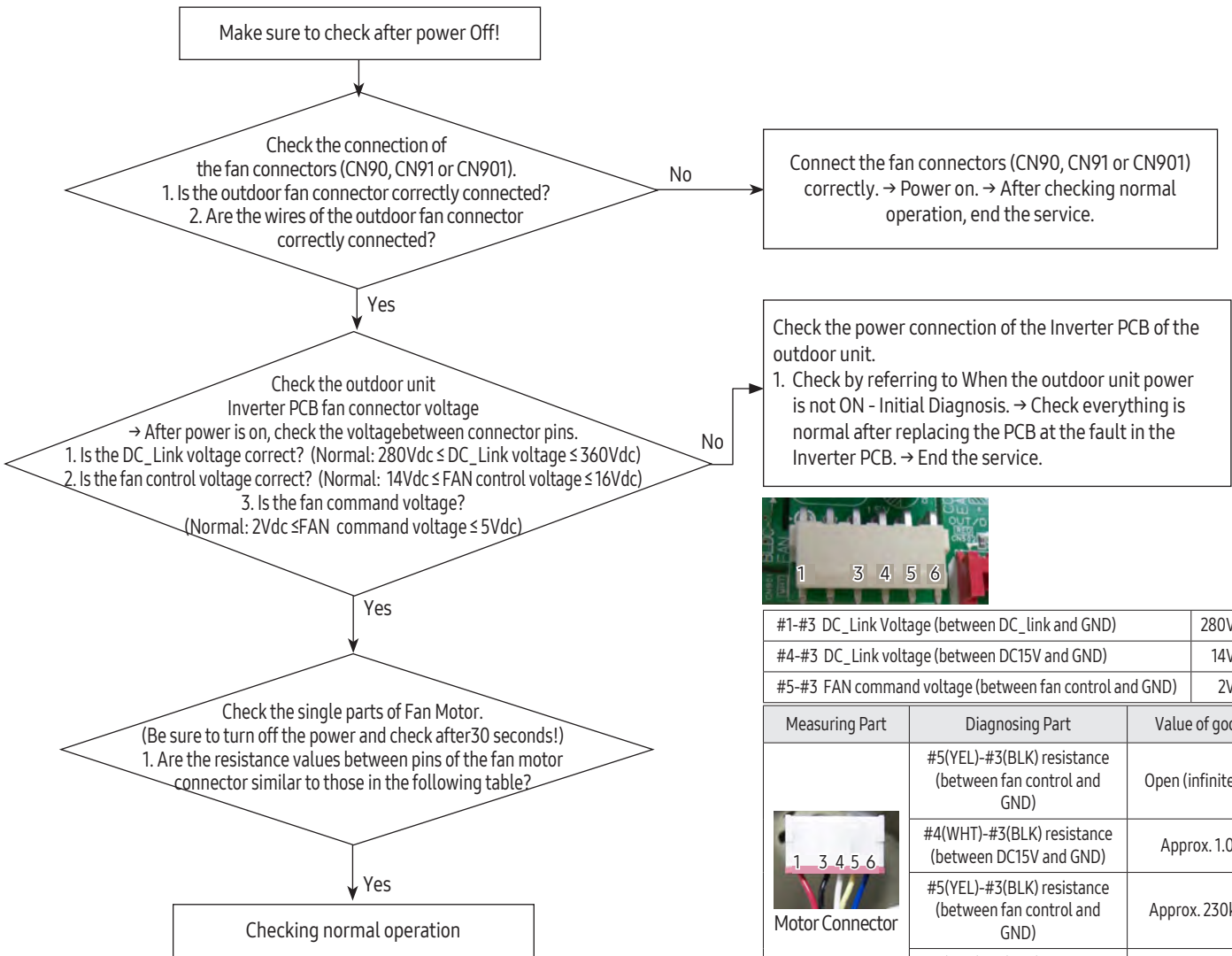



























### 4-4-14. Outdoor unit Fan error (Error Code : E458, E475)

Display	Outdoor Unit display		E458, E475															
	Wired remote Control, Wind Free RAC		E458, E475															
	Duct, 1way Cassette			4way Cassette, 4way Cassette(600x600)				MAX4		Console				360 Cassette				
	Duct Blue Red		or ⌚	or 🌀	or 📊	⌚	⚠️	⌚	📊	⌚	⌚	TURBO	...	🌀	⌚	⚠️	●	BLUE ●
	1way Blue Yellow																	
X	X	●	●	●	X	●	●	●	●	●	●	●	●	●	●	X	X	
Judgment method	Refer to checking method, as shown below.																	
Symptom																		



- ※ At least 30 seconds after power is OFF, attach/detach the fan motor connector!  
→ Threatened to cause secondary damage to the motor and the PCB.
- ※ Check the Inverter PCB or Fan Motor single parts and only if there is a fault, replace!
- ※ Do not replace the Main PCB of the outdoor unit relating to the fault in the Fan Motor!  
→ If the error is indicated on 7-segment of the Main PCB of the outdoor unit, the Main PCB of the outdoor unit has no fault.  
→ In case of a control problem, it is possible to solve with S/W update.

### 4-4-15. Compressor starting error / rotation error (Error Code : E461, E467)

Display	Outdoor Unit display		E461, E467															
	Wired remote Control, Wind Free RAC		E461, E467															
	Duct, 1way Cassette		4way Cassette, 4way Cassette(600x600)				MAX4			Console				360 Cassette				
	 Duct Blue Red 1way Blue Yellow		 or 	 or 	 or 													BLUE 
	X	X				X											X	
Judgment method	Refer to checking method, as shown below.																	
Symptom																		

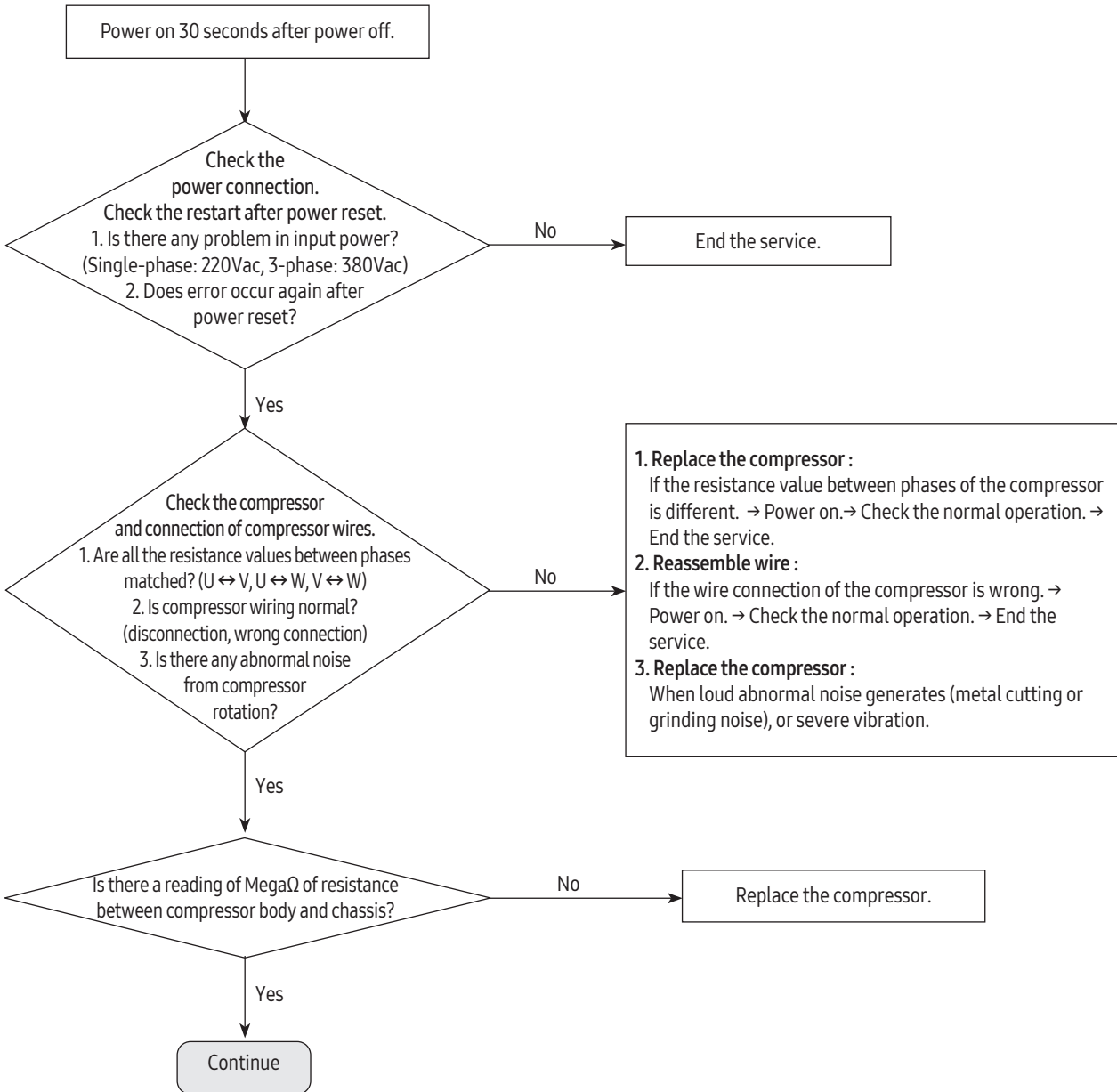



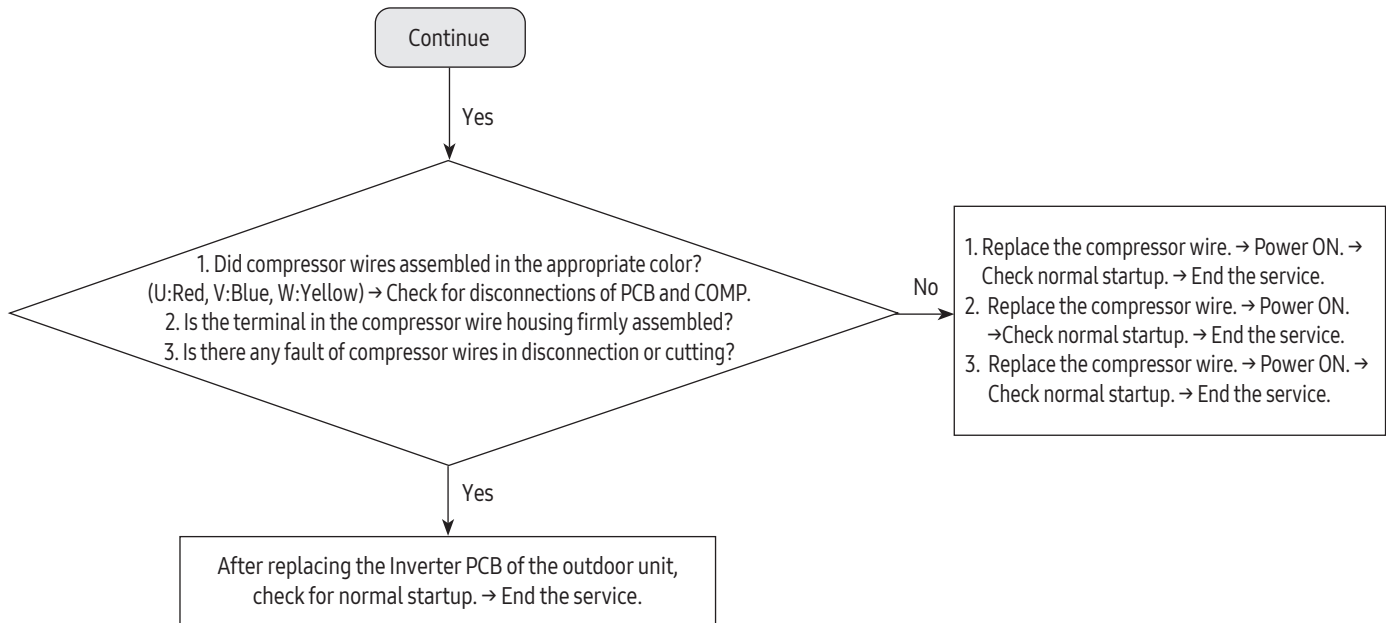













### Compressor starting error / rotation error (Error Code : E461, E467) (Cont.)



- ※ E461, E467 Error-related, EMI / outdoor unit Main / Indoor unit Main PCB do not replace!  
→ This error is related to the compressor and Inverter PCB. (Not related to the above PCB)
- ※ Ensure that the service valve is open!  
→ When the service valve is closed, the defects may be caused by differential pressure when starting the compressor.

**4-4-16. Full current error / PFC over-current error (Error Code : E462, E484)**

Display	Outdoor Unit display		E462, E484														
	Wired remote Control, Wind Free RAC		E462, E484														
	Duct, 1way Cassette			4way Cassette, 4way Cassette(600x600)					MAX4			Console				360 Cassette	
	 Duct Blue Red 1way Blue Yellow		 or  or 	   	   	   	BLUE ●										
	X	X	●	●	●	X	●	●	●	●	●	●	●	●	●	●	X
Judgment method	Refer to checking method, as shown below.																
Symptom																	

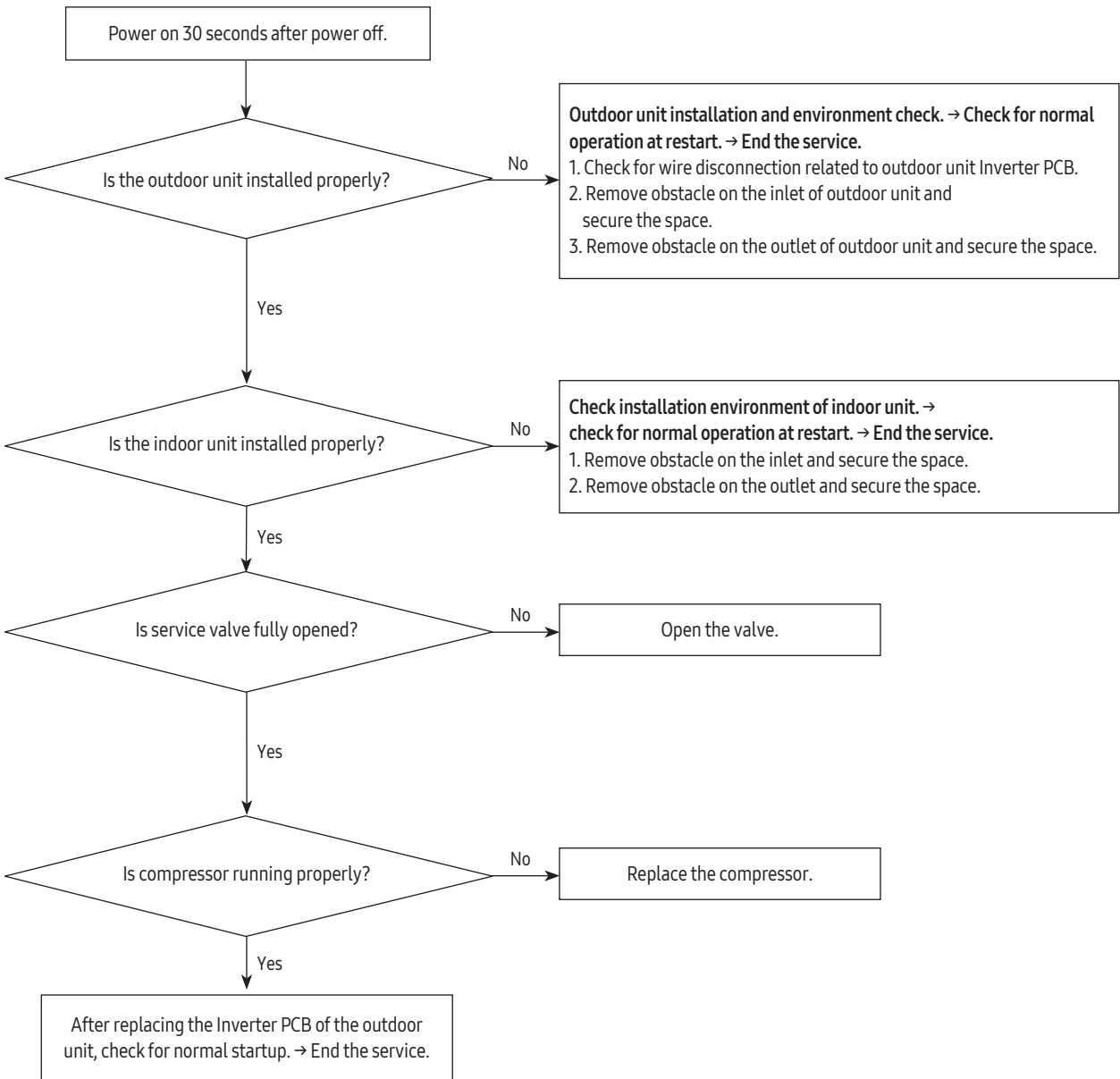



**IPM (Over Current) error (Error Code : E464) (Cont.)**

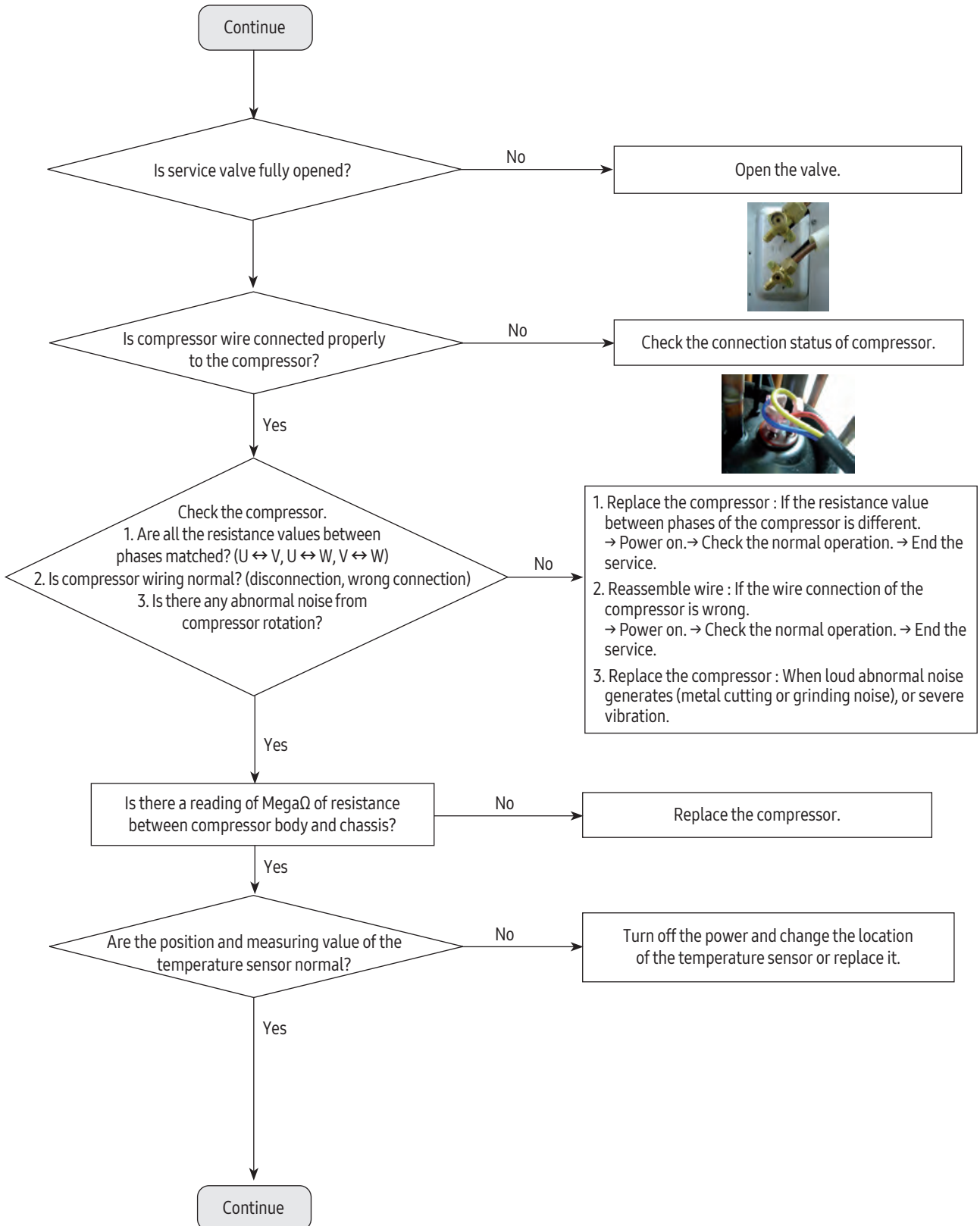

### IPM (Over Current) error (Error Code : E464) (Cont.)

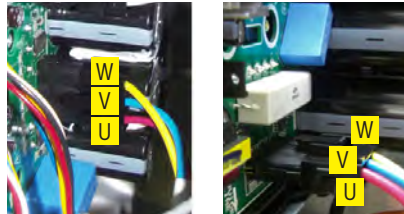
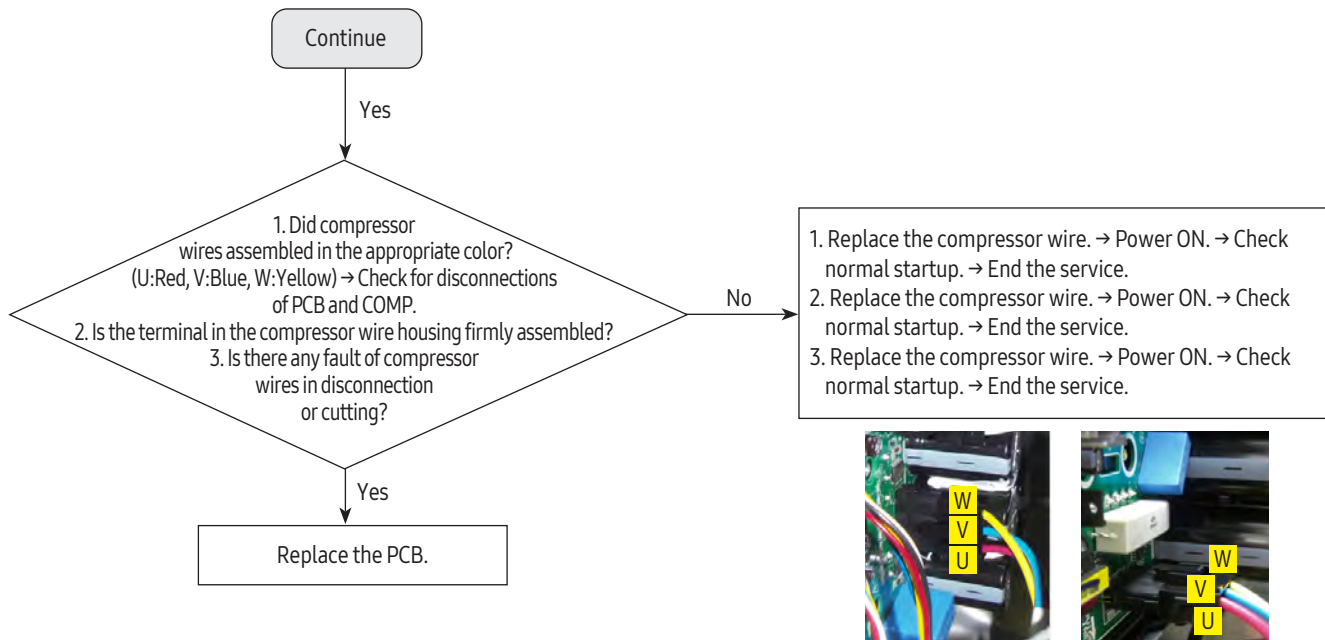

- ※ E46 Error-related, EMI / outdoor unit Main / Indoor unit Main PCB do not replace!  
→ This error is related to the Inverter PCB. (Not related to the above PCB)
- ※ Ensure that the service valve is open!  
→ When the service valve is closed, the defects may be caused by differential pressure when starting the compressor.

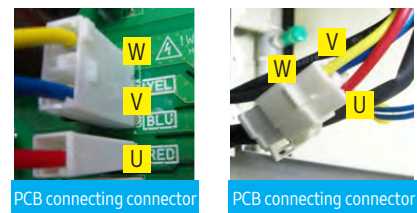

**4-4-18. DC LINK over-current / low-voltage error (Error Code : E466)  
H/W DC\_Link Over Voltage Error (Error Code : E483)  
AC Input Voltage Sensor Error (Error Code : E488)**

Display	Outdoor Unit display		E466, E483, E488																
	Wired remote Control, Wind Free RAC		E466, E483, E488																
	Duct, 1way Cassette					4way Cassette, 4way Cassette(600x600)				MAX4		Console				360 Cassette			
	Duct Blue Red		or ⌚	or 🌀	or 📊	⌚	⚡	⌚	📊	⌚	⌚	TURBO	...	🌀	⌚	⚡	●	BLUE ●	
	1way Blue Yellow																		⌚
X	X	●	●	●	X	●	●	●	●	●	●	●	●	●	●	●	●		
Judgment method																			
Symptom																			

- Test items
  - Check the power connection. / Check the restart after power reset.
    - Is there a fault in input power? (Single-phase : 220Vac, 3-phase : 380Vac)
    - Does error occur again at operation after power is reset?
  - Check the connection of the power, and check whether the jointed power connection exists.
    - After having installed several units, please check that communication wires are not interchanged with piping.
  - Check the reactor and its connecting wires.
  - Check the fuses of EMI PBA.
  - Check the Terminal Block and Power Terminal Box and the wire assembly.

2. Check procedure

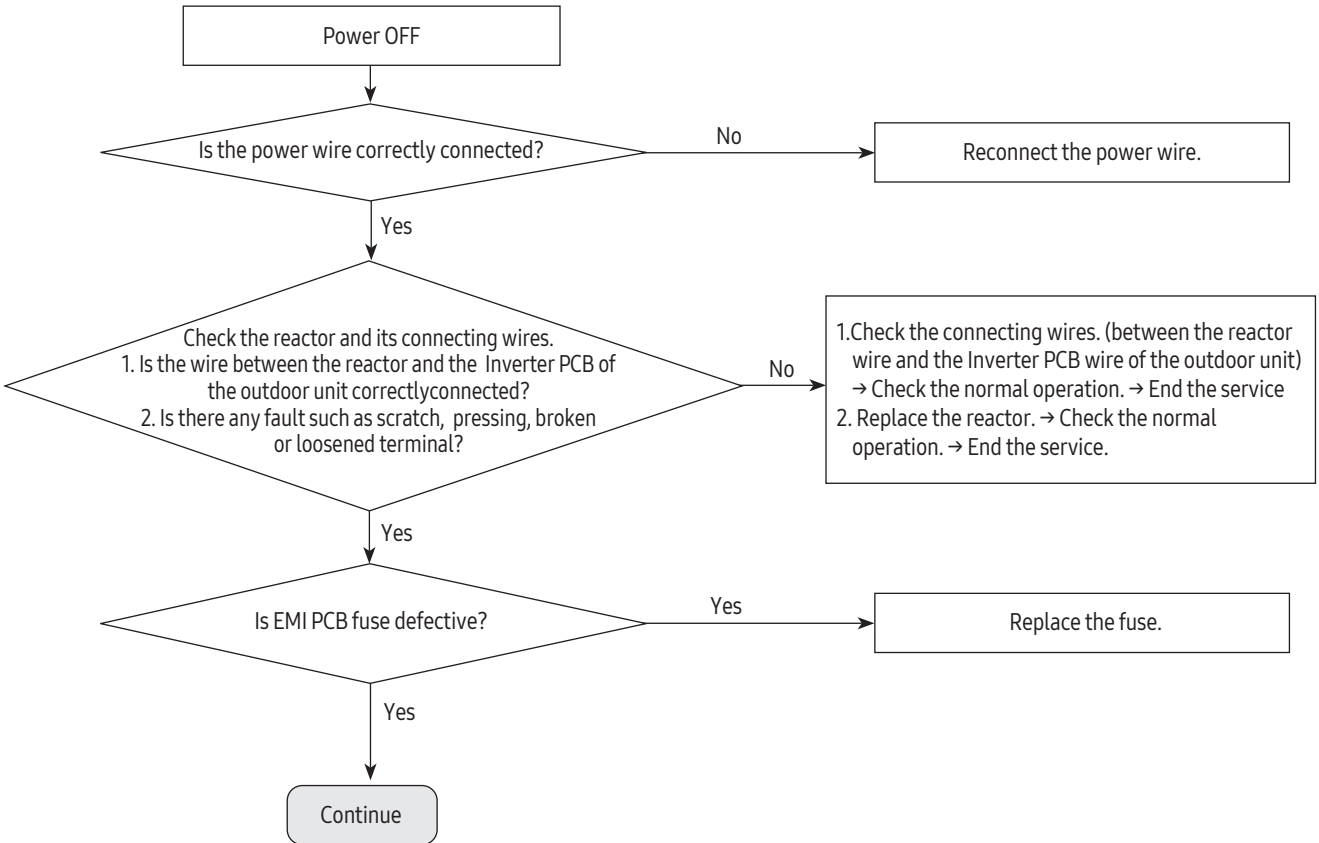





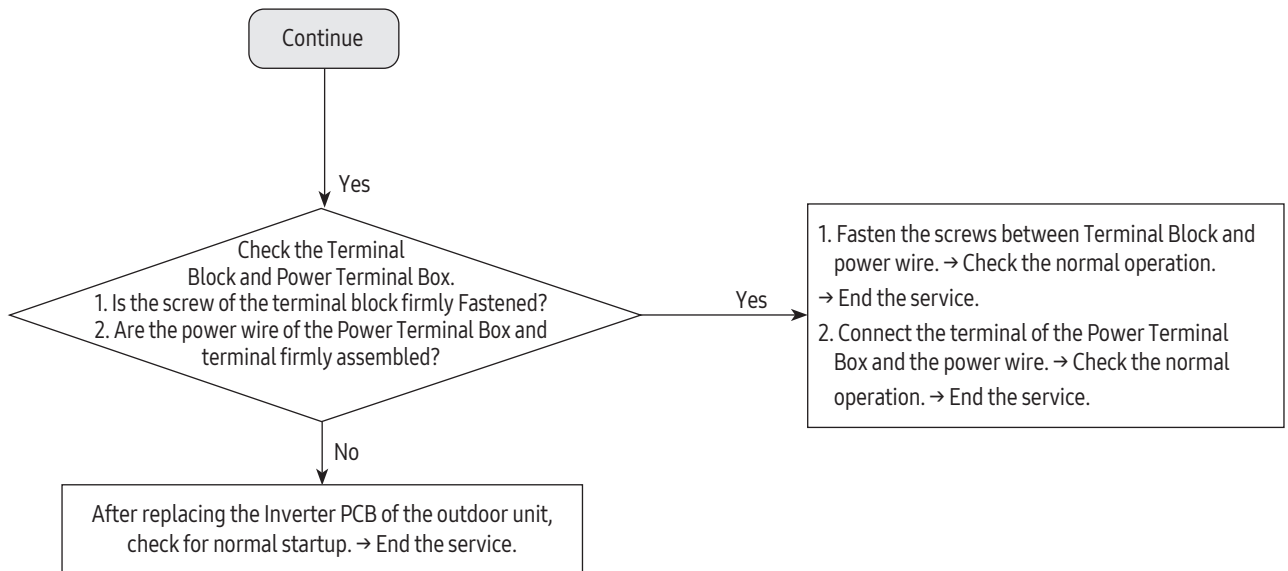































**4-4-18. DC LINK over-current / low-voltage error (Error Code : E466)  
H/W DC\_Link Over Voltage Error (Error Code : E483)  
AC Input Voltage Sensor Error (Error Code : E488)(Cont.)**



### 4-4-19. Gas leakage error (Error Code : E554)

Display	Outdoor Unit display		E554																
	Wired remote Control, Wind Free RAC		E554																
	Duct, 1way Cassette			4way Cassette, 4way Cassette(600x600)				MAX4			Console				360 Cassette				
	 Duct Blue Red 1way Blue Yellow		 or 	 or 	 or 													BLUE 	
	X	X				X													X
Judgment method																			
Symtom																			

1. Test items

- 1) Check the power connection. / Check the restart after power reset.
  - Is there a fault in input power? (Single-phase : 220Vac, 3-phase : 380Vac)
  - Does error occur again at operation after power is reset?
- 2) Check the compressor and the state of compressor wire assembling.
- 3) Check the outdoor unit installation environment.
  - Check for disconnection of the wires regarding the Inverter PCB of the outdoor unit and check the installation environment.
  - At the site where several units were installed at the same time, check whether communication wire and pipes have been wrongly connected!

2. Check procedure

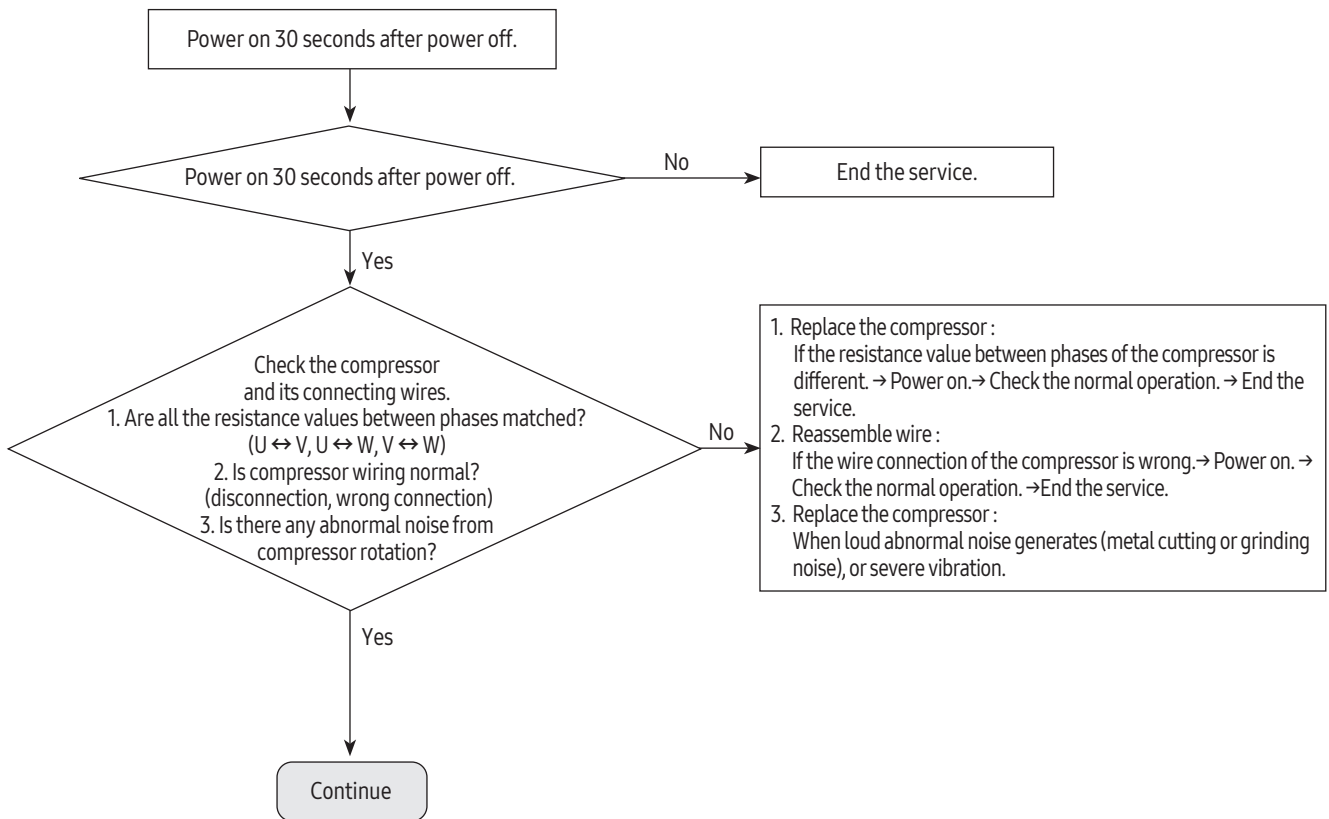

### Gas leakage error (Error Code : E554) (Cont.)

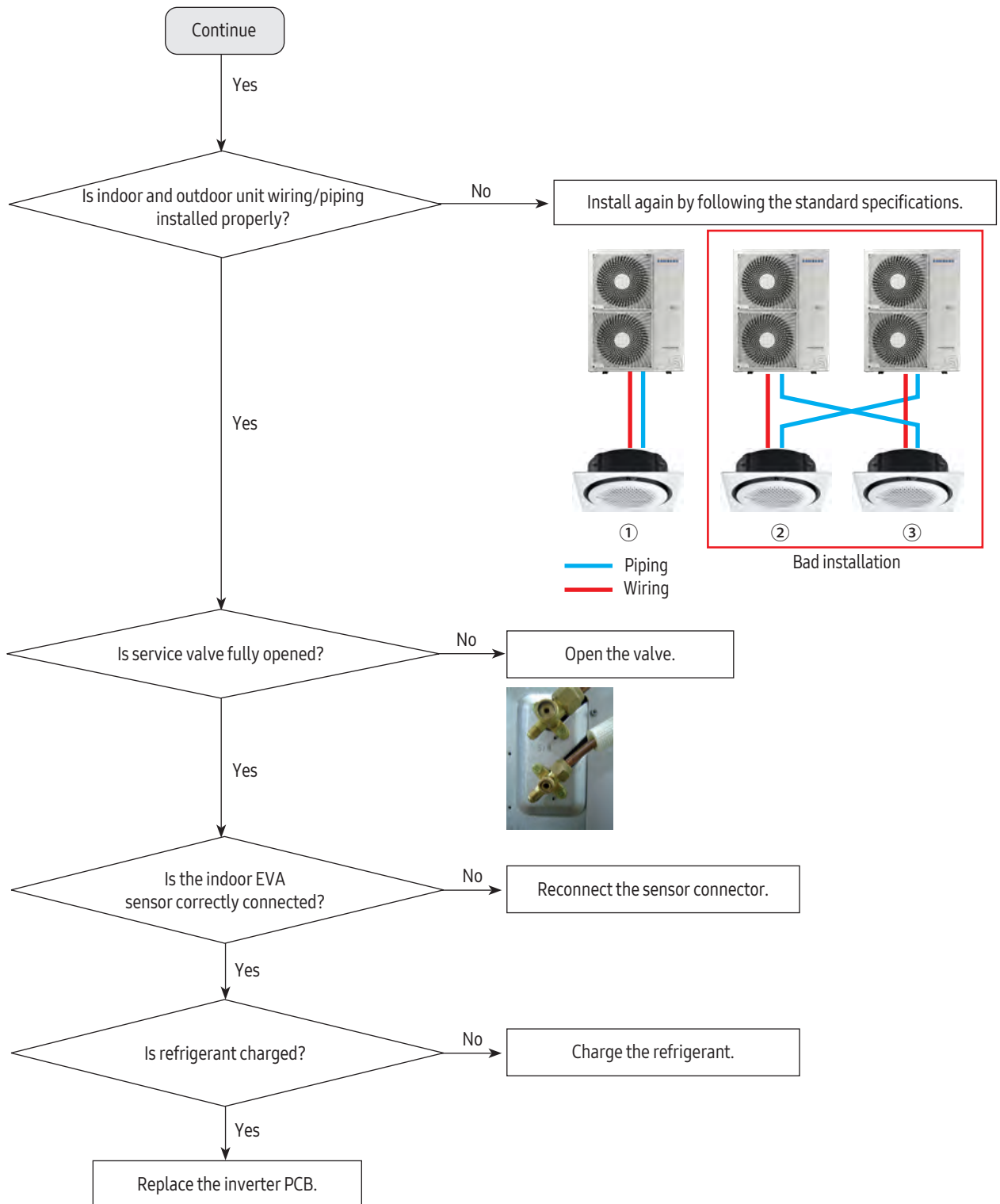

#### 4-4-20. Others

1. EEPROM option error (E163) : Reset the options.
2. Temperature fuse error : E198
  - If the Terminal Box temperature rise fuse is disconnected, replace the PCB.
  - Check the wiring connector of temperature fuse.
3. Current sensor error : Upload EEPROM to the Main PCB of the outdoor unit.
  - After checking for normal operation of PCB, replace the inverter PCB.
4. Compressor Vlimit error : E465
  - If the compressor is abnormally run, replace the compressor and then ensure that it works normally.
  - If the compressor is normally run, check the assembling between the heatproof plate and the Inverter PCB and then if there is no abnormality, replace the Inverter PCB.
5. DC link voltage sensor error : E469
  - Error occurs when DC LINK value is not normal (DC LINK VOLTAGE: 280~320V)
  - Check the value of DC link when error occurs and check the reactor disconnection
6. EEPROM read/write error : E470
  - Error occurs when there is no EEPROM data in the set.
  - Check the model name and insert EEPROM for corresponding model or load the EEPROM data.
7. Input current sensor error : E485
  - Detect the input sensor while the set is in stop status to check if there's any problem.
  - When error occurs, turn on/off the power for number of time and if same error occurs while the power is off, replace the Inverter PCB.
8. OTP error : E471
  - Upload EEPROM to the Main PCB of the outdoor unit.
9. Capacity inconsistency error : E556
  - Check the model name between the outdoor and indoor unit and re-enter the option code to the indoor unit.
10. 3-phase power wire disconnection : E424
  - Check for disconnection of the 3-phase (open) power wire, and check the disconnected EMI PBA fuse.
11. Outdoor unit freezing detection (at the stop of the compressor) : E403  
 Outdoor overload protection control (at the stop of the compressor) : E404
  - Check whether the fan and the motor operate normally.
  - Check the operation of EEV.
  - Check the temperature sensor of the indoor unit heat exchanger.
  - Check the indoor unit inlet blockage.
12. Outdoor unit compressor discharging temperature protection control : E416
  - Check for lack of refrigerant.
  - Check the blockage of the solenoid valve.
  - Check the malfunction of the exhaust temperature sensor.
  - Check the EEV.
13. Error of impossibility to operate Heating at outdoor temperature exceeding 30°C : E440  
 Error of impossibility to operate cooling at outdoor temperature of -5°C or under : E441
  - It is not the error code in the product and it is a specification to protect the product by limiting the temperature scope of use.
  - Use by referring to the temperature scope of use on the product manual, etc.

## Others (Cont.)

14. OLP overHeating and compressor stop : E463
  - Check the opening of the sub valve.
  - Check the amount of the cooling water.
  - Check the OLP sensor.
15. Current sensor error : E468
  - Check the EEPROM data.
  - Check the PCB operation.
16. IPM (IGBT Module) or PFCM temperature sensor error : E474  
 IPM overheat error for outdoor unit inverter compressor : E500
  - Check whether IPM is correctly assembled on the heatproof plate.
  - Check whether the inlet is blockage.
  - If there is a defect, replace the IPM.
17. How to check Booster Fan
  - 1) In case of do not not operate 1 Booster Fan  
 Action method : Remove the Booster Fan connector wire and cross-assembling the another Booster Fan wire and then horizontally or intermediate or swing operate.

Type ① : When the existing Booster Fan does not operate, replace the Booster Fan.

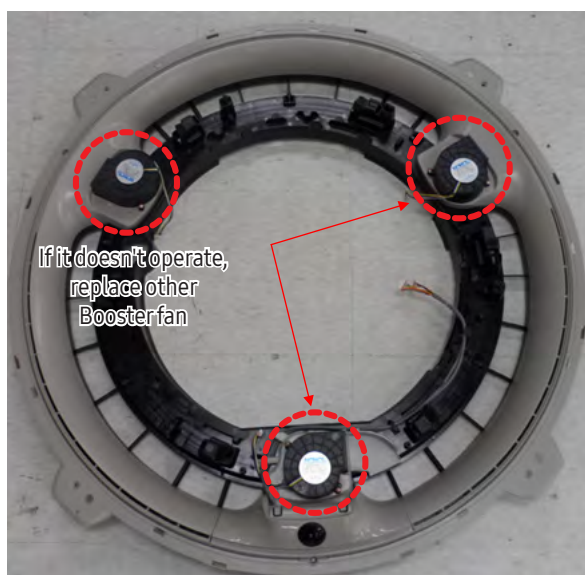

Type ② : If type ① is not defective, Booster Fan Wire 4 (Blue Wire), 3 (Black Wire) pin voltage :  
 When it is more than 2.7V, replace the PCB.



- PIN No.1 : VCC (YELLOW/+)
- PIN No.2 : SIGNAL (WHITE)
- PIN No.3 : GROUND (BLACK/-)
- PIN No.4 : PWM (BLUE)

## Others (Cont.)

2) In case of do not operate 3 Booster Fan (all Fan)

Action method : horizontally or intermediate or swing set up.

Type ①: Booster Fan Wire 1 (Yellow Wire), 3 (Black Wire) pin voltage :  
When it is less than DC12V, replace the PCB.



PIN No.1: VCC (YELLOW/+)  
PIN No.2: SIGNAL (WHITE)  
PIN No.3: GROUND (BLACK/-)  
PIN No.4: PWM (BLUE)

Type ②: If type ① is not defective, Booster Fan Wire 4 (Blue Wire), 3 (Black Wire) pin voltage :  
When it is more than 2.7V, replace the PCB.



PIN No.1: VCC (YELLOW/+)  
PIN No.2: SIGNAL (WHITE)  
PIN No.3: GROUND (BLACK/-)  
PIN No.4: PWM (BLUE)

Type ③: If type ② is not defective, Booster Fan Wire 2 (White Wire), 3 (Black Wire) pin voltage :  
When it is approximately 5V, replace the PCB.



PIN No.1: VCC (YELLOW/+)  
PIN No.2: SIGNAL (WHITE)  
PIN No.3: GROUND (BLACK/-)  
PIN No.4: PWM (BLUE)

## 5. PCB Diagram and Parts List

### 5-1. Indoor Unit Main PBA

■ 1way Cassette, 4way Cassette, 4way Cassette(600x600) :  
AC\*\*\*BN1DCH, AC\*\*\*BN4DCH, AC\*\*\*BNNDCH

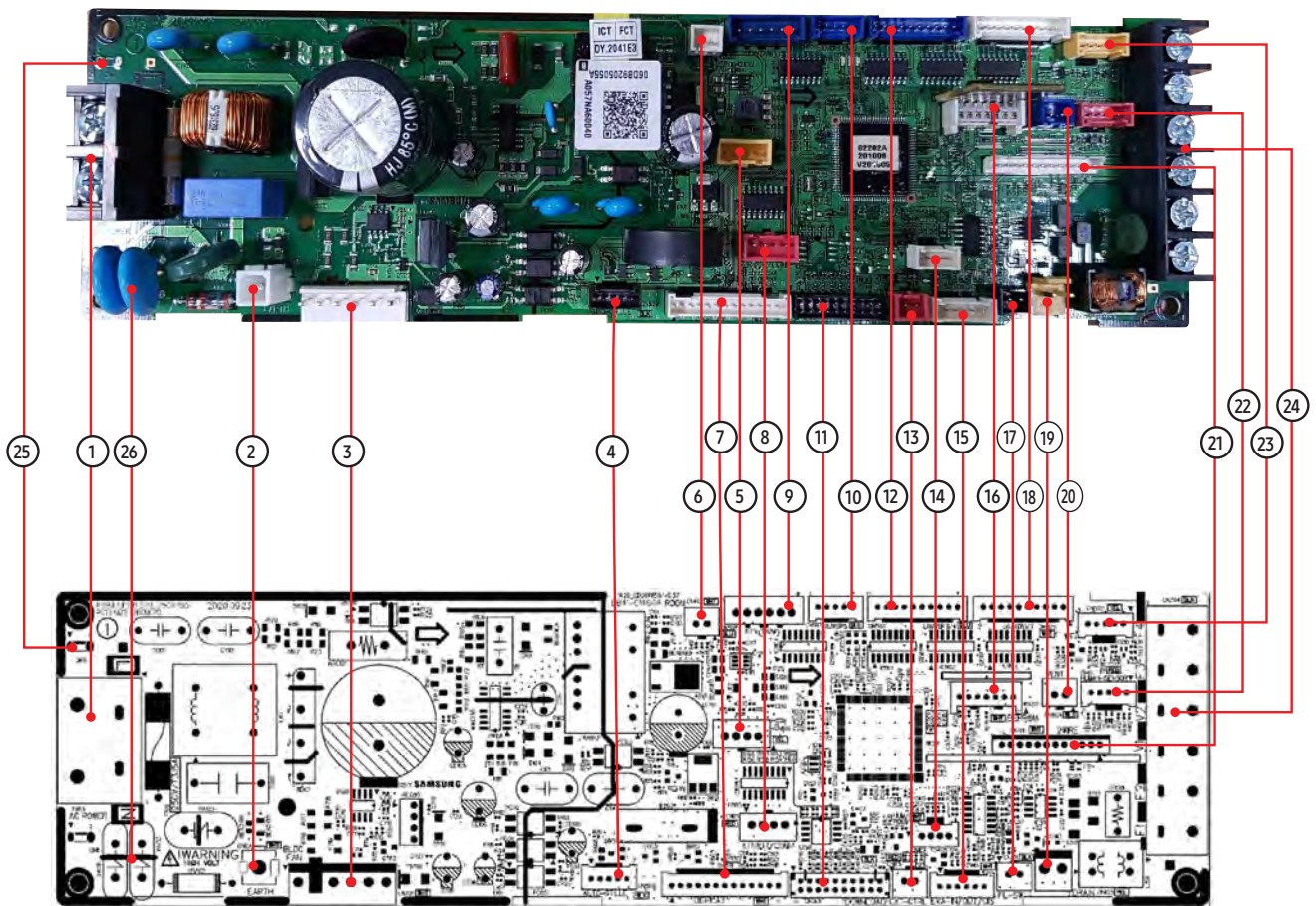

This Document can not be used without Samsung's authorization.

<p>① <b>TB101-AC POWER</b> #1:AC POWER(L) #2:AC POWER(N)</p>	<p>② <b>CN101-EARTH</b> #1: EARTH</p>	<p>③ <b>CN701-BLDC MOTOR</b> #1: DC310V #3: GND #4: DC15V #5: FAN RPM #6: RPM FEEDBACK</p>	<p>④ <b>CN809-AUTO GRILLE</b> #1: DC12V #4: REMOCON SIGNAL #5: GND</p>
<p>⑤ <b>CN801-SPI</b> #1: GND #2: GND #3: SPI SIGNAL (DC12V)</p>	<p>⑥ <b>CN412-ROOM SENSOR</b> #1 : ROOM SENSOR #2: GND</p>	<p>⑦ <b>CN501-DISPLAY</b> #1: DC12V #2: LED_0 #3: LED_1 #4: LED_2 #5: LED_3 #6: LED_4 #7: LED_5 #8: REMOCON SIGNAL OUTPUT #9 : AUTO SWITCH #10:REMOCON SIGNAL INPUT #11: GND #12: DC5V #13: GND</p>	<p>⑧ <b>CN81-COMP/ERROR MONITOR</b> #1: DC12V #2: ERROR OUT (GND) #3: DC12V #4: COMP/OPER. OUT (GND)</p>
<p>⑨ <b>CN808-EEV(DVM)</b> #1: WATER_VALVE1 #2: WATER_VALVE2 #3: NC #4: NC #5~#6: DC12V</p>	<p>⑩ <b>CN807-LOUVER5</b> #1 : DC12V #2~#5: LOUVER SIGNAL</p>	<p>⑪ <b>CN301-DOWNLOAD</b></p>	<p>⑫ <b>CN806-LOUVER3/4</b> #1 : DC12V #2~#5: LOUVER SIGNAL #6 : DC12V #7~#10: LOUVER SIGNAL</p>
<p>⑬ <b>CN83-EXT CTRL</b> #1: GND #2: EXTERNAL CONTROL SIGNAL</p>	<p>⑭ <b>CN414-HUMIDITY SENSOR</b> #1 DC5V #2: GND #3: THERMISTOR SENSOR #4: HUMIDITY SENSOR</p>	<p>⑮ <b>CN413:THERMISTOR</b> #1: EVA-IN SENSOR #2: GND #3: EVA-OUT SENSOR #4: GND #5: DISCHARGE SENSOR #6: GND</p>	<p>⑯ <b>CN201-EEPROM</b> #1: GND #3: DC5V #4: EEPROM_SELECT #5: EEPROM_SO #6: EEPROM_SI #7: EEPROM_CLK</p>
<p>⑰ <b>CN411-FLOAT SWITCH</b> #1: F/S SIGNAL #2: GND</p>	<p>⑱ <b>CN805-LOUVER1/2</b> #1 : DC12V #2~#5: LOUVER SIGNAL</p>	<p>⑲ <b>CN103-DRAIN PUMP</b> #1: DRAIN PUMP(DC12V) #2: GND</p>	<p>⑳ <b>CN804-VENTILATOR</b> #1: DC12V #2: VENT SIGNAL OUTPUT(GND)</p>
<p>㉑ <b>CN311-2WIRED REMOCON</b></p>	<p>㉒ <b>CN401-HUMAN SENSOR</b> #1: DC12V #2:MAIN-HUMAN SENSOR COMM(TXD) #3:MAIN-HUMAN SENSOR COMM(TXD) #4: GND</p>	<p>㉓ <b>CN302-WiFi</b> #1: TXD #2: RXD #3: DC5V #4: GND #5: DC12V</p>	<p>㉔ <b>TE04-COMMUNICATION</b> #1: COM1(F1) #2: COM1(F2) #3: V1(DC12V) #4: V2(GND) #5: COM2(F3) #6: COM2(F4)</p>
<p>㉕ <b>CN110-AC POWER</b> #1:AC POWER(L)</p>	<p>㉖ <b>CN111-AC POWER</b> #1:AC POWER(N)</p>		



■ 360 Cassette : AC\*\*\*BN6DCH

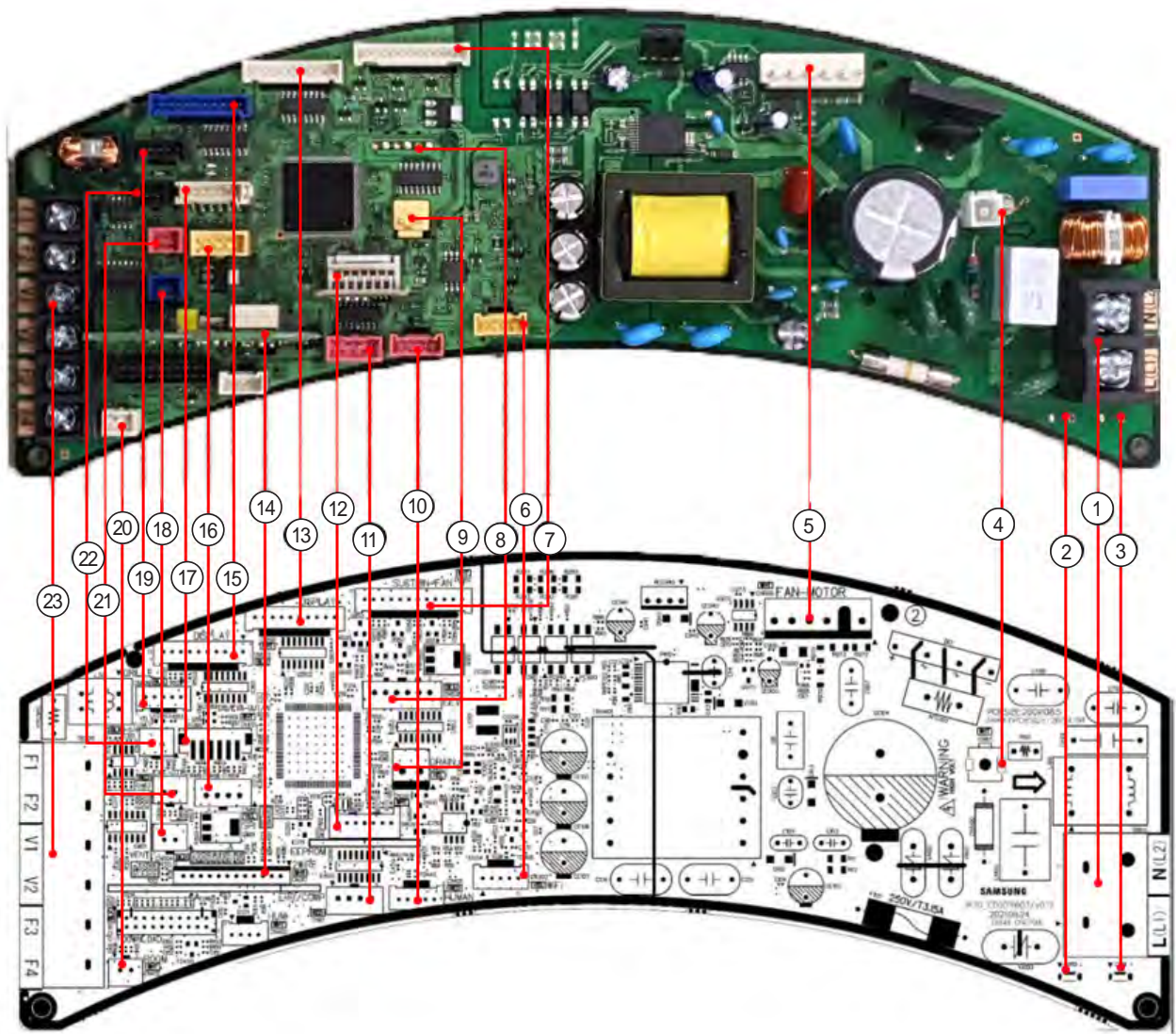

This Document can not be used without Samsung's authorization.

<p>① <b>TB100-AC POWER</b> #1 : AC POWER(L) #2 : AC POWER(N)</p>	<p>② <b>CN110-AC POWER</b> #1 : AC POWER(L)</p>	<p>③ <b>CN111-AC POWER</b> #1 : AC POWER(N)</p>	<p>④ <b>CN101-EARTH</b> #1 : GND</p>
<p>⑤ <b>CN900-BLDC MOTOR</b> #1 : DC 310V #3 : GND #4 : DC 15V #5 : FAN RPM #6 : RPM FEEDBACK</p>	<p>⑥ <b>CN302-WIFI</b> #1 : TXD #2 : RXD #3 : DCSV #4 : GND #5 : DC12V</p>	<p>⑦ <b>CN950-SUCTION FAN</b> #1,#5 #9 : DC12V #2 #6 #10 : FAN FEEDBACK #3 #7 #11 : GND #4 #8 #12 : FAN CTRL</p>	<p>⑧ <b>CN808-EEV(DVM)</b> #1 : WATER_VALVE1 #2 : WATER_VALVE2 #3 : NC #4 : NC #5~#6 : DC12V</p>
<p>⑨ <b>CN802-DRAIN PUMP</b> #1 : DRAIN PUMP(DC12V) #2 : GND</p>	<p>⑩ <b>CN401- HUMAN SENSOR</b> #1 : DC 12V #2 : MAIN-HUMAN SENSOR COMM(TXD) #3 : MAIN-HUMAN SENSOR COMM(TXD) #4 : GND</p>	<p>⑪ <b>CN81-COMP/ERROR MONITOR</b> #1 : DC 12V #2 : ERROR OUT (GND) #3 : DC 12V #4 : COMP/OPER. OUT (GND)</p>	<p>⑫ <b>CN201-EEPROM</b> #1 : GND #3 : DC 5V #4 : EEPROM_SELECT #5 : EEPROM_SO #6 : EEPROM_SI #7 : EEPROM_CLK</p>
<p>⑬ <b>CN501-DISPLAY</b> #1 : BUZZER1 #2 : BUZZER2 #3 : LED1 #4 : LED2 #5 : LED3 #6 : LED4 #7 : LED5 #8 : LED6 #9 : LED7 #10 : LED8</p>	<p>⑭ <b>CN310-2WIRED REMOCON</b></p>	<p>⑮ <b>CN502-DISPLAY</b> #1 : 12V #2 : LED9 #3 : LED10 #4 : LED11 #5 : LED12 #6 : LED13 #7 : REMOCON SIGNAL OUTPUT #8 : REMOCON SIGNAL INPUT #9 : GND #10 : DV5V</p>	<p>⑯ <b>CN810-SPI</b> #1 : GND #2 : GND #3 : SPI SIGNAL (DC12V)</p>
<p>⑰ <b>CN413-THERMISTOR</b> #1 : EVA-IN SENSOR #2 : GND #3 : EVA-OUT SENSOR #4 : GND #5 : DISCHARGE SENSOR #6 : GND</p>	<p>⑱ <b>CN804-VENTILATOR</b> #1 : DC 12V #2 : VENTILATOR SIGNAL OUTPUT(GND)</p>	<p>⑲ <b>CN809-AUTO GRILLE</b> #1 : DC 12V #4 : REMOCON SIGNAL #5 : GND</p>	<p>⑳ <b>CN412-ROOM SENSOR</b> #1 : ROOM SENSOR #2 : GND</p>
<p>㉑ <b>CN83-EXT CTRL</b> #1 : GND #2 : EXTERNAL CONTROL SIGNAL</p>	<p>㉒ <b>CN411-FLOAT SWITCH</b> #1 : F/S SIGNAL #2 : GND</p>	<p>㉓ <b>TB300-COMMUNICATNION</b> #1 : COM1(F1) #2 : COM2(F2) #3 : V1(DC12V) #4 : V2(GND) #5 : COM2(F3) #6 : COM2(F4)</p>	

■ Home duct : AC\*\*\*BNLDCH

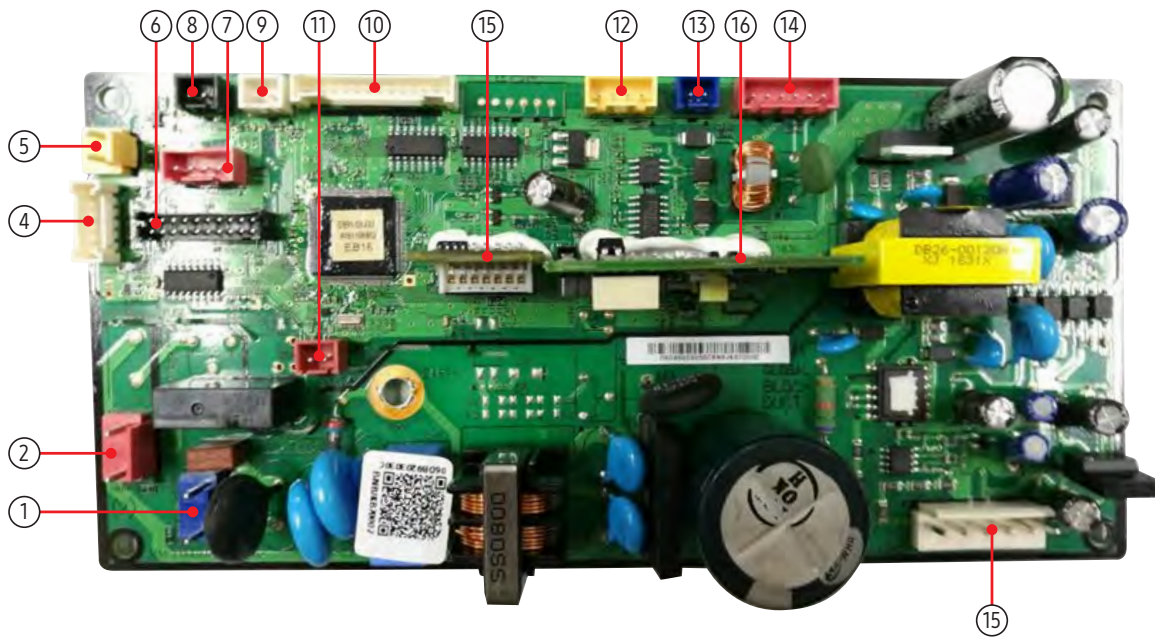

This Document can not be used without Samsung's authorization.

<p>① <b>CN101-POWER</b>                  #1 : AC POWER(L)                  #3 : AC POWER(N)</p>	<p>② <b>CN702- HOT COIL</b>                  #1 : AC POWER(N)                  #3 : HOT COIL POWER (L)</p>	<p>③ <b>CN413 - EVA IN/OUT/DIS</b>                  #1 : EVA IN SENSOR                  #2 : GND                  #3 : EVA OUT SENSOR                  #4 : GND                  #5 : DISCHARGE SENSOR                  #6 : GND</p>	<p>④ <b>CN103 - DRAIN PUMP</b>                  #1 : DRAIN PUMP (DC12V)                  #2 : GND</p>
<p>⑤ <b>CN301 - SW DOWNLOAD</b></p>	<p>⑥ <b>CN81 - ERROR/COMP CHECK</b>                  #1 : DC12V                  #2 : ERROR OUT (GND)                  #3 : DC12V                  #4 : COMP/OPER. OUT (GND)</p>	<p>⑦ <b>CN411 - FLOAT SWITCH</b>                  #1 : FLOAT SWITCH SIGNAL                  #2 : GND</p>	<p>⑧ <b>CN411 - FLOAT SWITCH</b>                  #1 : ROOM SENSOR                  #2 : GND</p>
<p>⑨ <b>CN501 - DISPLAY</b>                  #1 : DC12V                  #2 : LED_0                  #3 : LED_1                  #4 : LED_2                  #5 : LED_3                  #6 : LED_4                  #7 : BUZZER OUTPUT                  #8 : REMOCON SIGNAL OUTPUT                  #9 : AUTO SWITCH                  #10 : REMOCON SIGNAL INPUT                  #11 : GND                  #12 : DC5V                  #13 : BUZZER OUTPUT</p>	<p>⑩ <b>CN83 - EXT_CTRL</b>                  #1 : GND                  #2 : EXT-CTRL SIGNAL</p>	<p>⑪ <b>CN801 - SPI</b>                  #1 : GND                  #2 : GND                  #3 : SPI SIGNAL (DC12V)</p>	<p>⑫ <b>CN804 - VENT</b>                  #1 : DC12V                  #2 : VENTILATOR SIGNAL OUTPUT(GND)</p>
<p>⑬ <b>CN302 - COMM</b>                  #1 : COM1(F1)                  #2 : COM1(F2)                  #3 : V1(DC12V)                  #4 : V2(GND)                  #5 : COM2(F3)                  #6 : COM2(F4)</p>	<p>⑭ <b>CN703 - BLDC FAN</b>                  #1 : DC310V                  #3 : GND                  #4 : DC15V                  #5 : FAN RPM                  #6 : RPM EFFDBACK</p>	<p>⑮ <b>CN201 - EEPROM</b>                  #1 : GND                  #3 : DC 5V                  #4 : EEPROM_SHEET                  #5 : EEPROM_SO                  #6 : EEPROM_SI                  #7 : EEPROM_CLK</p>	<p>⑯ <b>CN310 - 2WIRED REMOCON</b>                  #1 : DC12V                  #2 : COM2_PCTRL_MICOM                  #3 : COM2_VCHECK_A                  #4 : COM2_VCHECK_B                  #5 : COM2_MICOM_AD                  #6 : Vcc_PS_OUT(DC5V)                  #7 : COM2_ENABLE                  #8 : COM2_C(COM2_F3)                  #9 : COM2_D(COM2_F4)                  #10 : COM2_Tx                  #11 : COM2_Rx                  #12 : GND</p>

This Document can not be used without Samsung's authorization.

■ Duct S : AC009/012/018/024/030BNHDCH

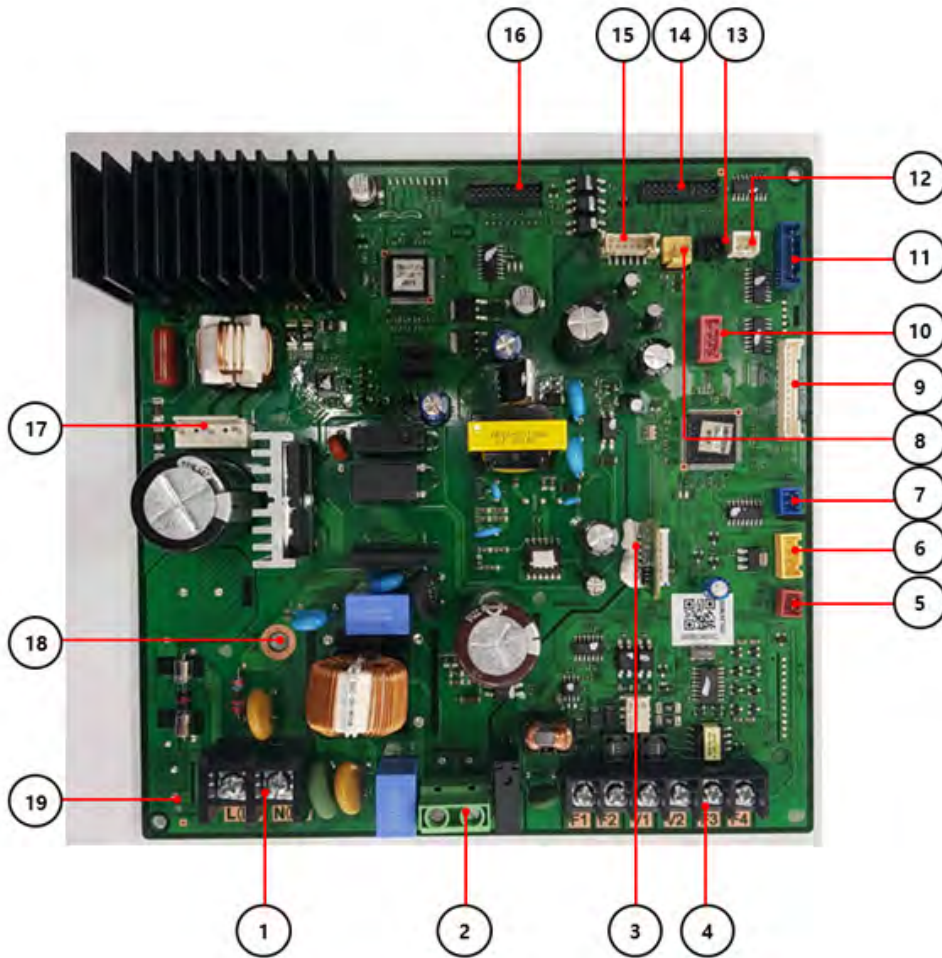

This Document can not be used without Samsung's authorization.

<p>① <b>TE100-AC POWER</b> #1 : AC POWER(L1) #2 : AC POWER(L2)</p>	<p>② <b>CN701-HOT COIL</b> #1 : AC POWER(L2) #2 : AC POWER(L1)</p>	<p>③ <b>CN290-EEPROM</b> #1 : GND #3 : DV 5V #4 : EEPROM_SELECT #5 : EEPROM_SO #6 : EEPROM_SI #7 : EEPROM_CLK</p>	<p>④ <b>CN300-COMMUNICATION</b> #1 : COM1(F1) #2 : COM1(F2) #3 : V1(DC12V) #4 : V2(GND) #5 : COM2(F3) #1 : COM2(F4)</p>
<p>⑤ <b>CN820-EXT CTRL</b> #1 : GND #2 : EXTERNAL CONTROL SIGNAL</p>	<p>⑥ <b>CN825-SPI</b> #1 : GND #2 : GND #3 : SPI SIGNAL(DC 12V)</p>	<p>⑦ <b>CN823-VENTILATOR</b> #1 : DC 12V #2 : VENT SIGNAL OUTPUT(GND)</p>	<p>⑧ <b>CN821-DRAIN PUMP</b> #1 : DRAIN PUMP(DC 12V) #2 : GND</p>
<p>⑨ <b>CN500-DISPLAY</b> #1 : DC 12V #2~#6 : LED OUT(0,1,2,3,4) #7 : BUZZER_1 #8 : REMOCON_SIGN_OUT #9 : AUTO_SW #10 : REMOCON_INT #11 : GND #12 : DV 5V #13 : BUZZER_2</p>	<p>⑩ <b>CN822-COMP/ERROR MONITOR</b> #1 : DC 12V #2 : ERROR OUT(GND) #3 : DC12V #4 : COMP/OPER OUT(GND)</p>	<p>⑪ <b>CN824-EEV</b> #1 : EEV_B_bar_OUT #2 : EEV_A_bar_OUT #3 : EEV_B_OUT #4 : EEV_A_OUT #5 : DC 12V #6 : DC 12V</p>	<p>⑫ <b>CN401-ROOM SENSOR</b> #1 : ROOM SENSOR #2 : GND</p>
<p>⑬ <b>CN400-FLOAT SWITCH</b> #1 : FLOAT SWITCH SIGNAL #2 : GND</p>	<p>⑭ <b>CN200-MAIN DOWNLOAD</b></p>	<p>⑮ <b>CN402-THERMISTOR</b> #1 : EVA-IN SENSOR #2 : GND #3 : EEV_OUT SENSOR #4 : GND #5 : DISCHARGE SENSOR #6 : GND</p>	<p>⑯ <b>CN220-INV DOWNLOAD</b></p>
<p>⑰ <b>CN826-FAN MOTOR</b> #1 : MOTOR-U PHASE #2 : MOTOR-V PHASE #3 : MOTOR-W PHASE</p>	<p>⑱ <b>SH100-EARTH</b> #1 : GND EARTH</p>		

■ Duct S : AC036/042/0480BNHDCH

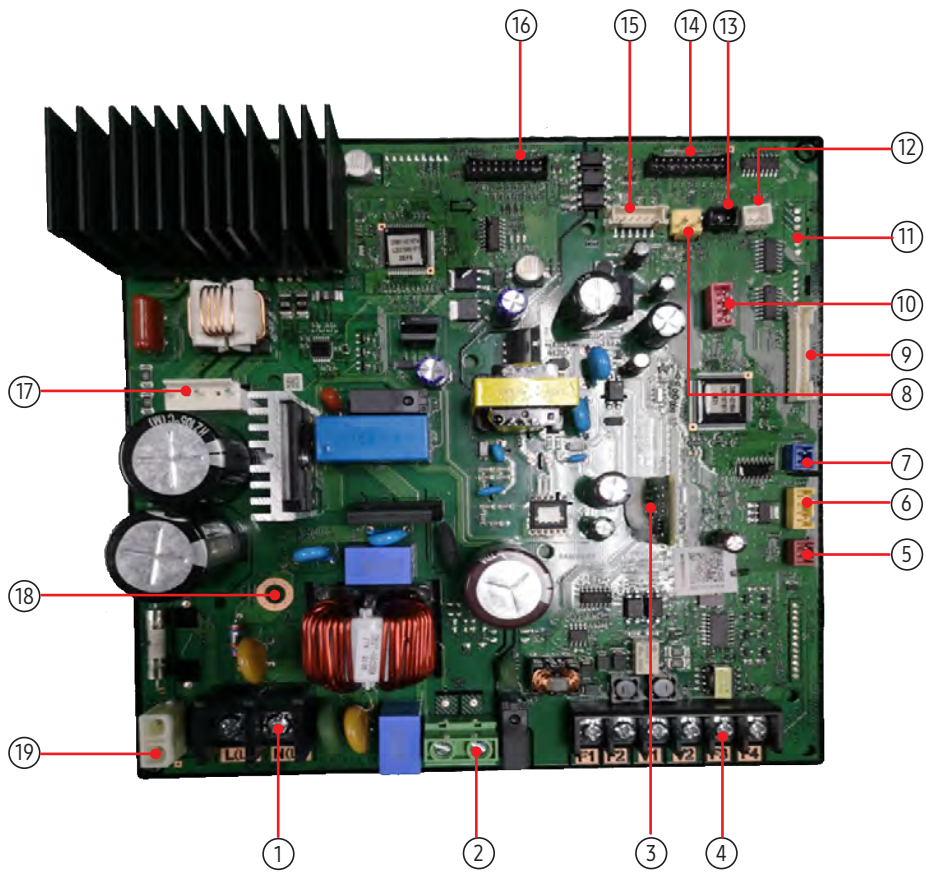

This Document can not be used without Samsung's authorization.

<p>① <b>TE100-AC POWER</b>                  #1 : AC POWER(L1)                  #2 : AC POWER(L2)</p>	<p>② <b>CN701-HOT COIL</b>                  #1 : AC POWER(L2)                  #2 : AC POWER(L1)</p>	<p>③ <b>CN290-EEPROM</b>                  #1 : GND                  #3 : DV 5V                  #4 : EEPROM_SELECT                  #5 : EEPROM_SO                  #6 : EEPROM_SI                  #7 : EEPROM_CLK</p>	<p>④ <b>CN300-COMMUNICATION</b>                  #1 : COM1(F1)                  #2 : COM1(F2)                  #3 : V1(DC12V)                  #4 : V2(GND)                  #5 : COM2(F3)                  #1 : COM2(F4)</p>
<p>⑤ <b>CN820-EXT CTRL</b>                  #1 : GND                  #2 : EXTERNAL CONTROL SIGNAL</p>	<p>⑥ <b>CN825-SPI</b>                  #1 : GND                  #2 : GND                  #3 : SPI SIGNAL(DC 12V)</p>	<p>⑦ <b>CN823-VENTILATOR</b>                  #1 : DC 12V                  #2 : VENT SIGNAL OUTPUT(GND)</p>	<p>⑧ <b>CN821-DRAIN PUMP</b>                  #1 : DRAIN PUMP(DC 12V)                  #2 : GND</p>
<p>⑨ <b>CN500-DISPLAY</b>                  #1 : DC 12V                  #2~#6 : LED OUT(0,1,2,3,4)                  #7 : BUZZER_1                  #8 : REMOCON_SIGN_OUT                  #9 : AUTO_SW                  #10 : REMOCON_INT                  #11 : GND                  #12 : DV 5V                  #13 : BUZZER_2</p>	<p>⑩ <b>CN822-COMP/ERROR MONITOR</b>                  #1 : DC 12V                  #2 : ERROR OUT(GND)                  #3 : DC12V                  #4 : COMP/OPER OUT(GND)</p>	<p>⑪ <b>CN824-EEV</b>                  #1 : EEV_B_bar_OUT                  #2 : EEV_A_bar_OUT                  #3 : EEV_B_OUT                  #4 : EEV_A_OUT                  #5 : DC 12V                  #6 : DC 12V</p>	<p>⑫ <b>CN401-ROOM SENSOR</b>                  #1 : ROOM SENSOR                  #2 : GND</p>
<p>⑬ <b>CN400-FLOAT SWITCH</b>                  #1 : FLOAT SWITCH SIGNAL                  #2 : GND</p>	<p>⑭ <b>CN200-MAIN DOWNLOAD</b></p>	<p>⑮ <b>CN402-THERMISTOR</b>                  #1 : EVA-IN SENSOR                  #2 : GND                  #3 : EEV_OUT SENSOR                  #4 : GND                  #5 : DISCHARGE SENSOR                  #6 : GND</p>	<p>⑯ <b>CN220-INV DOWNLOAD</b></p>
<p>⑰ <b>CN826-FAN MOTOR</b>                  #1 : MOTOR-U PHASE                  #2 : MOTOR-V PHASE                  #3 : MOTOR-W PHASE</p>	<p>⑱ <b>SH100-EARTH</b>                  #1 : GND EARTH</p>	<p>⑲ <b>CN100-REACTOR</b>                  #1 : AC POWER(L1)                  #2 : AC POWER(L1)</p>	



■ Console : AC009/012/018BNJDCH

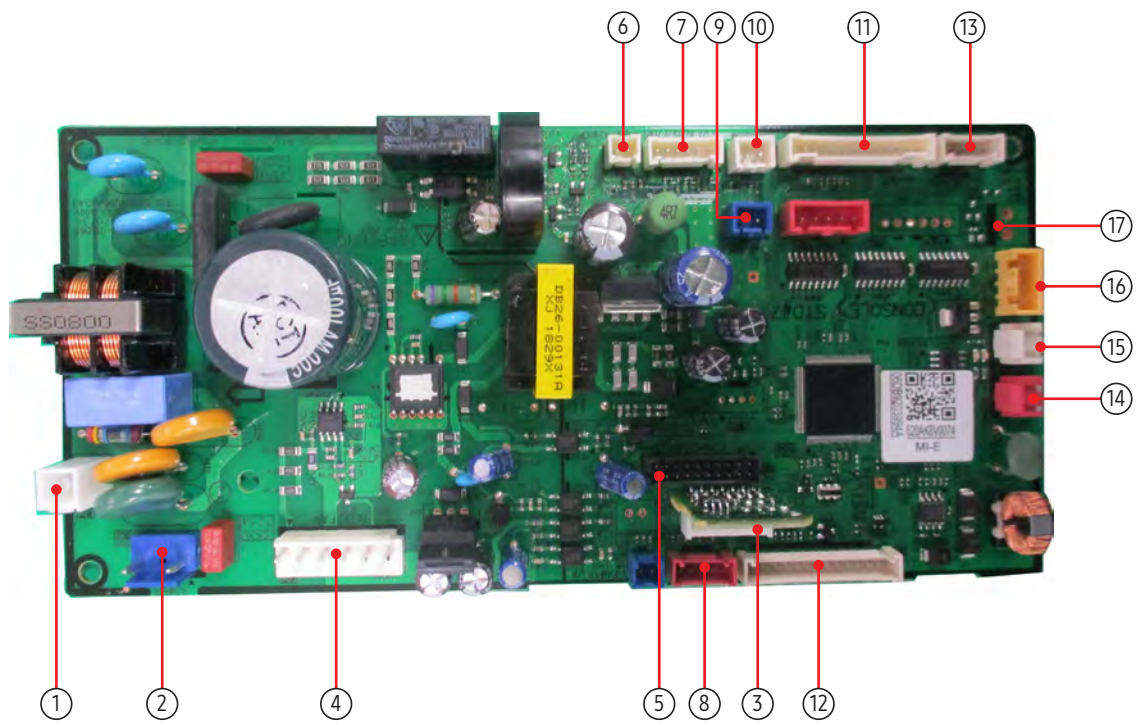

<p>① <b>CN101 : EARTH</b> #1 : EARTH</p>	<p>② <b>CN100 : AC POWER</b> #1 : AC POWER(L) #3 : AC POWER(N)</p>	<p>③ <b>CN201 : EEPROM</b> #1 : GND #3 : DC 5V #4 : EEPROM_SELECT #5 : EEPROM_SO #6 : EEPROM_SI #7 : EEPROM_CLK</p>	<p>④ <b>CN703 : BLDC MOTOR</b> #1 : DC 310V #3 : GND #4 : DC 15V #5 : FAN RPM #6 : RPM FEEDBACK</p>
<p>⑤ <b>CN83 : DOWNLOAD</b></p>	<p>⑥ <b>CN140 : FUSE CHECK</b> #1 : THERMAL FUSE SIGNAL #2 : GND</p>	<p>⑦ <b>CN413 : THERMISTOR</b> #1 : EVA IN SENSOR #2 : GND #3 : EVA OUT SENSOR #4 : GND #5 : DISCHARGE SENSOR #6 : GND</p>	<p>⑧ <b>CN401 : HUMAN SENSING</b> #1 : DC12V #2 : HUMAN SENSING SENSOR COMM (TXD) #3 : HUMAN SENSING SENSOR COMM (M(RXD)) #4 : GND</p>
<p>⑨ <b>CN411 : DAMPER S/W</b> #1 : DAMPER SWITCH SIGNAL #2 : GND</p>	<p>⑩ <b>CN412 : ROOM SENSOR</b> #1 : ROOM SENSOR #2 : GND</p>	<p>⑪ <b>CN301 : DISPLAY</b> #1 : DC12V #2 : LED_0 #3 : LED_1 #4 : LED_2 #5 : LED_3 #6 : LED_4 #7 : DC5V #8 : REMOCON SIGNAL OUTPUT #9 : AUTO SWITCH #10 : REMOCON SIGNAL INPUT #11 : GND #12 : DC5V</p>	<p>⑫ <b>CN501 : 2WIRED REMOCON</b> #1 : COM2_Tx #2 : COM2_Rx #3 : COM2_INVERSE #4 : COM2_ENABLE #5 : EXT_CTRL #6 : COMP_OPER_CHECK #7 : ERROR_CHECK #8 : COM2_PS_OUT(DC5V) #9 : GND #10 : DC12V #11 : COM2_PTCRL_MICOM #12 : COM2_VCCECK_A #13 : COM2_VCCECK_B #14 : COM2_VCCECK_AD</p>
<p>⑬ <b>CN2 : LOUVER</b> #1 : DC12V #2~#5 : LOUVER SIGNAL</p>	<p>⑭ <b>CN31 : COMMUNICATION</b> #1 : COM2(F3) #2 : COM2(F4)</p>	<p>⑮ <b>CN32 : DC 12V</b> #1 : DC12V #2 : GND</p>	<p>⑯ <b>CN801 : SPI</b> #1 : GND #2 : GND #3 : SPI SIGNAL (DC12V)</p>
<p>⑰ <b>CN804 : VENTILATOR</b> #1 : DC12V #2 : VENT SIGNAL OUTPUT(GND)</p>	<p>⑱ <b>CN302 : EEPROM</b> #1 : DC12V #2~#5 : LOUVER SIGNAL</p>		

■ RAC : AC018/024BNADCH

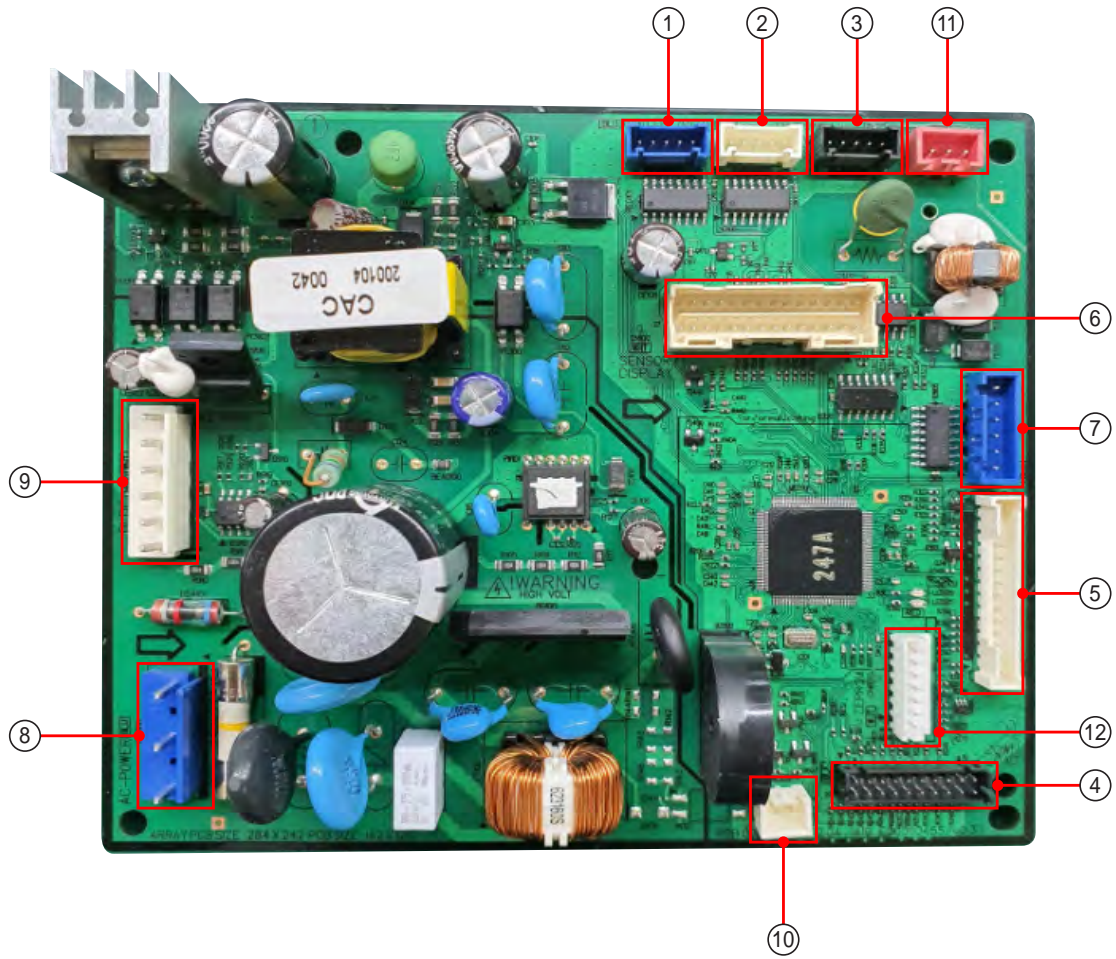

<p>① <b>CN810 : STEP MOTOR (V-Blade)</b></p> <p>#1: 12V                  #2: SIGNAL1                  #3: SIGNAL2                  #4: SIGNAL3                  #5: SIGNAL4</p>	<p>② <b>CN800 : STEP MOTOR (H-BLADE1)</b></p> <p>#1: 12V                  #2: SIGNAL1                  #3: SIGNAL2                  #4: SIGNAL3                  #5: SIGNAL4</p>	<p>③ <b>CN801 : STEP MOTOR (H-BLADE3)</b></p> <p>#1: 12V                  #2: SIGNAL1                  #3: SIGNAL2                  #4: SIGNAL3                  #5: SIGNAL4</p>	<p>④ <b>CN230 : DOWNLOAD</b></p> <p>#1: COM1_RXD                  #2: COM1_TXD                  #3: nTRST                  #4: TDO                  #5: TCK                  #6: TDI                  #7: TMS                  #8: TraceCLK                  #9: SGND                  #10: 5VDC                  #11: 5VDC                  #12: MODE0                  #13: RESET_IN                  #14: Trace3                  #15: AS_PRO_B                  #16: AS_PRO_A                  #17: SGND                  #18: Trace_2                  #19: Trace_1                  #20: Trace_0</p>
<p>⑤ <b>CN340 : WIRED REMOCON</b></p> <p>#1: COM2_Tx                  #2: COM2_Rx                  #3: COM2_INVERSE                  #4: COM2_ENABLE                  #5: EXT_CTRL                  #6: COMP_CHK_OUT                  #7: ERROR_CHK_OUT                  #8: COM2_PS_OUT                  #9: SGND                  #10: 12VDC                  #11: COM2_PCTRL_MICOM                  #12: COM2_VCHECK_A                  #13: COM2_VCHECK_B                  #14: COM2_MICOM_AD</p>	<p>⑥ <b>CN100 : DISPLAY &amp; Thermistor</b></p> <p>#1: LED_DIO                  #2: 5VDC                  #3: LED_CLK(DIS)                  #4: SGND                  #5: LED_STB(DIS)                  #6: H_ROOM_TEMP                  #7: AUTO_SW                  #8: HUM_SENSOR                  #9: SGND                  #10: ROOM_TEMP                  #11: 5VDC                  #12: SGND                  #13: REMOCON_INT(DIS)                  #14: EVA_IN_TEMP                  #15: REMOCON_SIGN_OUT(DIS)                  #16: GND                  #17: NULL                  #18: EVA_OUT_TEMP                  #19: NULL                  #20: SGND                  #21: NULL                  #22: NULL                  #23: 12VDC                  #24: NULL                  #25: MDS_2(DIS_DETECT)                  #26: NULL                  #27: MDS_1(DIS_DETECT)                  #28: 5VDC_1</p>	<p>⑦ <b>CN805 : EEV</b></p> <p>#1: EEV_B_bar_OUT                  #2: EEV_A_bar_OUT                  #3: EEV_B_OUT                  #4: EEV_A_OUT                  #5: 12V                  #6: 12V</p>	
<p>⑨ <b>CN900 : BLDC MOTOR</b></p> <p>#1: 310VDC                  #2: NULL                  #3: P_GND                  #4: 15VDC                  #5: MOTOR SIGNAL                  #6: FEEDBACK SIGNAL</p>	<p>⑩ <b>CN410 : ROOM SENSOR2</b></p> <p>#1: ROOM_TEMP_2                  #2: GND</p>	<p>⑪ <b>CN320 : 485COMM</b></p> <p>#1: F1                  #2: NULL                  #3: F2</p>	<p>⑧ <b>CNP100 : AC POWER</b></p> <p>#1: L                  #2: NULL                  #3: N                  #4: NULL                  #5: GND</p> <p>⑫ <b>CN870 : EEPROM</b></p> <p>#1: SGND                  #2: NULL                  #3: 5VDC                  #4: EEPROM_CS                  #5: EEPROM_MISO                  #6: EEPROM_MOSI                  #7: EEPROM_CLK</p>

■ RAC : AC030/036BNTDCH

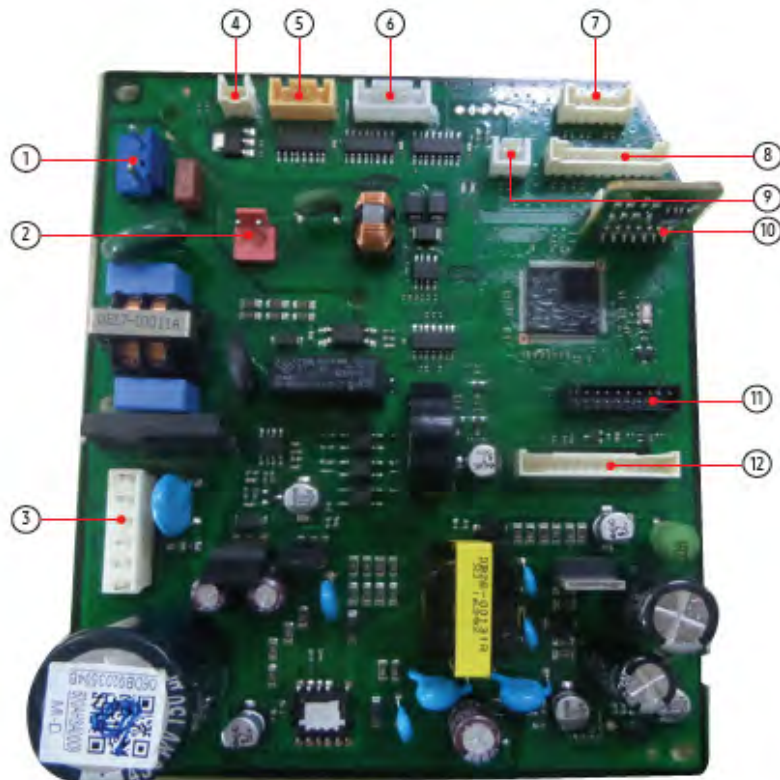

<p>① <b>CNP101-POWER</b>                      #1 : L                      #2 : NOT USED                      #3 : N</p>	<p>② <b>CN303-COM1</b>                      #1~2: COMMUNICATION SIGNAL</p>	<p>③ <b>CN701-BLDC FAN</b>                      #1 : DC 310V                      #2 : NOT USED                      #3 : GND                      #4 : PWM SIGNAL                      #5 : FEEDBACK SIGNAL</p>	<p>④ <b>CN140-FUSE CHECK</b>                      #1 : THERMAL FUSE SIGNAL                      #2 : GND</p>
<p>⑤ <b>CN805-SPI</b>                      #1~2 : GND                      #3 : SPI CONTROL SIGNAL                      #4 : NOT USED</p>	<p>⑥ <b>CN802-STEP UP/DOWN</b>                      #1 : DC 12V                      #2~5 : LOUVER SIGNAL</p>	<p>⑦ <b>CN403-EVA IN/OUT/DIS</b>                      #1 : EVA IN TEMPERATURE SENSOR                      #2 : GND                      #3 : EVA OUT TEMPERATURE SENSOR SIGNAL                      #4 : GND                      #5 : DISCHARGE TEMPERATURE SENSOR SIGNAL                      #6 : GND</p>	<p>⑧ <b>CN501-DISPLAY</b>                      #1 ~3: LED SIGNAL                      #4 : REMOCON SIGNAL                      #5 : GND                      #6 : DC5V                      #7~8 : REMOCON SIGNAL                      #9~11 : NOT USED</p>
<p>⑨ <b>CN401-ROOM</b>                      #1 : OOM TEMPERATURE SENSOR SIGNAL                      #2 : GND</p>	<p>⑩ <b>CN201-EEPROM</b>                      #1 : GND                      #2 : NOT USED                      #3 : DC 5V                      #4~7 : EEPROM SIGNAL</p>	<p>⑪ <b>CN302-DOWNLOAD</b>                      #1~8 : DOWNLOAD SIGNAL                      #9 : GND                      #10~11 : DC 5V                      #12~16 : DOWNLOAD SIGNAL                      #17 : GND                      #18~20 : DOWNLOAD SIGNAL</p>	<p>⑫ <b>CN301-to 2WIRE SUB</b>                      #1~2: COMMUNICATION SIGNAL                      #3~4: SUB PBA SIGNAL                      #5: EXTERNAL CONTROL SIGNAL                      #6: COMP CHECK SIGNAL                      #7: ERROR CHECK SIGNAL                      #8: DC 5V                      #9: GND                      #10: DC 12V                      #11~14: COMMUNICATION SIGNAL</p>

■ MPAH : AC\*\*\*BNZDCH, AC\*\*\*KNZDCH

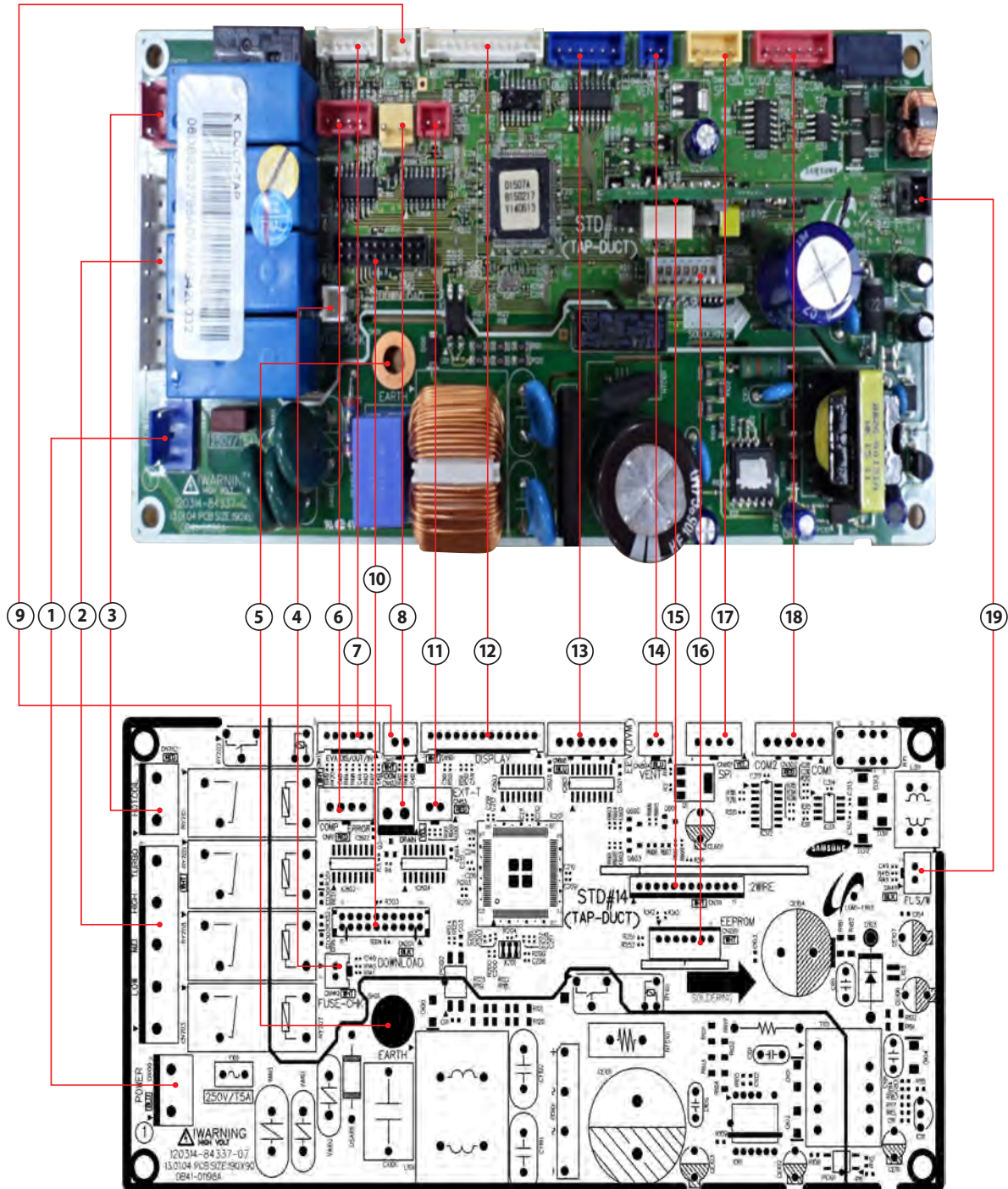

<p>① <b>CN100-AC POWER</b> #1 : L #3 : N</p>	<p>② <b>CN703-MOTOR</b> #1 : N #3,5,7,9 : FAN MOTOR CONTROL SIGNAL</p>	<p>③ <b>CN702-HOT COIL (HEATER)</b> #1 : N #3 : HEATER CONTROL SIGNA</p>	<p>④ <b>CN140-THERMAL FUSE</b> #1 : THERMAL FUSE SIGNAL #2 : GND</p>
<p>⑤ <b>SH01-EARTH</b> #1 : EARTH</p>	<p>⑥ <b>CN81-ERROR/COMP CHECK</b> #1 : DC 12V #2 : ERROR CHECK SIGNAL #3 : DC 12V #4 : COMP CHECK SIGNAL</p>	<p>⑦ <b>CN413-EVA IN/OUT/DIS TEMP. SENSOR</b> #1 : EVI IN TEMP. SENSOR #3 : EVI OUT TEMP. SENSOR #5 : DISCHARGE TEMP. SENSOR #2,4,6 : GND</p>	<p>⑧ <b>CN103-DRAIN PUMP</b> #1 : DRAIN PUMP CONTROL SIGNAL #2 : GND</p>
<p>⑨ <b>CN412-ROOM TEMP. SENSOR</b> #1 : ROOM TEMP. SENSOR #2 : GND</p>	<p>⑩ <b>CN301-DOWNLOAD</b> #1~8 : DOWNLOAD SIGNAL #9 : GND #10~11 : DC 5V #12~16 : DOWNLOAD SIGNAL #17 : GND #18~20 : DOWNLOAD SIGNAL</p>	<p>⑪ <b>CN83-EXTERNAL CONTROL</b> #1 : GND #2 : EXTERNAL CONTROL SIGNAL</p>	<p>⑫ <b>CN501-DISPLAY</b> #1 : DC 12V #3~10,13 : PANEL SIGNAL #11 : GND #12 : DC 5V</p>
<p>⑬ <b>CN808-EEV(DVM)</b> #1~4 : EEV CONTROL SIGNAL #5~6 : DC 12V</p>	<p>⑭ <b>CN804-VENTILATOR</b> #1 : DC 12V #2 : VENTILATOR CONTROL SIGNAL</p>	<p>⑮ <b>CN311-2WIRE SUB</b> #1 : DC 12V #2~5 : COMMUNICATION SIGNAL #6 : DC 5V #7~12 : COMMUNICATION SIGNAL</p>	<p>⑯ <b>CN201-EEPROM</b> #1 : GND #2 : NOT USED #3 : DC 5V #4~7 : EEPROM SIGNAL</p>
<p>⑰ <b>CN801 - SPI</b> #1~2 : GND #3 : SPI CONTROL SIGNAL #4 : NOT USED</p>	<p>⑱ <b>CN302-COMMUNICATION</b> #1~2 : COM1 COMMUNICATION SIGNAL #3 : DC 12V #4 : GND #4~6 : COM2 COMMUNICATION SIGNAL</p>	<p>⑲ <b>CN411-FLOAT SWITCH</b> #1 : FLOAT SWITCH SIGNAL #2 : GND</p>	



## 5-2. Indoor Unit Display PBA

### ■ 4way Cassette, 4way Cassette(600x600) : AC\*\*\*BN4DCH, AC\*\*\*BNNDCH

- ※ The display PBA of 4way cassette is included in the panel.
- ※ The description of the display PBA is based on Windfree Panel.

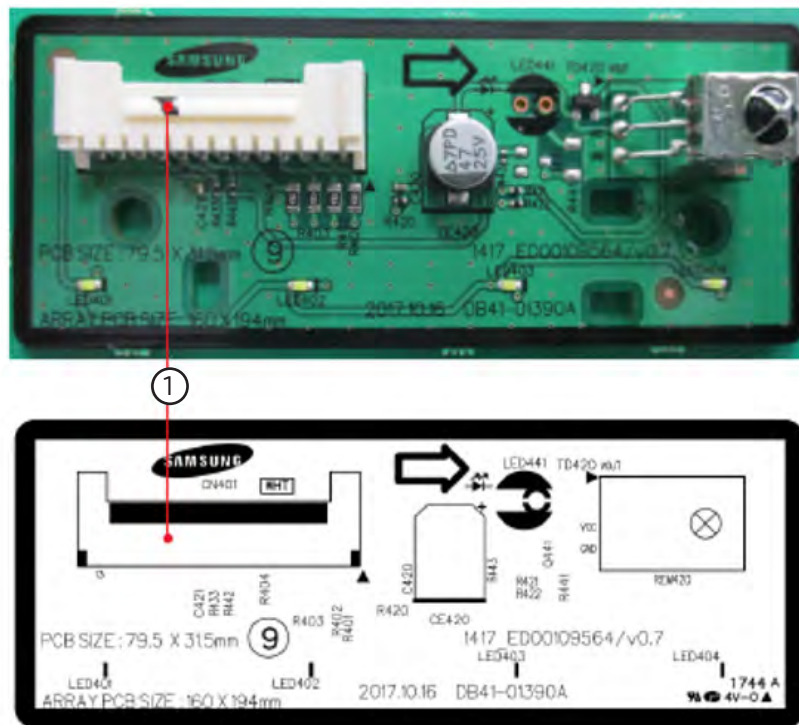

①	CN01 : DISPLAY
#1:	DC12V
#2:	LED_OPERATION
#3:	LED_DEFROST
#4:	LED_TIMER
#5:	-
#6:	LED_FILTER
#7:	-
#8:	REMOCON SIGNAL OUT
#9:	PANEL SELECT
#10:	REMOCON SIGNAL IN
#11:	GND
#12:	DC5V
#13:	-

■ 1way Cassette : AC\*\*\*BN1DCH

- ※ The display PBA of 1way cassette is included in the panel.
- ※ The description of the display PBA is based on Windfree Panel.

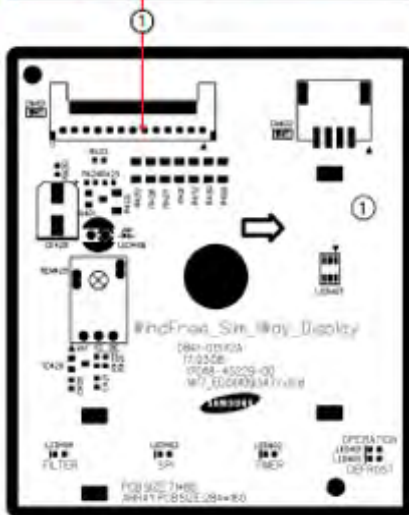

①	CN401-DISPLAY
#1:	DC12V
#2:	LED_0
#3:	LED_1
#4:	LED_2
#5:	LED_3
#6:	LED_4
#7:	-
#8:	REMOCON SIGNAL OUT
#9:	PANEL SELECTION
#10:	REMOCON SIGNAL IN
#11:	GND
#12:	DC5V
#13:	-

■ 360 Cassette : AC\*\*\*BN6DCH

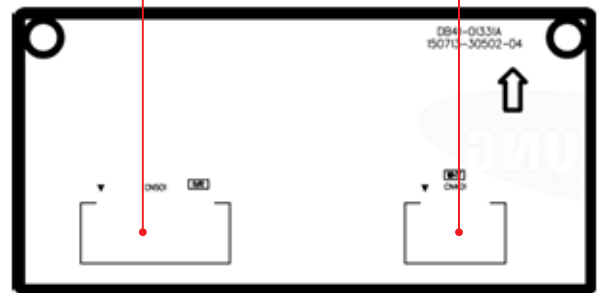
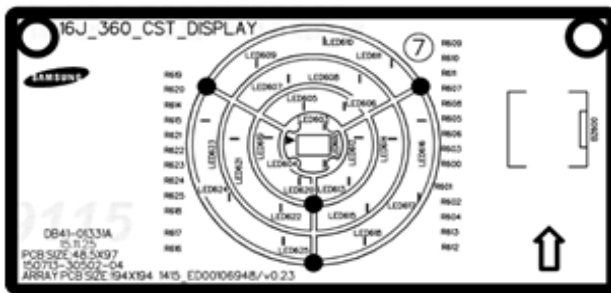

① CN401 - DISPLAY1

- #1 : 12V
- #2 : VISUALIZATION LED\_SECTION2, LAYER2
- #3 : VISUALIZATION LED\_SECTION2, LAYER3
- #4 : VISUALIZATION LED\_SECTION3, LAYER1
- #5 : VISUALIZATION LED\_SECTION3, LAYER2
- #6 : VISUALIZATION LED\_SECTION3, LAYER3

② CN501 - DISPLAY2

- #1 : BUZZER1
- #2 : BUZZER2
- #3 : CENTER 3 COLOR LED - BLUE
- #4 : CENTER 3 COLOR LED - GREEN
- #5 : CENTER 3 COLOR LED - RED
- #6 : CENTER LED - ICE BLUE
- #7 : VISUALIZATION LED\_SECTION1, LAYER1
- #8 : VISUALIZATION LED\_SECTION1, LAYER2
- #9 : VISUALIZATION LED\_SECTION1, LAYER3
- #10 : VISUALIZATION LED\_SECTION2, LAYER1

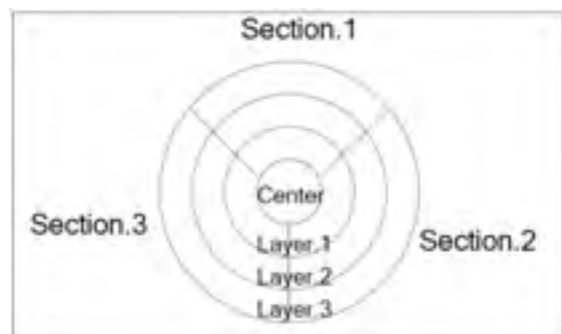

This Document can not be used without Samsung's authorization.

■ Console : AC009/012/018BNJDCH



①	<b>CN101 : DISPLAY</b>
#1	:DC12V
#2~6	: LED
#7	: TOUCH RESET
#8	: REMOCON SIGNAL OUT (NO USE)
#9	: TOUCH SW
#10	: REMOCON SIGNAL IN
#11	: GND
#12	: DC 5V
#13	: NC

## ■ RAC : AC018/024BNADCH

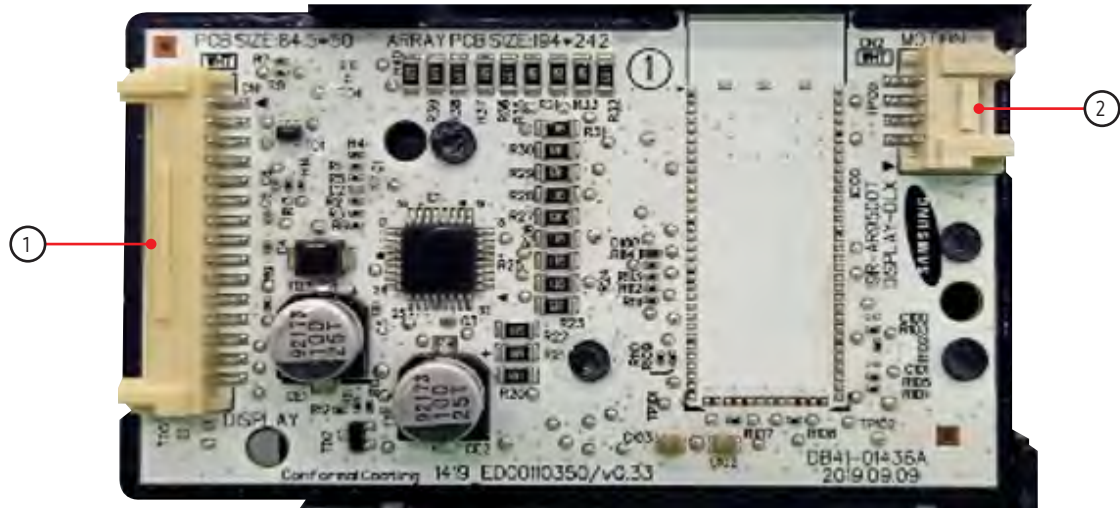

① CN1: DISPLAY	② CN2: DETECT
#1: LED_DIO #2: LED_CLK(DIS) #3: LED_RST(DIS) #4: POWER_SW #5: GND #6: 5V DC #7: REMOCON_INT(DIS) #8: ADDRESS_SW(DIS) #9: MAIN_RX(DIS_WIFI) #10: MAIN_TX(DIS_WIFI) #11: WIFI_CONTROL(DIS_WIFI) #12: 12V DC #13: MSD_2(DIS_DETECT) #14: MDS_1(DIS_DETECT) #15: 5V_1	#1: 5V_1 #2: GND #3: MDS_1 #4: MDS_2

■ RAC : AC030/036BNTDCH

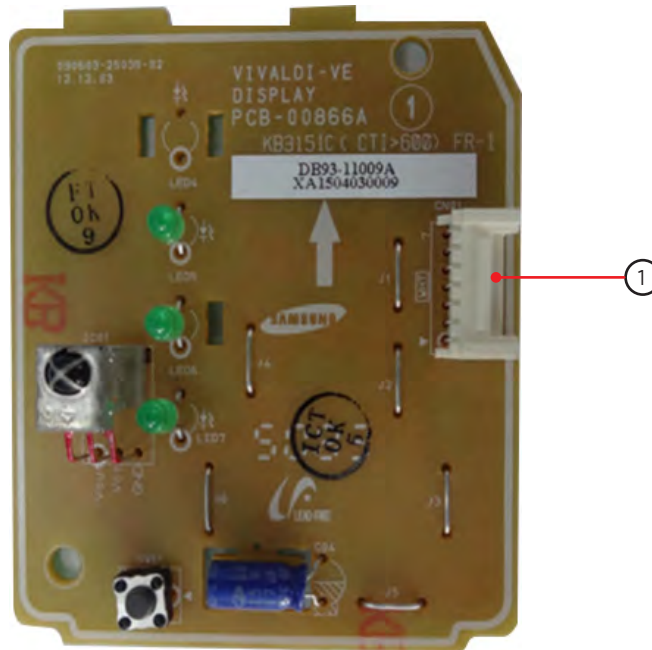

- |   |                        |
|---|------------------------|
| ① | <b>CN101 : DISPLAY</b> |
|   | #1~3 :LED              |
|   | #4: ON/OFF SW          |
|   | #5: GND                |
|   | #6: DC 5V              |
|   | #7: REMOCON SIGNAL IN  |

### 5-3. Indoor Unit Sub PBA

#### ■ 2 wires communication PBA - RAC, Console : AC\*\*\*BNADCH, AC\*\*\*BNTDCH, AC\*\*\*BNJDCH

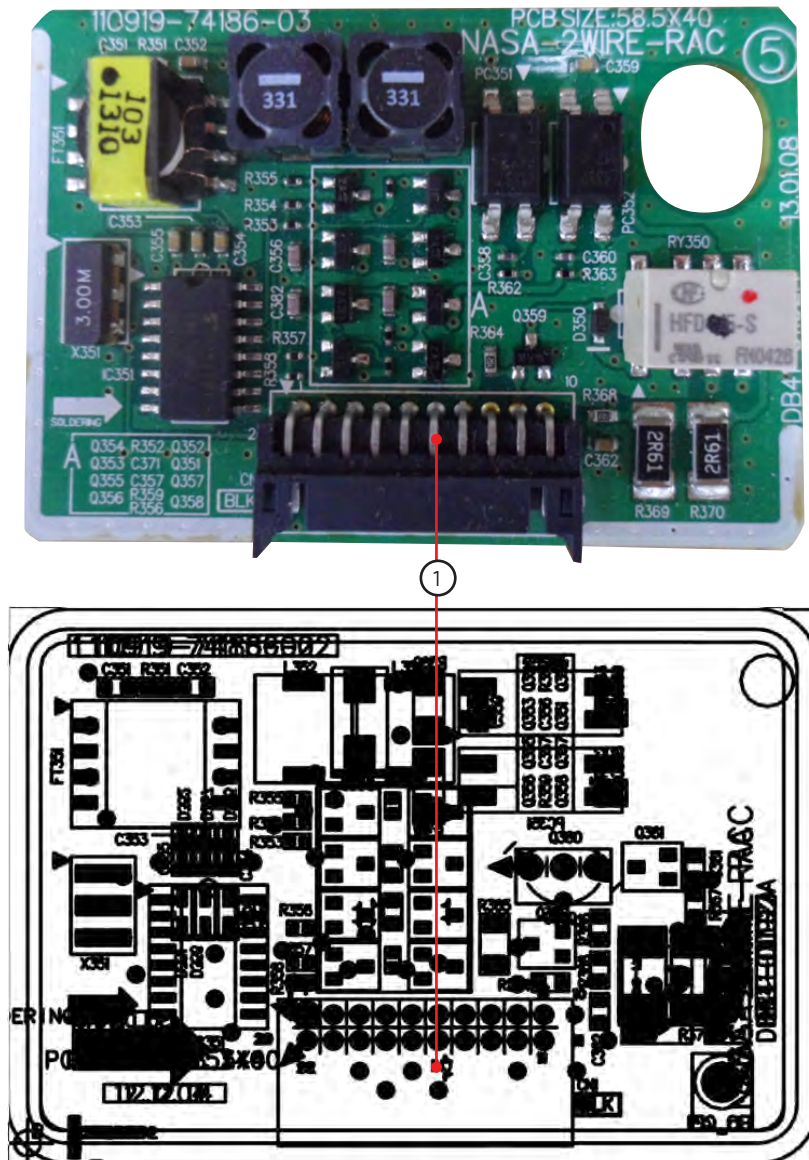

#### ① CN1-2WIRES COMM.

- #1,#2,#19,#20: COMM. SIGNAL
- #3,#18: EXTERNAL CONTROL
- #4,#17: COMP CHECK
- #5,#16: ERROR CHECK
- #6: VCC(DC5V)
- #7,#14: GND
- #8,#13,#15: DC12V
- #9~#12: COMM. SIGNAL

This Document can not be used without Samsung's authorization.

■ Damper Switch PBA - Console : AC\*\*\*BNJDCH

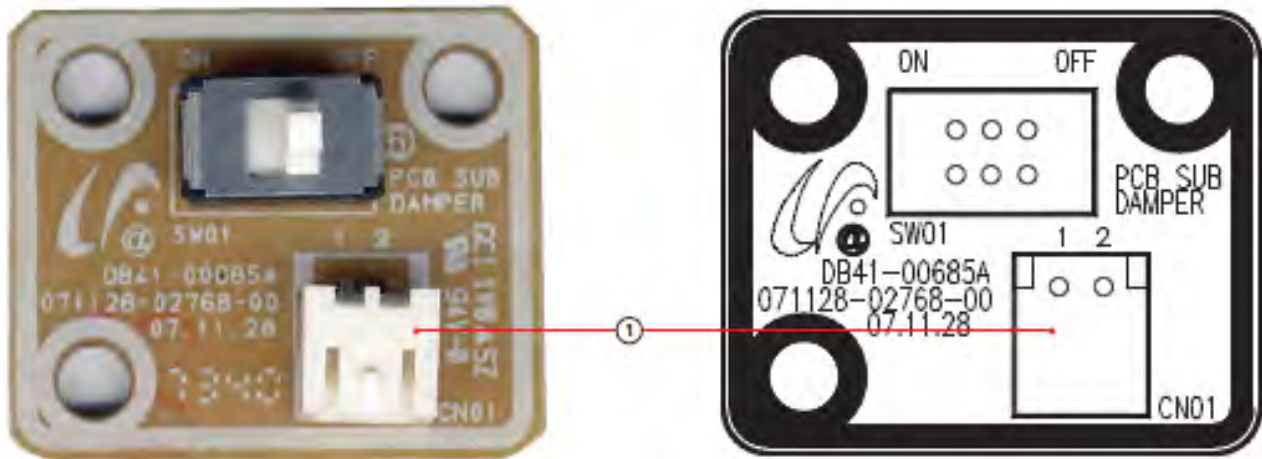

①	CN01-Damper S/W
#1 :	DC5V
#2 :	GND



## 5-4. Outdoor Unit Main PBA

■ PF2/3 : AC009/012/018BXADCH, AC018/024BXSCCC

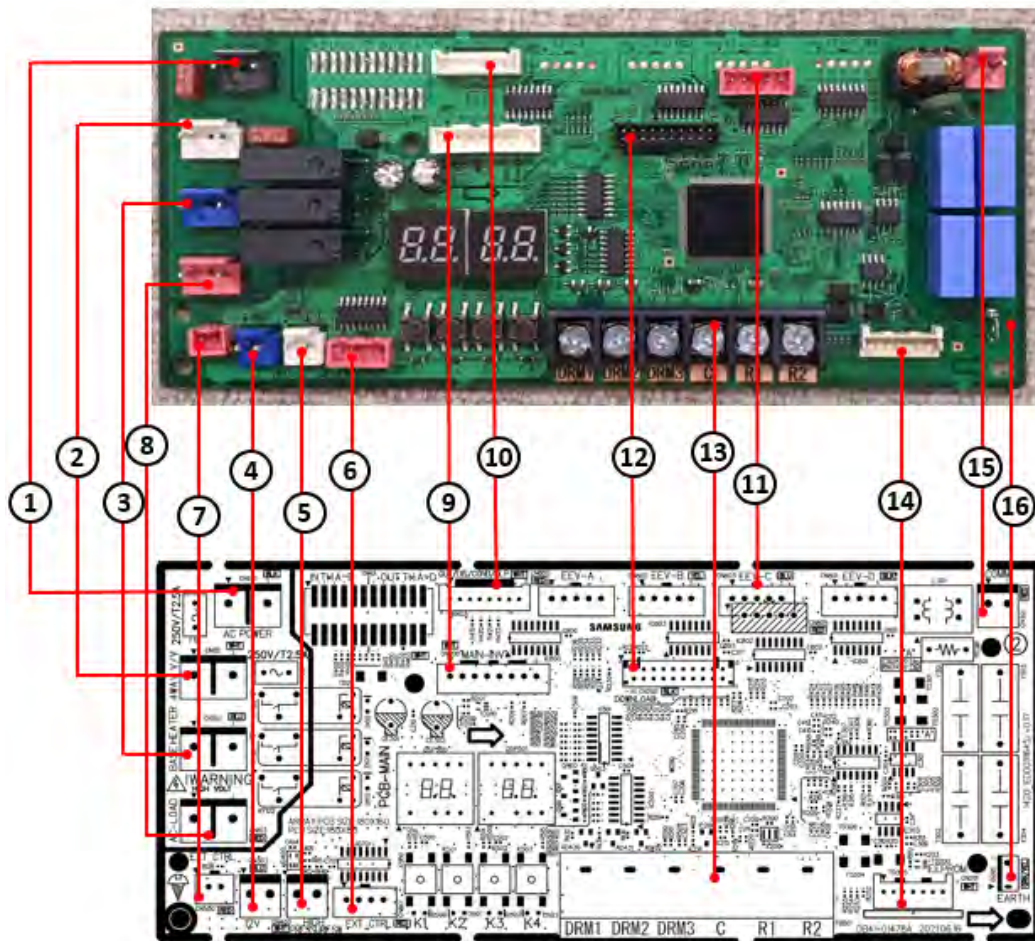

<p>① <b>CN100-AC POWER</b>                  #1 : L-LIVE POWER INPUT                  #2 : -                  #3 : N-NEUTRAL POWER INPUT</p>	<p>② <b>CN101 -4WAY VALVE</b>                  #1 : L-L PHASE OUTPUT                  #2 :                  #3 : N-N PHASE OUTPUT</p>	<p>③ <b>CN102-BASE HEATER</b>                  #1 : L-L PHASE OUTPUT                  #2 :                  #3 : N-N PHASE OUTPUT</p>	<p>④ <b>CN303-DC12V</b>                  #1 : DC 12V                  #2 : GND</p>
<p>⑤ <b>CN402-HIGH PRESSURE SWITCH</b>                  #1 : HIGH PRESSURE SWITCH INPUT SIGNAL                  #2 : GND</p>	<p>⑥ <b>CN501-ERROR CHECK/COMP CHECK</b>                  #1 : DC12V                  #2 : ERROR CHECK                  #3 : DC12V                  #4 : COMP CHECK</p>	<p>⑦ <b>CN500-EXTERNAL CONTROL</b>                  #1 : GND                  #2 :EXTERNAL INPUT</p>	<p>⑧ <b>CN103-BELT HEATER</b>                  #1 : L-L PHASE OUTPUT                  #2 :                  #3 : N-N PHASE OUTPUT</p>
<p>⑨ <b>CN200-MAIN ↔ INV COMM</b>                  #1 : TXD                  #2 : RXD                  #3 : DC5V                  #4 : GND                  #5 : DC12V                  #6 : INV POWER CTRL                  #7 : MAIN AC LOAD POWER CTRL                  #8 : -</p>	<p>⑩ <b>CN403-THERMISTOR</b>                  #1 : OUTDOOR SENSOR                  #3 : DISCHARGE SENSOR                  #5 : CONDENSOR SENSOR                  #7 : OLP SENSOR                  #2,4,6,8 : GND</p>	<p>⑪ <b>CN805-MAIN EEV</b>                  #1 : EEV C SIGNAL                  #2 : EEV C SIGNAL                  #3 : EEV C SIGNAL                  #4 : EEV C SIGNAL                  #5 : GND</p>	<p>⑫ <b>CN202-DOWNLOAD</b>                  #1~20 : DOWNLOAD SIGNAL</p>
<p>⑬ <b>TB001</b>                  #1 : DRED SIGNAL(DRM1)                  #2 : DRED SIGNAL(DRM2)                  #3 : DRED SIGNAL(DRM3)                  #4 : GND                  #5 : R1                  #6 : R2</p>	<p>⑭ <b>CN201-EEPROM</b>                  #1 : GND                  #2 : -                  #3 : 5V                  #4 : EEPROM SIGNAL                  #5 : EEPROM SIGNAL                  #6 : EEPROM SIGNAL                  #7 : EEPROM SIGNAL</p>	<p>⑮ <b>CN301-ODU ↔ IDU COMM</b>                  #1 : F1                  #2 : F2</p>	<p>⑯ <b>CN305-COMMUNICATION EMI EARTH</b>                  #1 : EARTH</p>

■ PF4/5 : AC024/030/036/042/048BXADCH, AC030/036BXSCCC, AC030/036BXSCCH

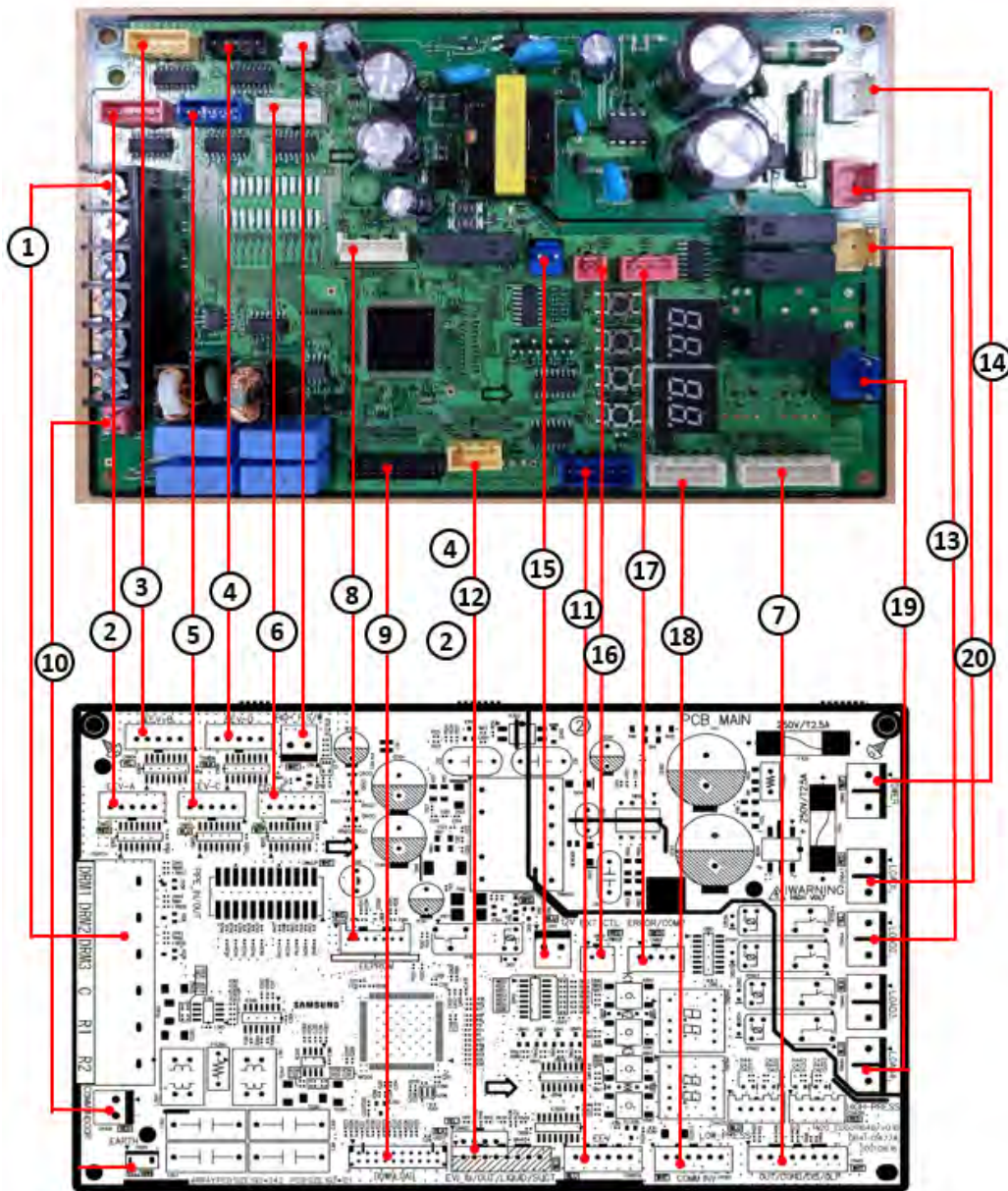

<p>① <b>CN303 - DRED &amp; UPPER CTRL</b>                      #1 : DRED SIGNAL(DRM1)                      #2 : DRED SIGNAL(DRM2)                      #3 : DRED SIGNAL(DRM3)                      #4 : GND                      #5 : R1                      #6 : R2</p>	<p>② <b>CN803 - EEV A</b>                      #1 : EEV A SIGNAL                      #2 : EEV A SIGNAL                      #3 : EEV A SIGNAL                      #4 : EEV A SIGNAL                      #5 : GND</p>	<p>③ <b>CN804 - EEV B</b>                      #1 : EEV B SIGNAL                      #2 : EEV B SIGNAL                      #3 : EEV B SIGNAL                      #4 : EEV B SIGNAL                      #5 : GND</p>	<p>④ <b>CN806 - EEV D</b>                      #1 : EEV D SIGNAL                      #2 : EEV D SIGNAL                      #3 : EEV D SIGNAL                      #4 : EEV D SIGNAL                      #5 : GND</p>
<p>⑤ <b>CN805 - MAIN EEV</b>                      #1 : EEV D SIGNAL                      #2 : EEV D SIGNAL                      #3 : EEV D SIGNAL                      #4 : EEV D SIGNAL                      #5 : GND</p>	<p>⑥ <b>CN807 - EEV E</b>                      #1 : EEV A SIGNAL                      #2 : EEV A SIGNAL                      #3 : EEV A SIGNAL                      #4 : EEV A SIGNAL                      #5 : GND</p>	<p>⑦ <b>CN401 - THERMISTOR</b>                      #1 : OUTDOOR SENSOR                      #3 : DISCHARGE SENSOR                      #5 : CONDENSOR SENSOR                      #7 : OLP SENSOR                      #2,4,6,8 : GND</p>	<p>⑧ <b>CN200 - EEPROM</b>                      #1 : GND                      #2 : -                      #3 : 5V                      #4 : EEPROM SIGNAL                      #5 : EEPROM SIGNAL                      #6 : EEPROM SIGNAL                      #7 : EEPROM SIGNAL</p>
<p>⑨ <b>CN306 - DOWNLOAD</b>                      #1~20 : DOWNLOAD SIGNAL</p>	<p>⑩ <b>CN303 - ODU↔IDU COMM</b>                      #1 : F1                      #2 : F2</p>	<p>⑪ <b>CN809 - MAIN EEV (EDM)</b>                      #1 : EEV A SIGNAL                      #2 : EEV A SIGNAL                      #3 : EEV A SIGNAL                      #4 : EEV A SIGNAL                      #5 : GND</p>	<p>⑫ <b>CN402 -THERMISTOR</b>                      #1 : ESC IN THERMISTOR                      #3 : ESC OUT THERMISTOR                      #2,4 : GND</p>
<p>⑬ <b>CN844 - 4WAY VALVE</b>                      #1 : L - L PHASE OUTPUT                      #2 : -                      #3 : N - N PHASE OUTPUT</p>	<p>⑭ <b>CN101 - AC POWER INPUT</b>                      #1 : L - LIVE POWER INPUT                      #2 : -                      #3 : N - NEUTRAL POWER INPUT</p>	<p>⑮ <b>CN12 - DC12V</b>                      #1 : 12V                      #2 : GND</p>	<p>⑯ <b>CN800-EXTERNAL CONTROL</b>                      #1 : GND                      #2 : EXTERNAL INPUT</p>
<p>⑰ <b>CN801-ERRORCHECK.COMP CHECK</b>                      #1 : DC 12V                      #2 : ERROR CHECK                      #3 : DC 12V                      #4 : COMP CHECK</p>	<p>⑱ <b>CN302 - MAIN↔INV COMM</b>                      #1 : TXD                      #2 : RXD                      #3 : GND                      #4 : DC 5V                      #5 : DC 12V                      #6 : INV POWER CTRL</p>	<p>⑲ <b>CN845 - BASE HEATER</b>                      #1 : N - NEUTRAL POWER OUTPUT                      #2 : -                      #3 : L - RELAY CONTACT OUTPUT</p>	<p>⑳ <b>CN846 - BELT HEATER</b>                      #1 : N - NEUTRAL POWER OUTPUT                      #2 : -                      #3 : L - RELAY CONTACT OUTPUT</p>

## 5-5. Outdoor Unit Inverter PBA

### ■ PF2 : AC009BXADCH

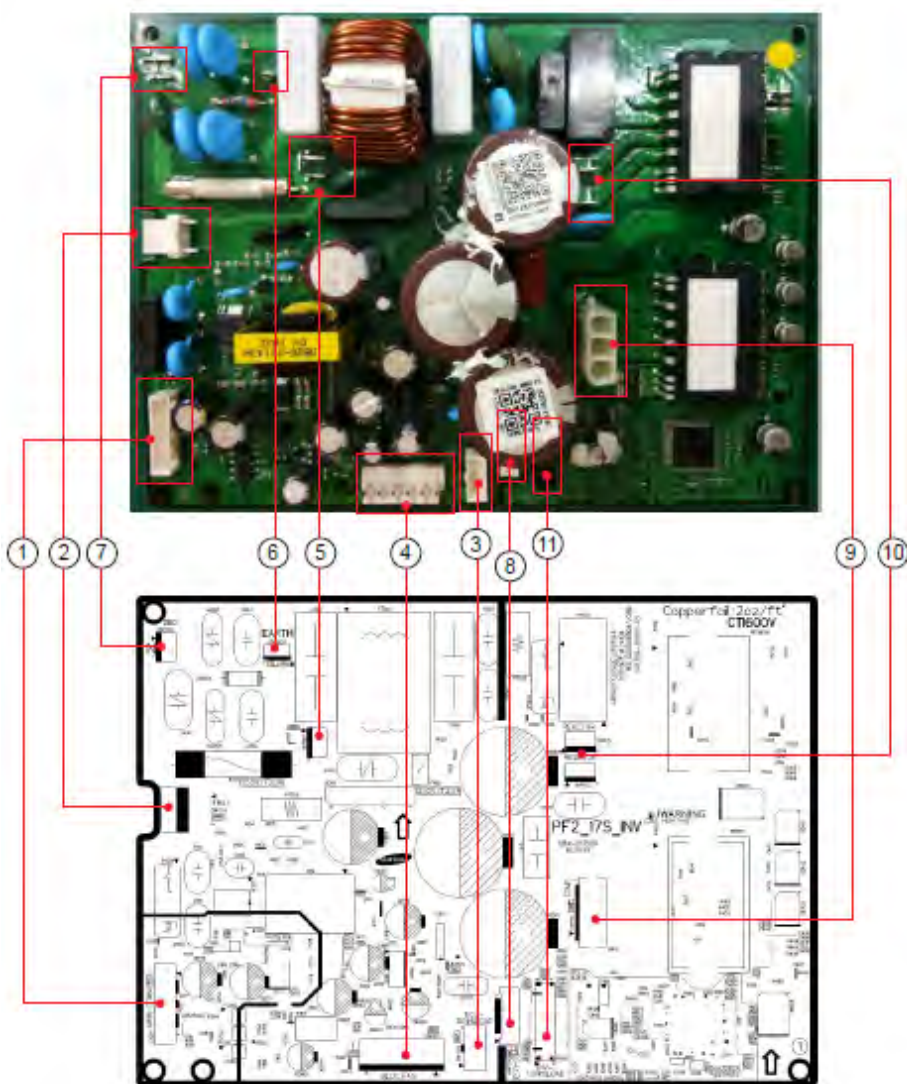

<b>1. CNP351-MAIN INV</b> #1 : RXD #2 : TXD #3 : DC5V #4 : GND #5 : DC12V #6 : POWER CTRL #7 : 4WAY(AC LOAD) #8 : -	<b>2. CN031-MAIN POWER</b> #1 : N #2 : - #3 : L	<b>3. CN552-ECO DOWNLOAD</b> #1 : RXD_INV #2 : TXD_INV #3 : GND #4 : DC5V	<b>4. CNP901</b> #1 : DC310V #2 : - #3 : GND #4 : DC15V #5 : V_SP #6 : F/B
<b>5. CN001-L/TAP TERMINAL</b> #1 : L	<b>6. CN003- EARTH/TAP TERMINAL</b> #1 : EARTH	<b>7. CN002-N/TAP TERMINAL</b> #1 : N	<b>8. CNP361-ECO DOWNLOAD</b> #1~7 : ECO COMM PART
<b>9. CN401-COMP</b> #1 : W Phase #2 : V Phase #3 : U Phase	<b>10. CN051, CNP052-REACTOR</b> #1 : REACTOR	<b>11. DOWNLOAD</b> #1~20 : DOWNLOAD	

■ PF3 : AC018BXADCH, AC018/024BXSCCC

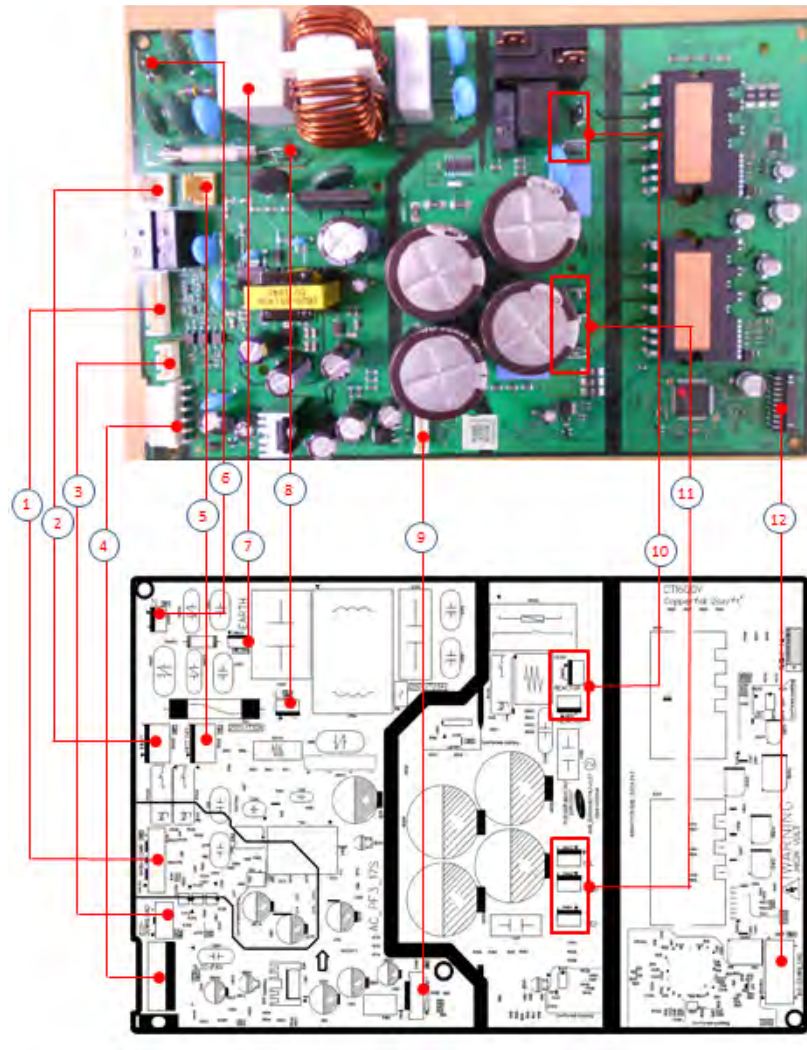

This Document can not be used without Samsung's authorization.

<p>① <b>CNP351-MAIN INV</b></p> <p>#1: RXD #2: TXD #3: DC5V #4: GND #5: DC12V #6: POWER CTRL #7: AC LOAD #8: AC LOAD2</p>	<p>② <b>CN030-MAIN POWER</b></p> <p>#1: N #2: - #3: L</p>	<p>③ <b>CN571-ECO DOWNLOAD</b></p> <p>#1~4: ECO DOWNLOAD</p>	<p>④ <b>CNP901- BLDC FAN</b></p> <p>#1: DC310V #2: - #3: PGND #4: DC15V #5: V_SP #6: F/B</p>
<p>⑤ <b>CN241-HOT GAS (AC LOAD)</b></p> <p>#1: L/RELAY CONTACT #2: - #3: N</p>	<p>⑥ <b>CN001-N / TAP TERMINAL</b></p> <p>#1: N</p>	<p>⑦ <b>CN571-EARTH TAP TERMINAL</b></p> <p>#1: EARTH</p>	<p>⑧ <b>CN002-L / TAP TERMINAL</b></p> <p>#1: L</p>
<p>⑨ <b>CN581-ECO COMM</b></p> <p>#1~7: ECO COMM port</p>	<p>⑩ <b>CN401, 402, 403-COMP</b></p> <p>#CN401: U, RED #CN402: V, BLU #CN403: W, YEL</p>	<p>⑪ <b>CN051, 052-REACTOR</b></p> <p>#CN501,052: REACTOR</p>	<p>⑫ <b>CN551-DOWNLOAD</b></p> <p>#1~20: DOWNLOAD</p>

This Document can not be used without Samsung's authorization.

■ PF4 : AC024/030/036BXADCH, AC030/036BXSCCC

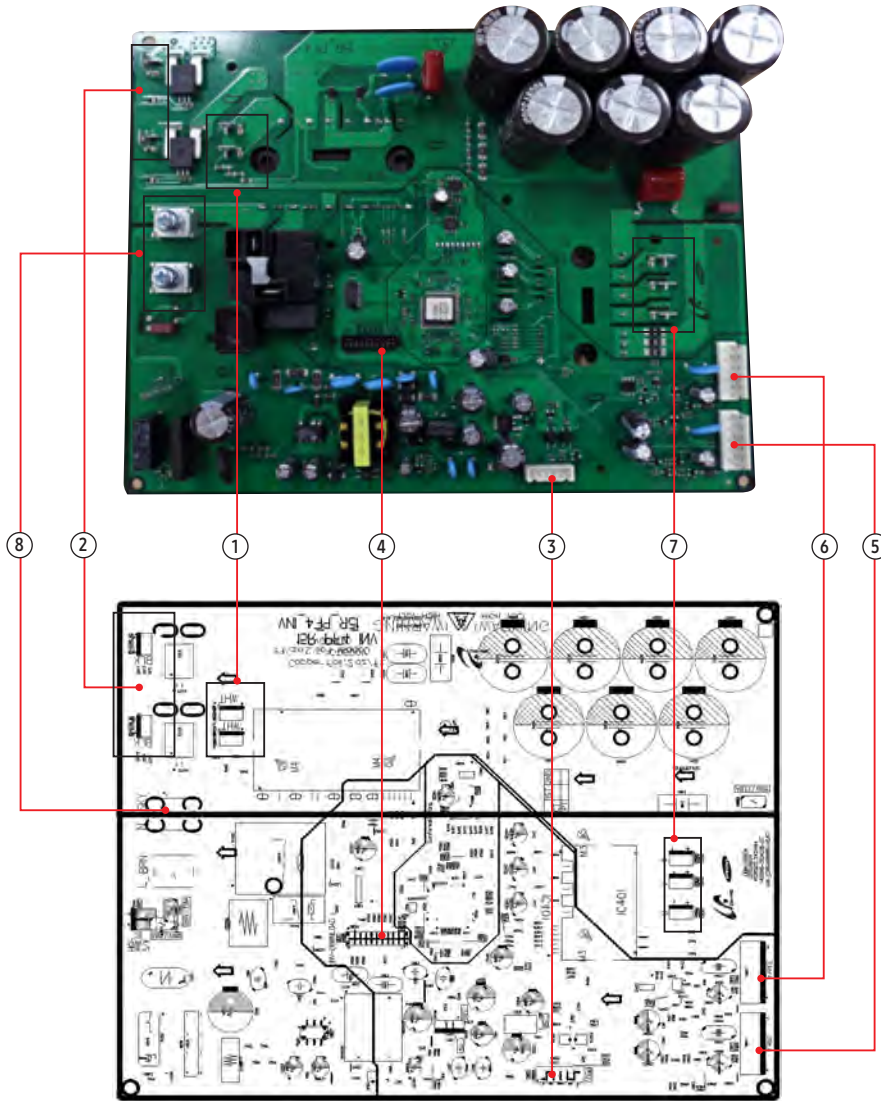

<p>① REACTOR : A1/B1 #REACTOR - A1 :WHT #REACTOR - B1 : WHT</p>	<p>② REACTOR : A2/B2 #REACTOR - A2 : BLK #REACTOR - B2 : BLK</p>	<p>③ CN351 : Main COMM #1 : RXD #2 : TXD #3 : GND #4 : DC 5V #5 : DC 12V #6 : INV,SMP5 SIGNAL</p>	<p>④ CN551 : DOWNLOAD</p>
<p>⑤ CN901 : Fan 1 #1 : DC 310V #3 : GND #4 : DC 15V #5 : FAN RPM #6 : FAN RPM FEEDBACK</p>	<p>⑥ CN911 : Fan 2 #1 : DC 310V #3 : GND #4 : DC 15V #5 : FAN RPM #6 : FAN RPM FEEDBACK</p>	<p>⑦ CN401 : COMP #1 : COMP-U PHASE #2 : COMP-V PHASE #3 : COMP-W PHASE</p>	<p>⑧ L,N : AC POWER #L_BRN : AC POWER(L)/BRN #N_SKY : AC POWER(N)/SKY</p>



■ PF5 : AC042/048BXADCH, AC030/036BXSCCH

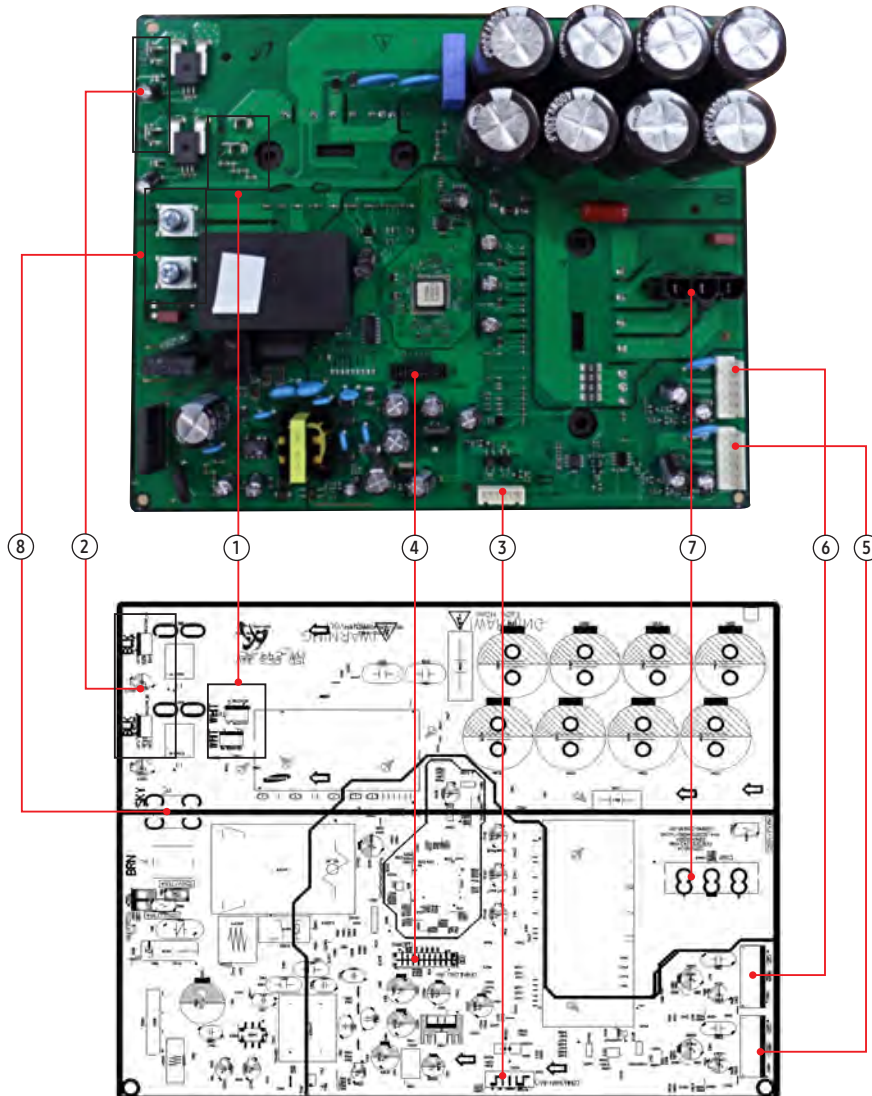

<p>① <b>REACTOR : A1/B1</b>                      #REACTOR - A1 :WHT                      #REACTOR - B1 :WHT</p>	<p>② <b>REACTOR : A2/B2</b>                      #REACTOR - A2 : BLK                      #REACTOR - B2 : BLK</p>	<p>③ <b>CN351 : Main COMM</b>                      #1 : RXD                      #2 : TXD                      #3 : GND                      #4 : DC 5V                      #5 : DC 12V                      #6 : INV,SMP5 SIGNAL</p>	<p>④ <b>CN551 : DOWNLOAD</b></p>
<p>⑤ <b>CN901 : Fan 1</b>                      #1 : DC 310V                      #3 : GND                      #4 : DC 15V                      #5 : FAN RPM                      #6 : FAN RPM FEEDBACK</p>	<p>⑥ <b>CN911 : Fan 2</b>                      #1 : DC 310V                      #3 : GND                      #4 : DC 15V                      #5 : FAN RPM                      #6 : FAN RPM FEEDBACK</p>	<p>⑦ <b>CN401 : COMP</b>                      #1 : COMP-U PHASE                      #2 : COMP-V PHASE                      #3 : COMP-W PHASE</p>	<p>⑧ <b>L,N : AC POWER</b>                      #L_BRN : AC POWER(L)/BRN                      #N_SKY : AC POWER(N)/SKY</p>

## 5-6. Outdoor Unit EMI PBA

■ AC024/030/036/042/048BXADCH, AC030/036BXSCCC, AC030/036BXSCCH

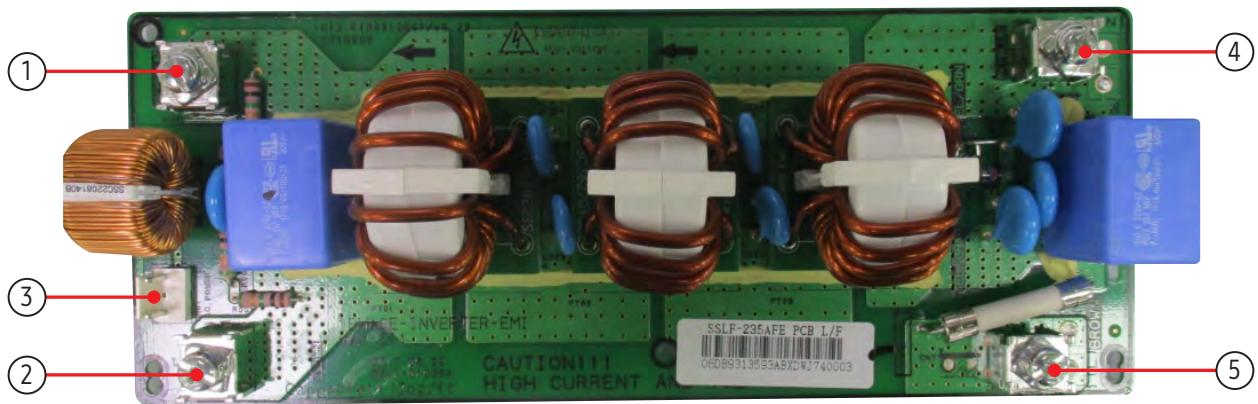

<p>① NT: AC POWER(N) #1: AC POWER(N)</p>	<p>② L1: AC POWER(L) #1: AC POWER(L)</p>	<p>③ CN01: POWER #1: AC POWER(L) #3: AC POWER(N)</p>	<p>④ CN5: AC POWER(N) #1: AC POWER(N)</p>
<p>⑤ CN4: AC POWER(L) #1: AC POWER(L)</p>			

## 6. Wiring Diagram

### 6-1. Indoor Unit

- 1way Cassette, 4way Cassette, 4way Cassette(600X600)  
: AC\*\*\*BN1DCH, AC\*\*\*BN4DCH, AC\*\*\*BNNDC

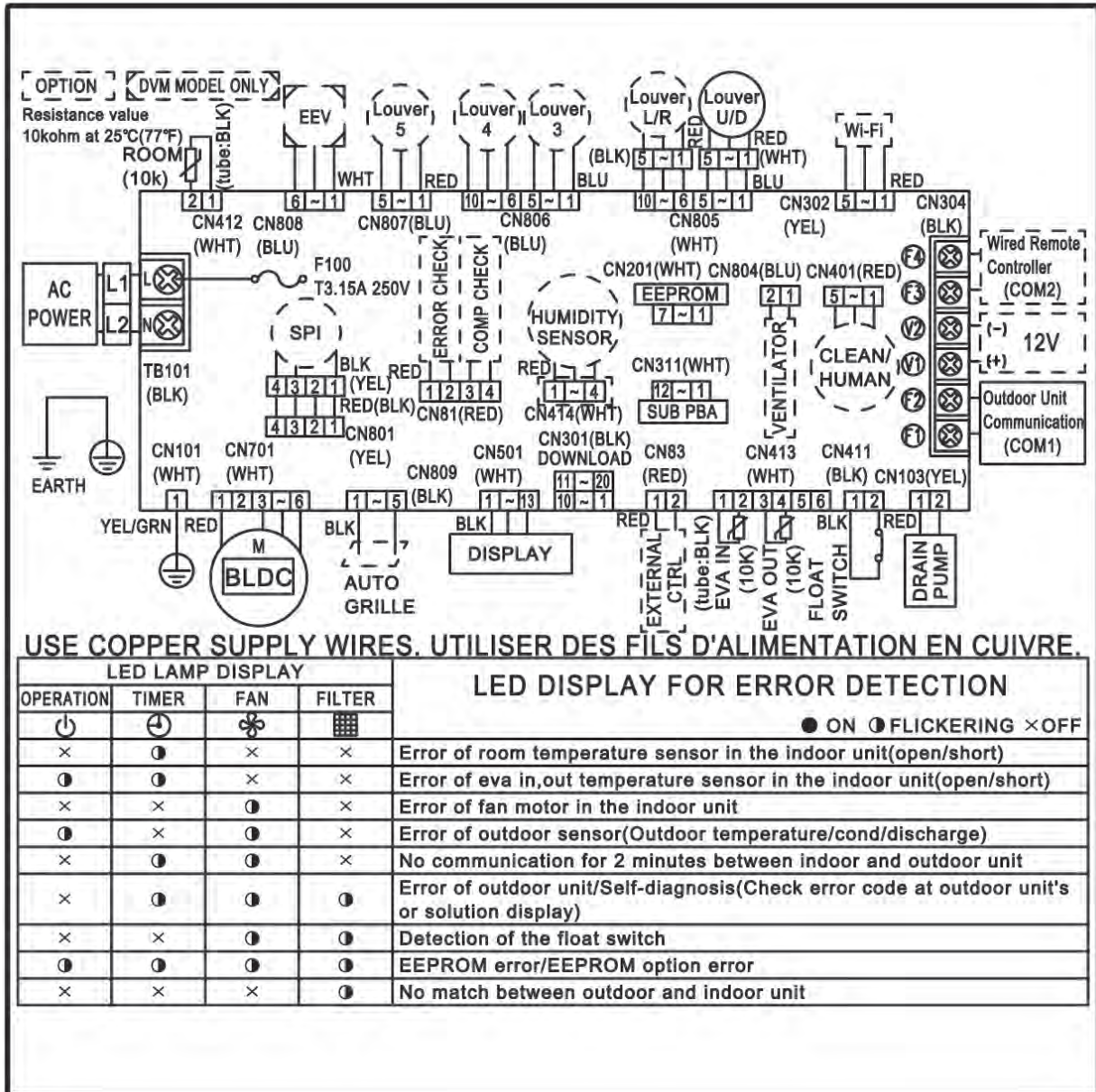

This Document can not be used without Samsung's authorization.

## Indoor Unit (cont.)

### ■ 360 Cassette : AC\*\*\*BN6DCH

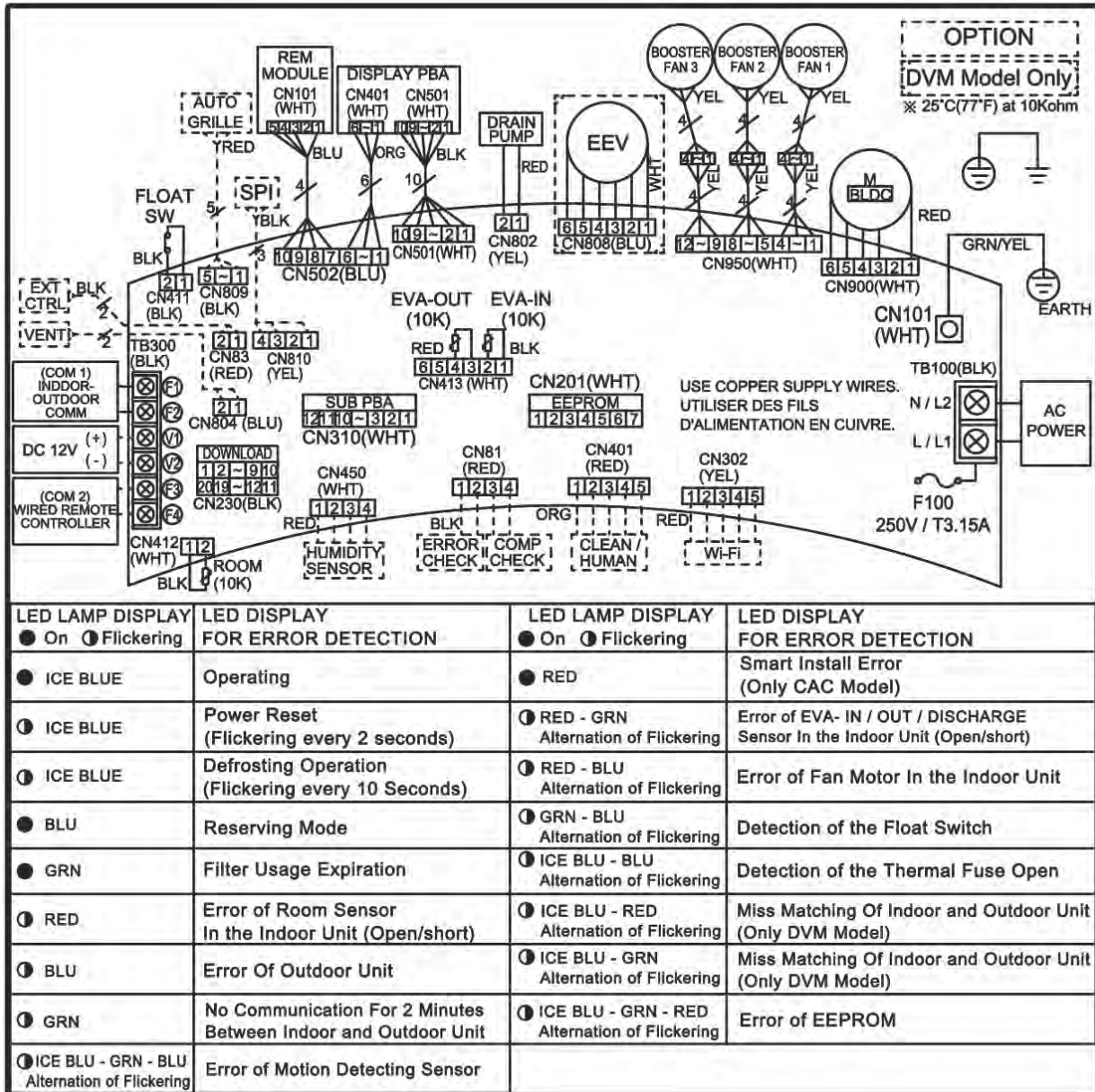

# Indoor Unit (cont.)

## ■ Home duct : AC\*\*\*BNLDCH

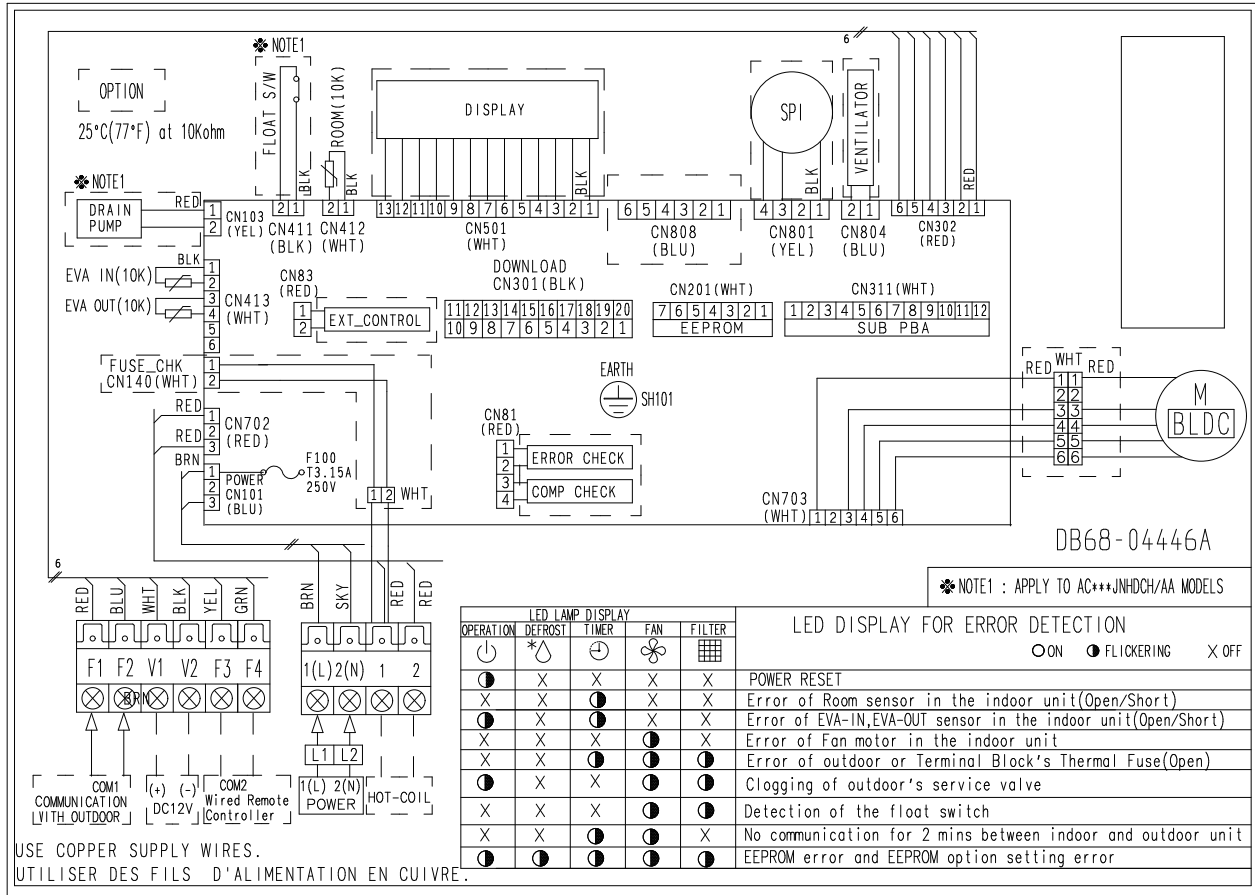

This Document can not be used without Samsung's authorization.

# Indoor Unit (cont.)

## ■ Duct S : AC\*\*\*BNHDCH

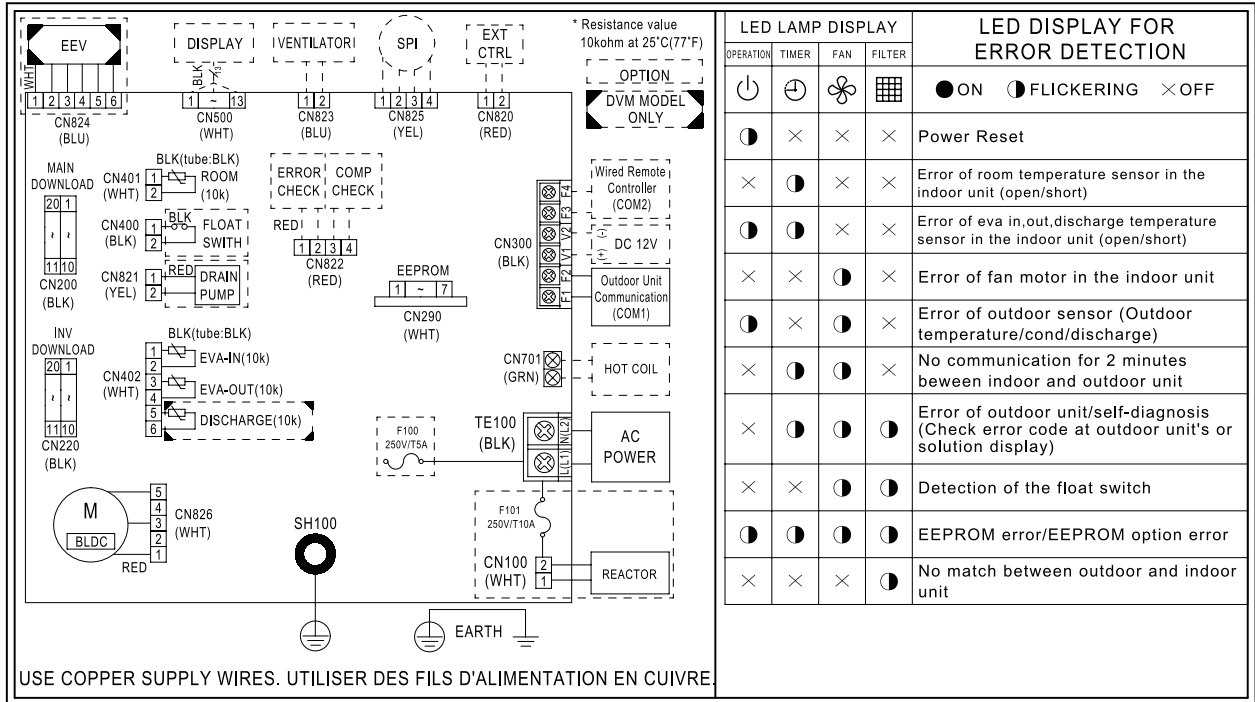

# Indoor Unit (cont.)

## ■ RAC : AC018/024BNADCH

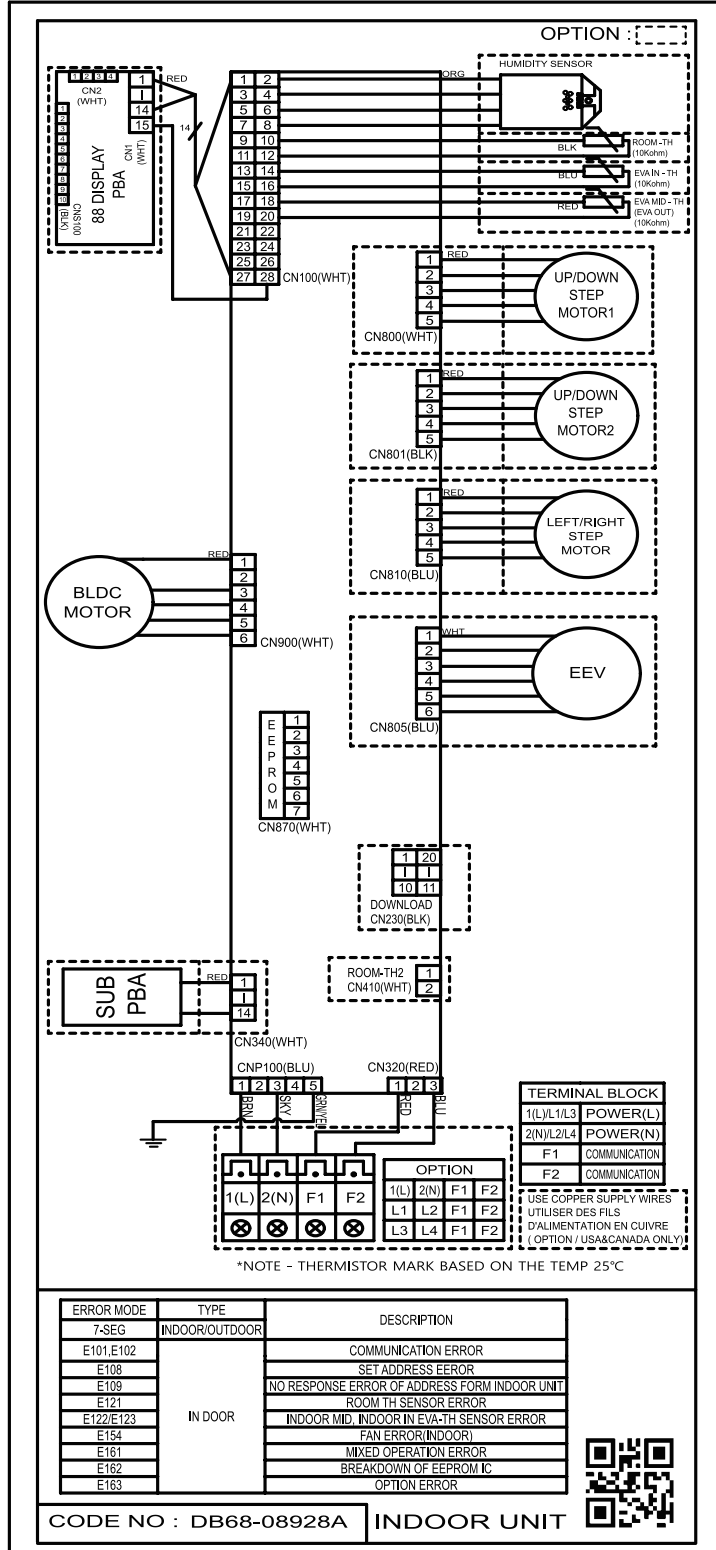

This Document can not be used without Samsung's authorization.

# Indoor Unit (cont.)

## ■ RAC : AC030/036BNTDCH

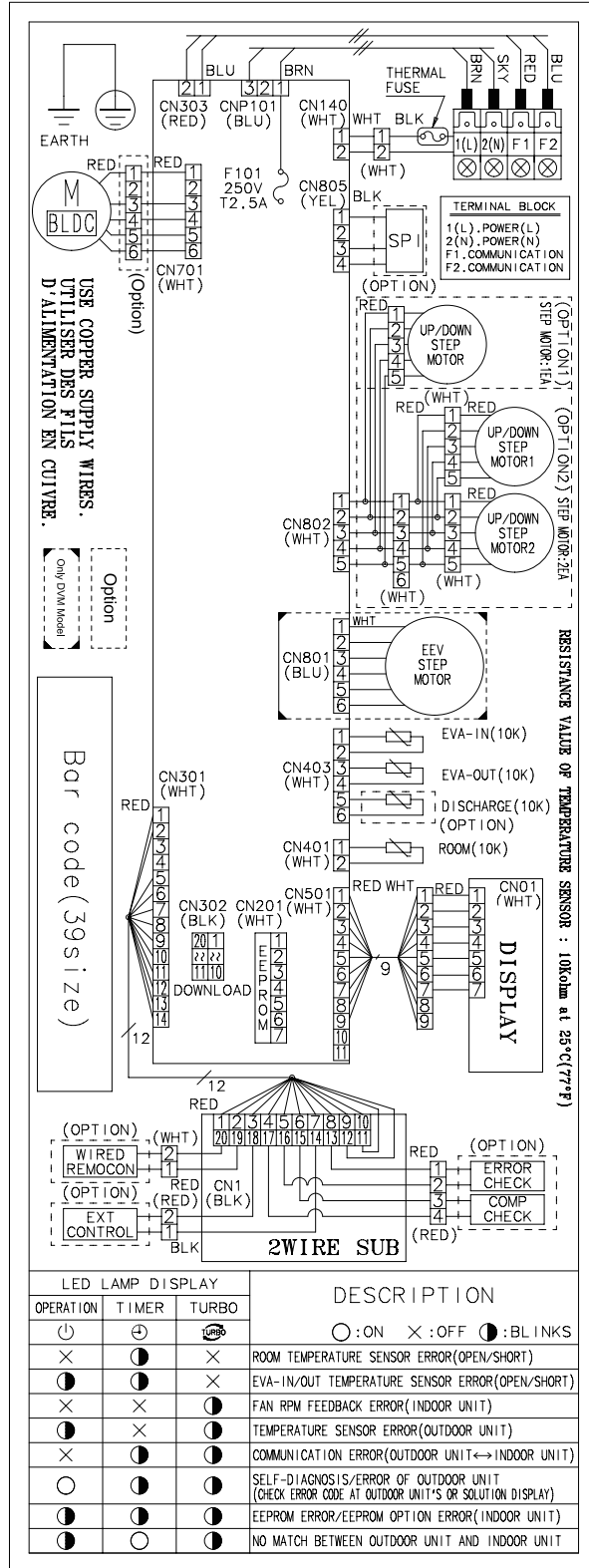

This Document can not be used without Samsung's authorization.



# Indoor Unit (cont.)

■ Console : AC\*\*\*BNJDCH

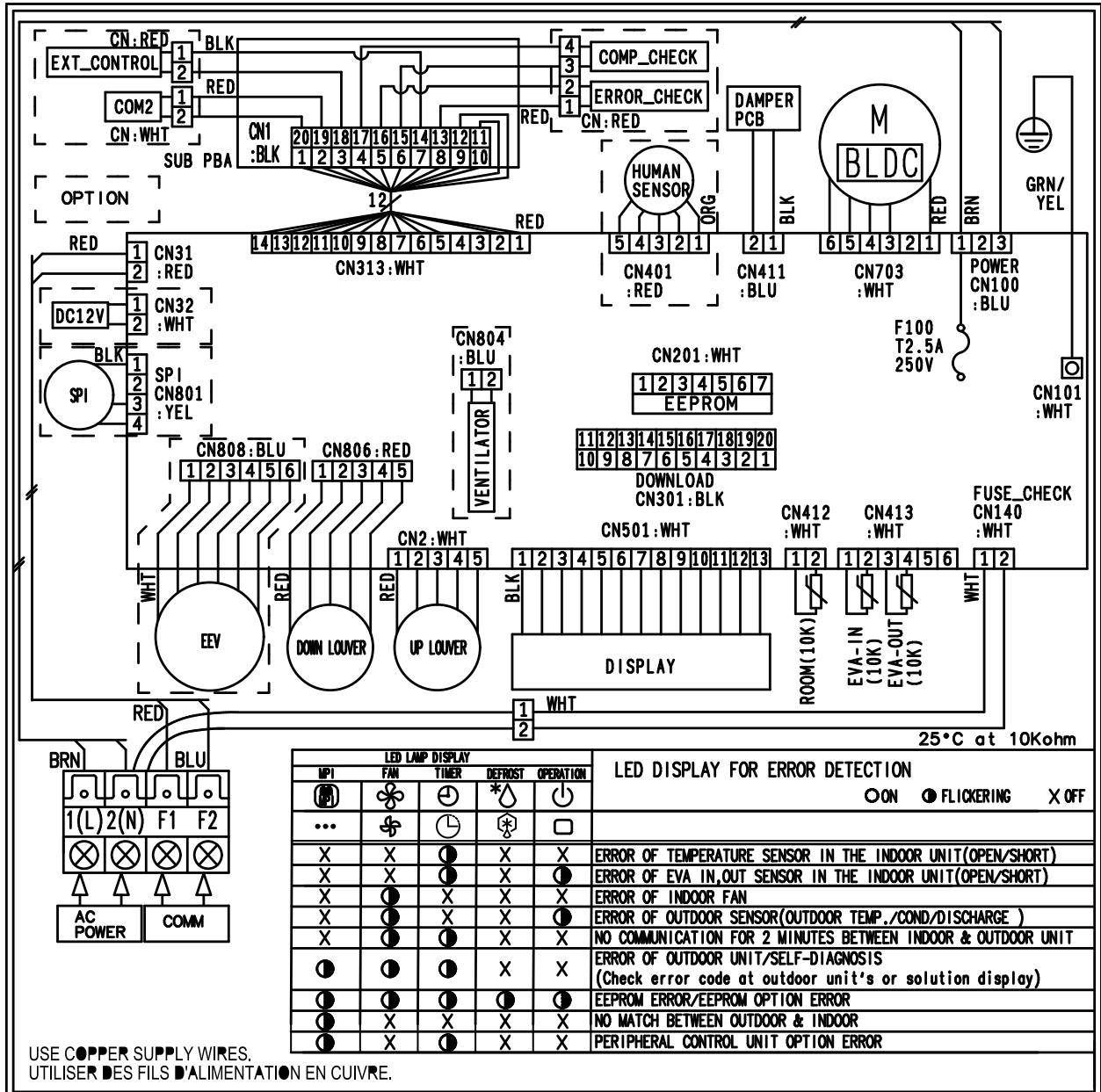

This Document can not be used without Samsung's authorization.

# Indoor Unit (cont.)

■ MPAH : AC\*\*\*BNZDCH, AC\*\*\*KNZDCH

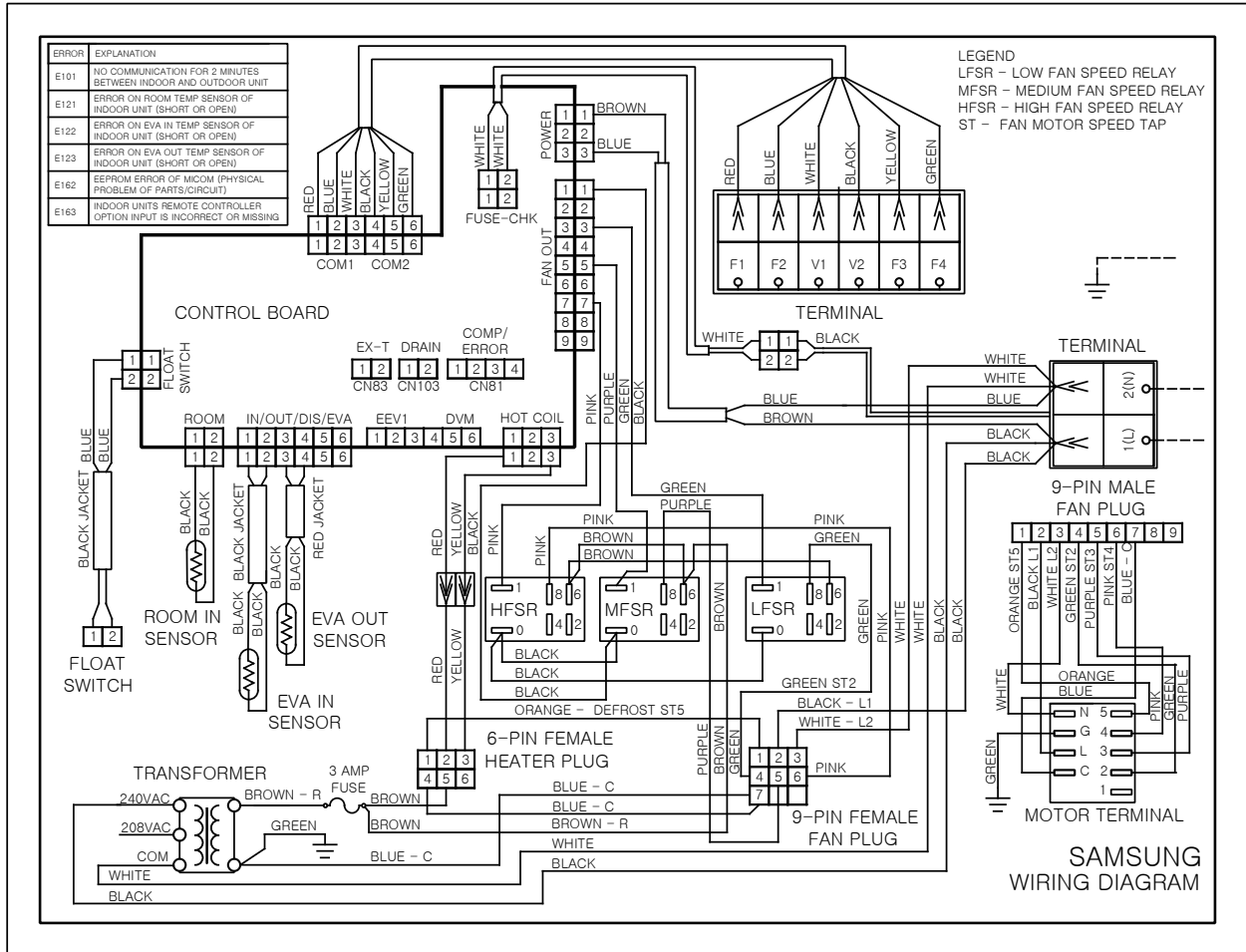

This Document can not be used without Samsung's authorization.

## 6-2. Outdoor unit

### PF#2 : AC009/012BXADCH

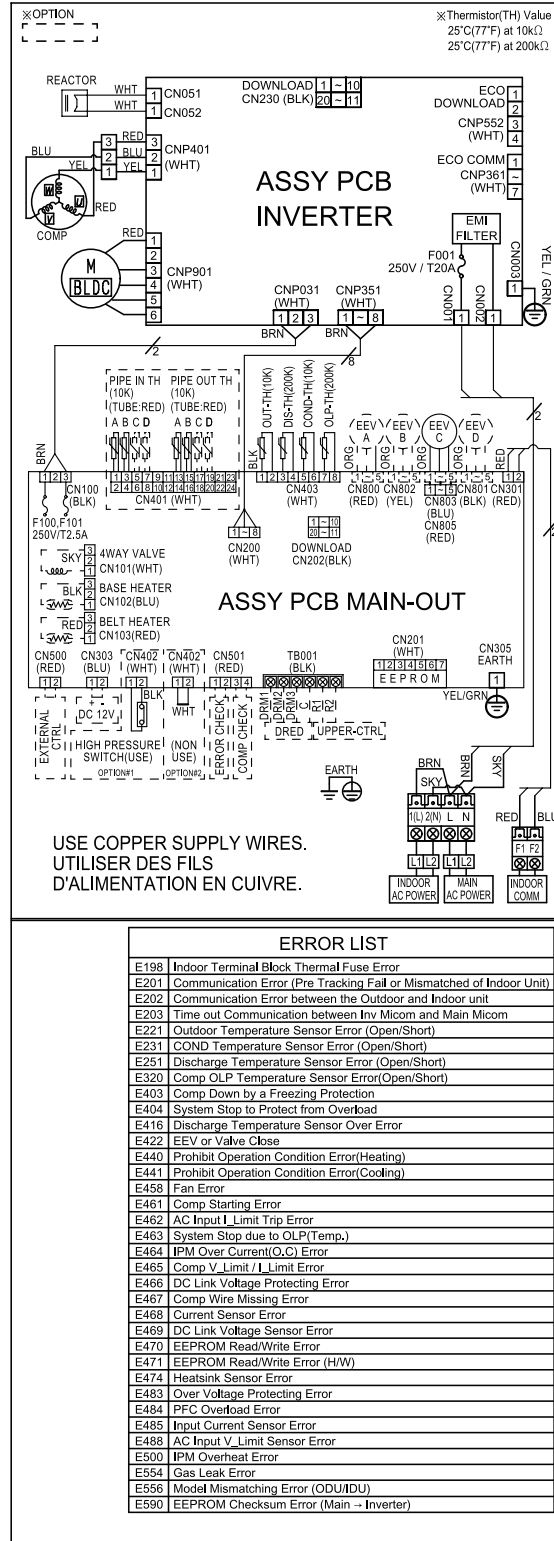

This Document can not be used without Samsung's authorization.

# Outdoor unit (cont.)

## ■ PF#3 : AC018BXADCH, AC018/024BXSCCC

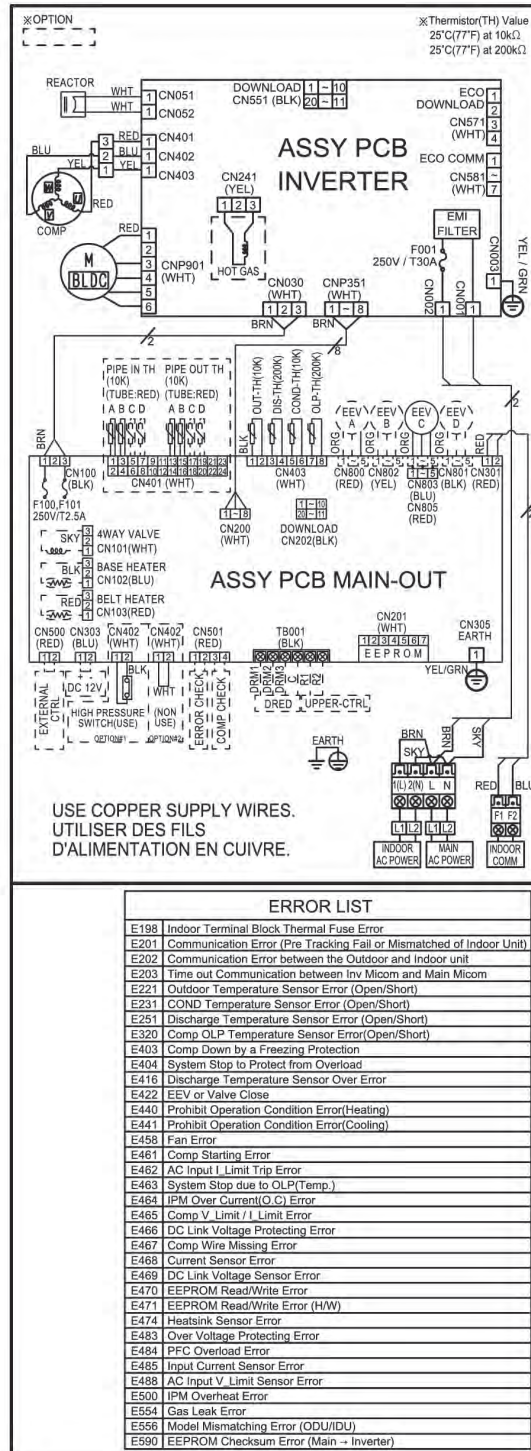

## Outdoor unit (cont.)

■PF#4/5 : AC024/030/036/042/048BXADCH, AC030/036BXSCC, AC030/036BXSCCH

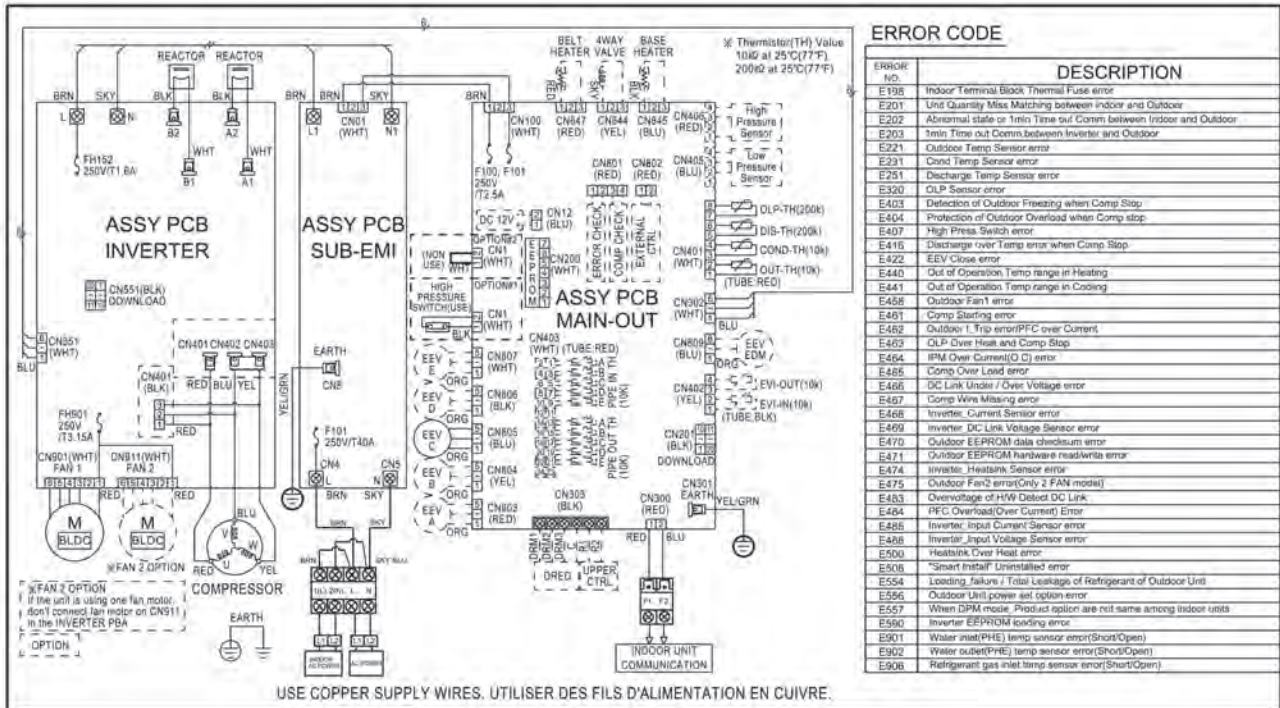

# 7. Reference Sheet

## 7-1. Index for Model Name

### 7-1-1. Indoor Unit

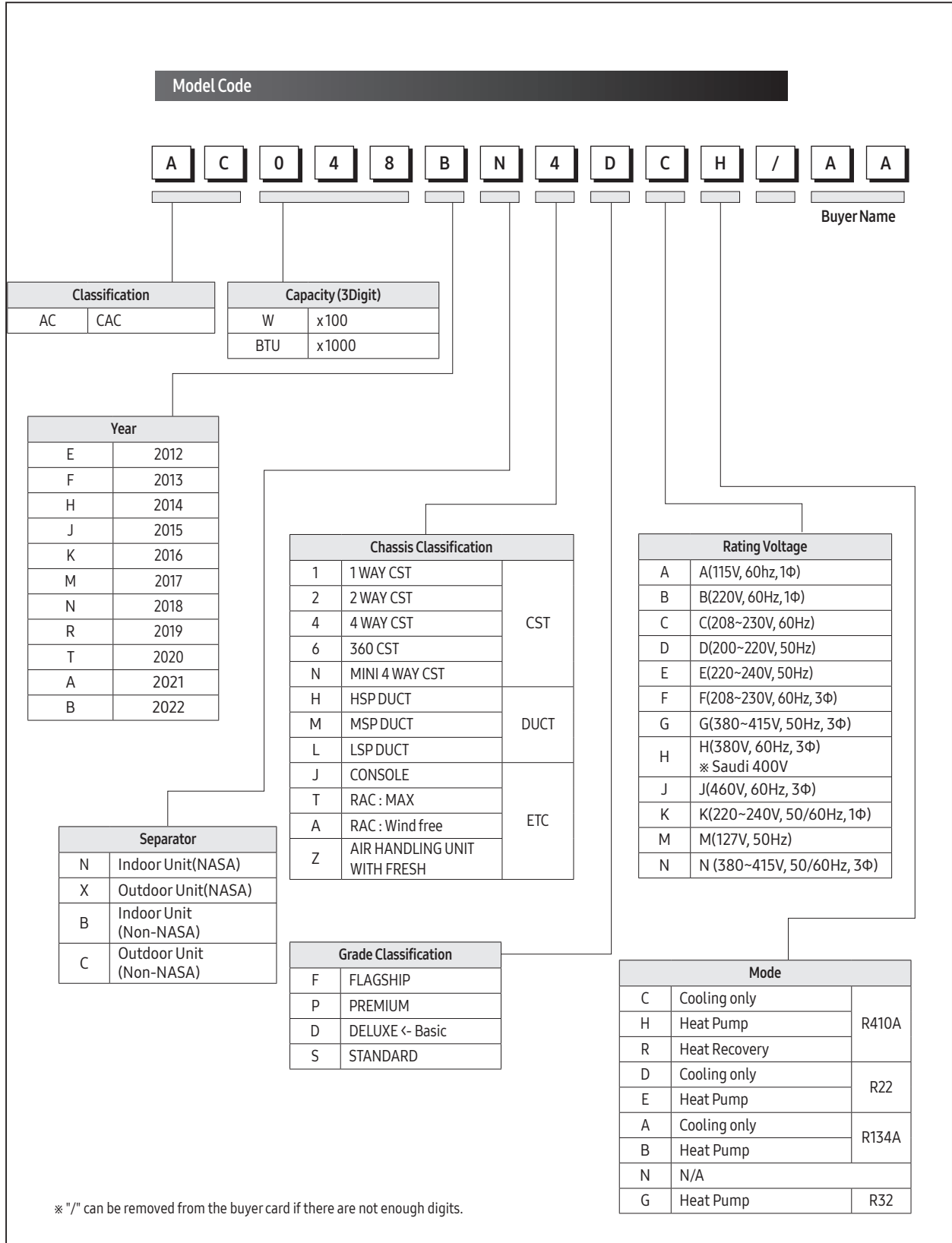

## Index for Model Name (cont.)

### 7-1-2. Outdoor Unit

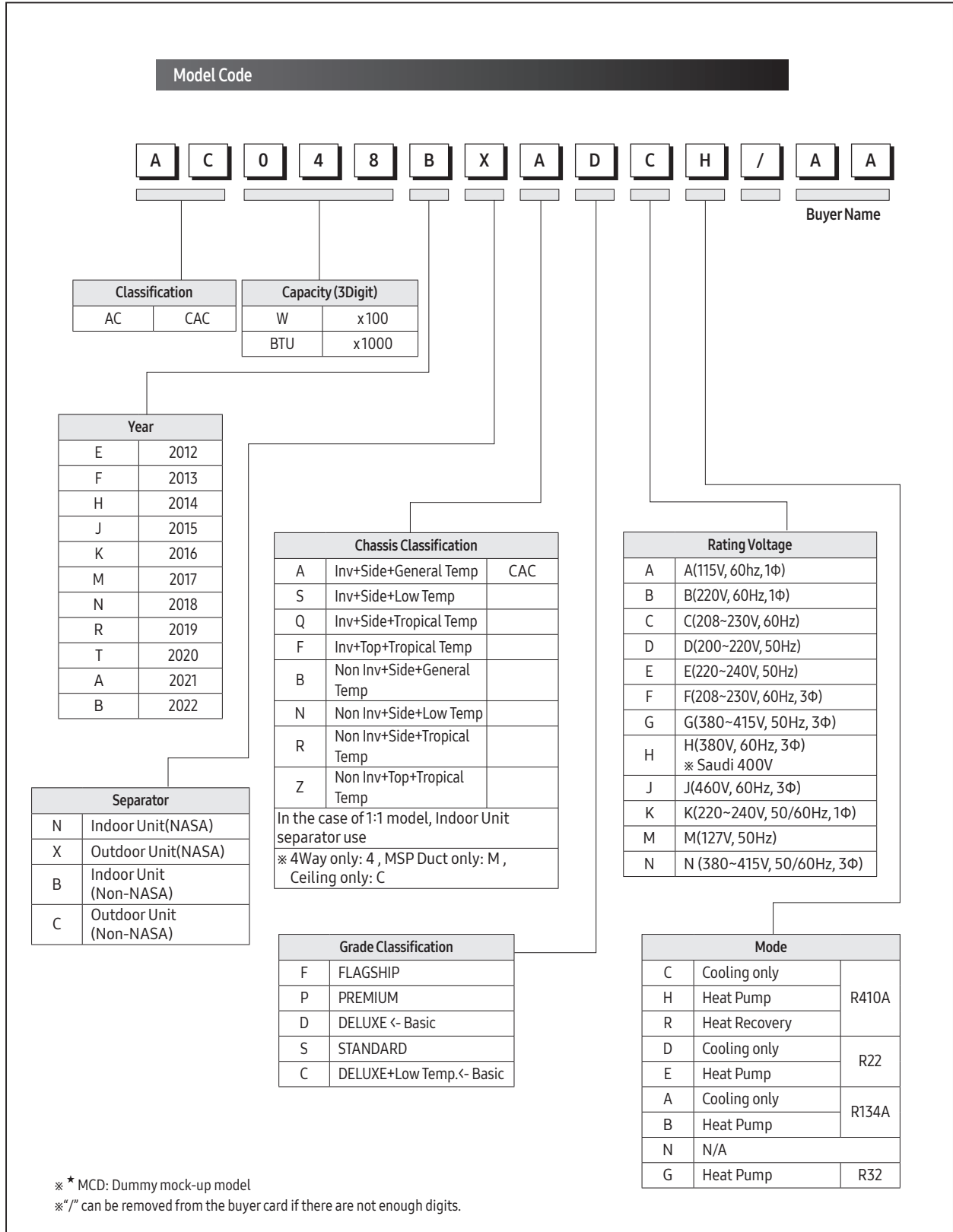

# Index for Model Name (cont.)

## 7-1-3. Panel

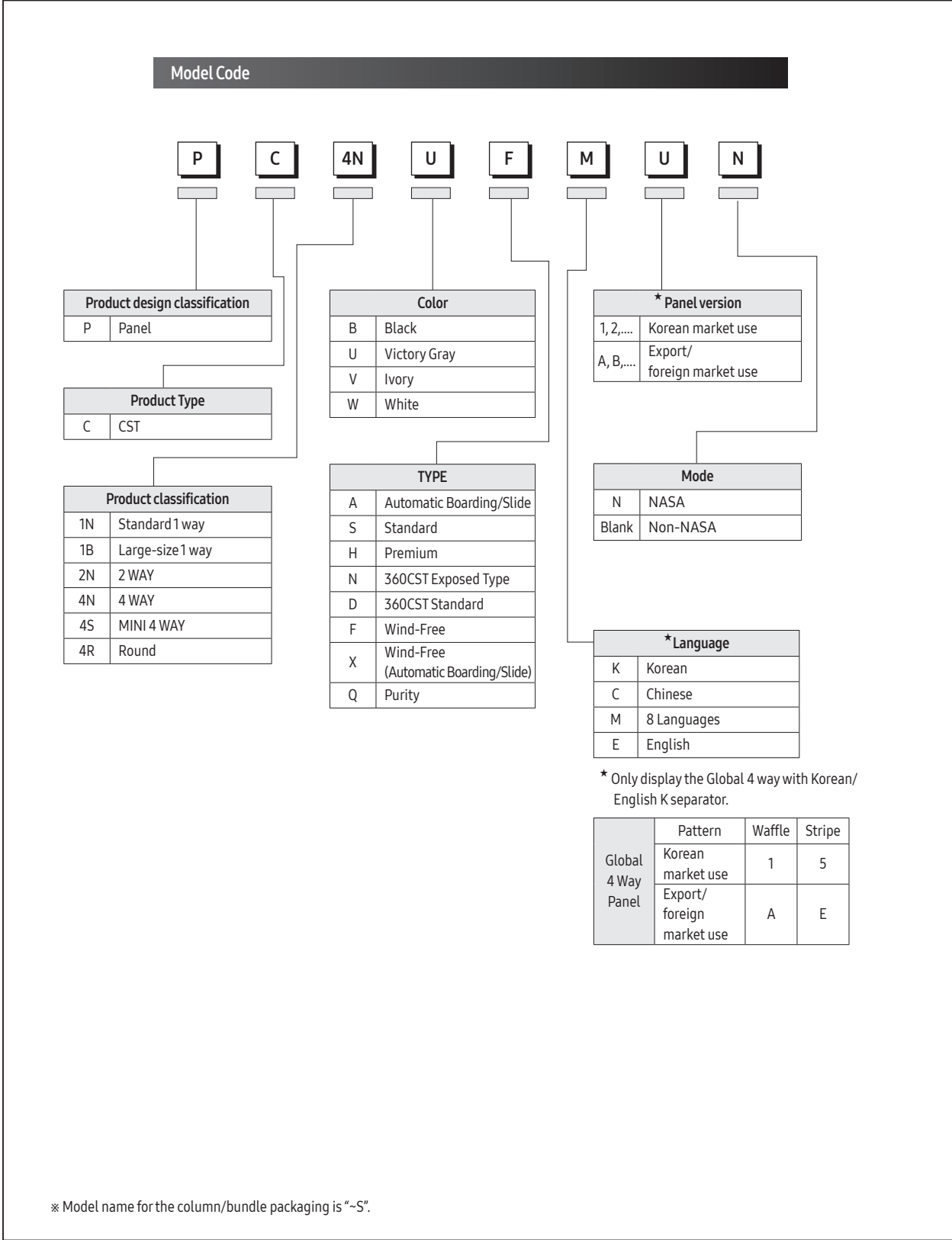



## 7-2. Refrigerating Cycle Diagram

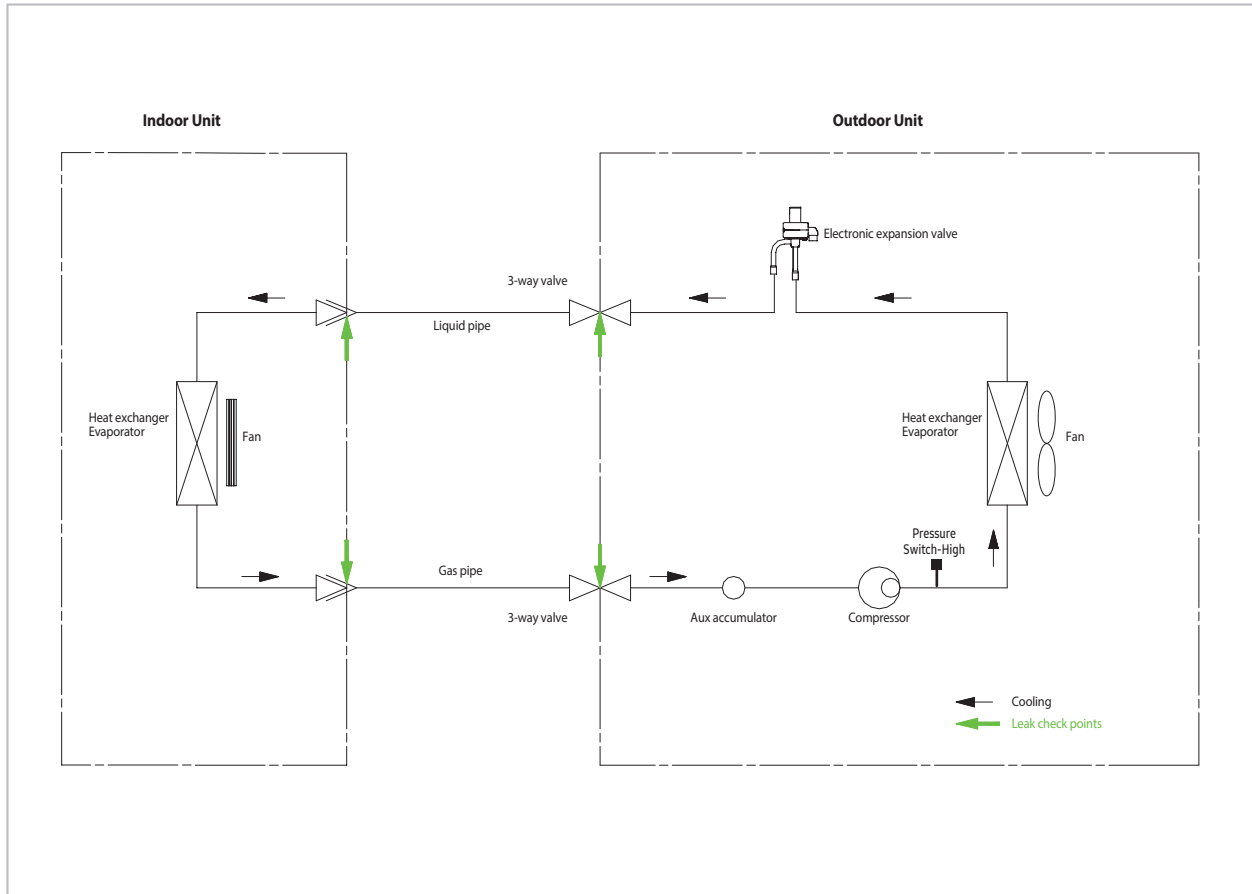

### ■ CONDENSER

High temperature and high pressure gas state refrigerant discharged from the compressor is converted to a liquid state as it is cooled down by the heat emission in the outdoor condenser unit, and sent to the evaporator.

### ■ COMPRESSOR

Low temperature and low pressure refrigerant is compressed and sent to the cycling system.

### ■ EVAPORATOR

Liquid refrigerant sucked in through the capillary tubes cools down the room by absorbing the surrounding heat as it evaporates (converting from liquid to gas). (Absorbing heat required for evaporation)

### ■ SERVICE VALVE

You can open the valve by turning the need valve counterclockwise using hex wrench, and it is used for vacuum, gas purging, refrigerant injection, refrigerant purging, and indoor-outdoor unit connection.

### ■ ACCUMULATOR

Accumulator prevents the flow of liquid-state refrigerant into the compressor. (Liquid-state refrigerant flowing into the compressor will overload the compressor.)



### **GSPN (GLOBAL SERVICE PARTNER NETWORK)**

<b>Area</b>	<b>Web Site</b>
Europe, CIS, Mideast & Africa	<a href="http://gspn1.samsungcsportal.com">gspn1.samsungcsportal.com</a>
Asia	<a href="http://gspn2.samsungcsportal.com">gspn2.samsungcsportal.com</a>
North & Latin America	<a href="http://gspn3.samsungcsportal.com">gspn3.samsungcsportal.com</a>
China	<a href="http://china.samsungportal.com">china.samsungportal.com</a>

This Service Manual is a property of Samsung Electronics Co., Ltd.  
Any unauthorized use of Manual can be punished under  
applicable International and/or domestic law.

© Samsung Electronics Co., Ltd. January. 2022.  
Printed in Korea.  
Code No. AC-00286E\_2