

SAMSUNG

MULTI AIR CONDITIONER

INDOOR UNIT

AR07/09/12/15/18/24TSFABWKN
AR07/09/12/15/18/24TSFYBWKN
AJ009/012/018TNNDCH
AJ009/012/018TNLDCH
AJ009/012/015/018TNJDCH

OUTDOOR UNIT

AJ020TXJ2CH
AJ024TXJ3CH
AJ036TXJ4CH
AJ048TXJ5CH
AJ020TXS3CH
AJ024TXS4CH
AJ030TXS4CH
AJ036TXS4CH

SERVICE Manual

AIR CONDITIONER



CONTENTS

1. Precautions
2. Product Specifications
3. Disassembly and Reassembly
4. Troubleshooting
5. PCB Diagram
6. Wiring Diagram
7. Reference Sheet

Contents

1. Precautions	1-1
1-1 Precautions for the Service.....	1-1
1-2 Precautions for the Static Electricity and PL.....	1-1
1-3 During operation.....	1-2
1-4 Disposing of the unit.....	1-2
1-5 Precautions for the Pump Down.....	1-2
1-6 Others.....	1-2
2. Product Specifications	2-1
2-1 The Feature of Product.....	2-1
2-1-1 Features.....	2-1
2-2 Product Specifications.....	2-3
2-2-1 Indoor Unit.....	2-3
2-2-2 Outdoor Unit.....	2-5
2-3 The Comparative Specifications of Product.....	2-7
2-4 Combination Table (Outdoor-Indoor).....	2-9
2-5 Accessory and Option Specifications.....	2-11
2-5-1 Indoor Unit Accessories.....	2-11
2-5-2 Outdoor Unit Accessories.....	2-13
3. Disassembly and Reassembly	3-1
3-1 Outdoor Unit.....	3-2
3-1-1 AJ020TXJ3CH, AJ024TXJ3CH.....	3-2
3-1-2 AJ036TXJ4CH, AJ020TXS3CH, AJ024TXS4CH, AJ030TXS4CH.....	3-5
3-1-3 AJ048TXJ5CH, AJ036TXS4CH.....	3-12
4. Troubleshooting	4-1
4-1 Display and Check Method.....	4-1
4-1-1 Indoor unit.....	4-1
4-1-2 Outdoor Unit.....	4-4
4-2 Setting an indoor unit address and installation option.....	4-6
4-3 Setting Option.....	4-9
4-3-1 Setting Option.....	4-10
4-3-2 The procedure of setting option.....	4-10
4-3-3 Setting an indoor unit address (MAIN/RMC).....	4-12
4-3-4 Setting an indoor unit installation option (suitable for the condition of each installation location).....	4-13
4-3-5 Changing the addresses and option individually.....	4-17
4-3-6 Changing a particular option.....	4-18
4-4 Items to be checked first.....	4-20

Contents

4-5 Setting to Cool or Heat only mode, checking and Cool/Heat modes operation test	4-25
4-6 Fault Diagnosis by Symptom	4-27
4-6-1 Indoor.....	4-27
4-6-2 Outdoor unit is not powered on – Initial diagnosis	4-31
4-6-3 Checking Outdoor Controller	4-32
4-6-4 Outdoor unit fan error.....	4-33
4-6-5 Compressor startup error, Compressor lock error, Compressor rotation error	4-34
4-6-6 IPM Over current error.....	4-35
4-6-7 Checking Temperature sensor.....	4-36
4-7 PCB Inspection	4-38
4-7-1 Cautions for Part Replacement	4-38
4-7-2 Procedure.....	4-38
5. PCB Diagram	5-1
5-1 Indoor unit.....	5-1
5-2 Outdoor PCB Diagram	5-8
6. Wiring Diagram	6-1
6-1 Indoor Unit	6-1
6-2 Outdoor unit	6-4
7. Preference Sheet.....	7-1
7-1 Selecting Area for Installation	7-1
7-1-1 Indoor Unit	7-1
7-1-2 Outdoor Unit.....	7-2
7-1-3 Remote Control Unit.....	7-2
7-2 Connecting Up and Purging the Circuit.....	7-3
7-3 Refrigerant Refill.....	7-4
7-4 Refrigerant Adjustment	7-5
7-5 Flare Nut Fixing Torque	7-5
7-6 "Pump down" Procedure	7-6
7-7 Index of Model Name	7-7
7-8 Refrigerating Cycle Diagram	7-10
7-9 Pressure & Capacity mark	7-14
7-10 The abbreviated technology words & the definition of technology terms	7-14
7-11 Q & A for Non-trouble	7-15
7-12 Common sense of refrigeration	7-18

1. Precautions

1-1 Precautions for the Service

- Users should not install the air conditioner by themselves. Ask the dealer or authorized company to install the air conditioner except the window-type air conditioner in U.S.A and Canada.
- If you don't install the air conditioner properly, it may cause a fire, a water leakage or an electric shock.
- You must install the air conditioner according to the national wiring regulations and safety regulations.
- Install the indoor unit higher than 2.5m from the floor to avoid the injury caused by the operation of the fan. (except the window-type air conditioner)
- The manufacturer is not responsible for any accidents or injury caused by an incorrect installation. When installing the built-in type air conditioner, keep all electric cables such as the power cable and the connection cord in pipes, ducts, or cable channels to protect them from the danger of impact or any other incidents.
- More than 2 indoor units should be installed when you use Free Joint Multi air conditioner.
- **AJ020TX**CH outdoor unit**
 - AR18/24TSF*BWKN, AJ018TNNDCH, AJ018TNLDCH, AJ018TNJDCH indoor units cannot be connected
- **AJ024TXJ3CH outdoor unit**
 - AR24TSF*BWKN indoor units cannot be connected
- **AJ024TXS4CH outdoor unit**
 - AR24TSF*BWKN, AJ018TNJDCH indoor units cannot be connected

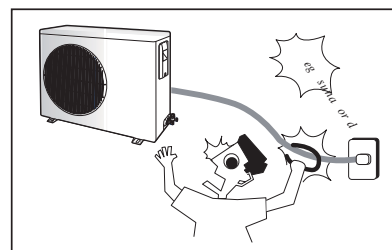

Avoid Dangerous Contact

1-2 Precautions for the Static Electricity and PL

- If the power cord of the air conditioner is damaged, it must be replaced by the manufacturer or a qualified person in order to avoid a hazard.
- The air conditioner must be plugged into an independent circuit if applicable or connect the power cable to the auxiliary circuit breaker. An all pole disconnection from the power supply must be incorporated in the fixed wiring with a contact opening of >3mm.
- Do not extend an electric cord to the air conditioner.
- The air conditioner must be plugged in after you complete the installation.

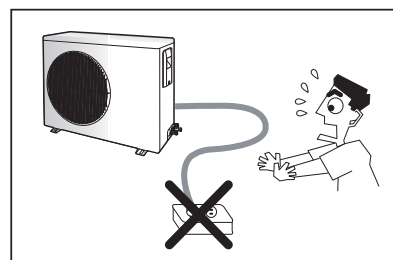

No Tapping and No Extension Cords

1-3 During operation

- Do not repair the air conditioner at your discretion. It is recommended to contact a service center directly.
- Never spill any kind of liquid on the air conditioner. If this happens, turn off the air conditioner and contact an authorized service center.
- Do not insert anything between the airflow blades to prevent damage of the inner fan and consequent injury. Keep children away from the air conditioner.
- Do not place any obstacles in front of the air conditioner.
- Do not spray any kind of liquid into the indoor unit. If this happens, turn off the air conditioner and contact a service center.
- Make sure that the air conditioner is well ventilated at all times: Do not place a cloth or other materials over it.
- Remove the batteries if you don't use the remote control for a long time. (If applicable)
- Use the remote control within 7 meters from the indoor unit. (If applicable)

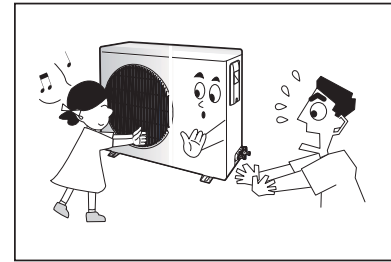

No children Nearby

1-4 Disposing of the unit

- Before throwing out the air conditioner, remove the batteries from the remote control.
- When you dispose of the air conditioner, consult your dealer. If pipes are removed incorrectly, refrigerant may blow out and cause air pollution. When it contacts with your skin, it can cause skin injury.
- The package of the air conditioner should be recycled or disposed of properly for environmental reasons.

1-5 Precautions for the Pump Down

- The pipes should have no leaks during installation, and the compressor must be stopped before removing connecting pipes for pump down work. Operating the compressor while the service valve is open and coolant pipe is not properly connected may cause explosion or injury due to abnormal high pressure created inside the coolant cycle as the air can be absorbed through the pipe.
- Pump Down work procedure (When uninstalling the product)
 - Turn on the air conditioner, select cooling operation, and run the compressor for more than 5 minutes.
 - Release the high pressure and low pressure valve caps.
 - Close the high pressure valve completely using an L-wrench.
 - After about 2 minutes, close the low pressure valve completely.

1-6 Others

- Never store or load the air conditioner upside down or sideways to prevent the damage to the compressor.
- Young children or infirm persons should be always supervised when they use the air conditioner.
- Max current is measured according to IEC standard for safety.
- Current is measured according to ISO standard for energy efficiency.
- For servicing the units containing flammable refrigerants, safety checks are required to minimise the risk of ignition.
- Servicing shall be performed following the controlled procedure to minimize the risk of flammable refrigerant or gases.
- For servicing with handling the R-32 refrigerant, use the special tools for the R32 refrigerant (manifold gauge, vacuu pump, charging hose, etc.).

2. Product Specifications

2-1 The Feature of Product

2-1-1 Features

■ FJM (Free Joint Multi)

The simpler design of the outdoor unit uses space more efficiently.

■ Universal Connection

Multi Inverter(Free Joint Multi) Series delivers comfort to 2~5 rooms with a Single Outdoor Unit.
Free Joint Multi added Universal indoor units, which can be universally connected to other Samsung outdoor units, to all lineup.

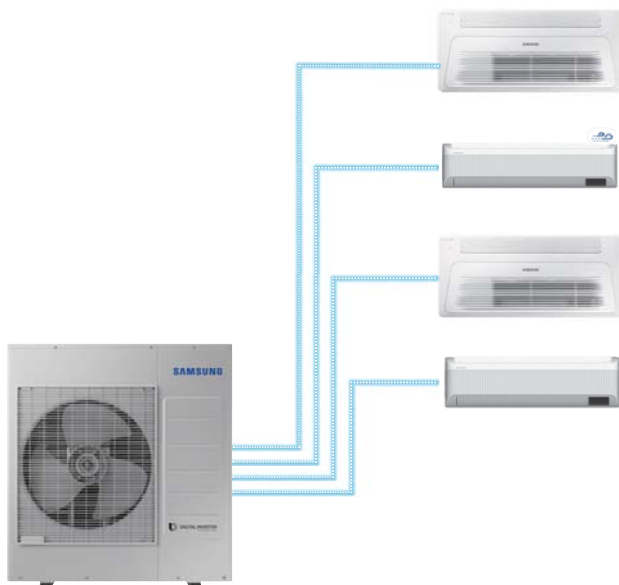

■ Various Indoor units & combinations

- QMD Wind-Free
- QMD Normal
- Wind-Free Mini 4way Cassette
- Home Duct
- Console

■ Auto Addressing & Auto Pipe Inspection

Improved Installation Procedure

- It can automatically set the address of the indoor unit and inspect pipes with one push of the button. Installation is very simple.

▼ AJ020TXJ2CH/AJ024TXJ3CH



▼ AJ036TXJ4CH/AJ048TXJ5CH/AJ020TXS3CH/
AJ024TXS4CH/AJ030TXS4CH/AJ036TXS4CH



■ Setting to Cool or Heat only mode

This function enables the indoor units connected to the outdoor unit to operate in a specific mode. When you want to operate all indoor units with the cooling mode or heating mode.

■ Wi-Fi Function (SmartThings app)

SmartThings app is the easy way to turn your home into a smart home. Control the FJM with only one application. This feature is optional to the several models.

2-2 Product Specifications

2-2-1 Indoor Unit

Type				Cassette		
Model				Mini 4Way		
				AJ009TNNDCH	AJ012TNNDCH	AJ018TNNDCH
Performance	Capacity	Cooling	Btu/h	8900	11900	17700
		Heating		9900	13000	19100
	Noise	High/Mid/Low	dB(A)	33/29/24	35/31/27	39/36/32
Power	Power		ϕ ,V,Hz	1,208-230, 60	1,208-230, 60	1,208-230, 60
	Power Consumption	Cooling	W	19.0	22.0	28.0
		Heating		19.0	22.0	28.0
	Operating Current	Cooling	A	0.51	0.52	0.53
		Heating		0.51	0.52	0.53
Size	Net Size	W*H*D	mm	575*250*575	575*250*575	575*250*575
	Net Weight		kg	11.5	11.5	11.8
	Panel Size	W*H*D	mm	670*45*670	670*45*670	670*45*670
	Panel Weight		kg	2.6	2.6	2.6
Part	Refrigerant Pipe	Liquid	mm	6.35	6.35	6.35
		Gas		9.52	9.52	12.7
	Fan	Type	-	Turbo Fan	Turbo Fan	Turbo Fan
	Fan Motor	Type	-	BLDC	BLDC	BLDC
		Code	-	DB31-00578C	DB31-00578C	DB31-00578C
	Heat Exchanger		Row, Step	2R*8S	2R*8S	2R*10S
	Refrigerant Control Device		-	EEV NOT INCLUDED	EEV NOT INCLUDED	EEV NOT INCLUDED

Type				Duct		
Model				Home Duct		
				AJ009TNLDCH	AJ012TNLDCH	AJ018TNLDCH
Performance	Capacity	Cooling	Btu/h	8900	11900	17700
		Heating		9900	13000	19100
	Noise	High/Mid/Low	dB(A)	28/25/23	30/25/23	33/29/23
Power	Power		ϕ ,V,Hz	1,208-230, 60	1,208-230, 60	1,208-230, 60
	Power Consumption	Cooling	W	50.0	50.0	50.0
		Heating		50.0	50.0	50.0
	Operating Current	Cooling	A	0.45	0.45	0.45
		Heating		0.45	0.45	0.45
Size	Net Size	W*H*D	mm	900 x 199 x 440	900 x 199 x 440	900 x 199 x 440
	Net Weight		kg	18.9	18.9	18.9
	Refrigerant Pipe	Liquid	mm	6.35	6.35	6.35
		Gas		9.52	9.52	12.7
Part	Fan	Type	-	Cross Flow Fan	Cross Flow Fan	Cross Flow Fan
	Fan Motor	Type	-	BLDC	BLDC	BLDC
		Code	-	DB61-00671A	DB61-00671A	DB61-00671A
	Heat Exchanger		Row, Step	2R*10S	2R*10S	2R*10S
Refrigerant Control Device		-	EEV NOT INCLUDED	EEV NOT INCLUDED	EEV NOT INCLUDED	

















Type				Floor Standing			
Model				Console			
				AJ009TNJDCH	AJ012TNJDCH	AJ015TNJDCH	AJ018TNJDCH
Performance	Capacity	Cooling	Btu/h	8900	11900	15000	17700
		Heating		9900	13000	18000	19100
	Noise	Cooling	dB(A)	41	42	47	47
		Heating		43	44	49	49
Power	Power		Φ,V,Hz	1,208-230, 60	1,208-230, 60	1,208-230, 60	1,208-230, 60
	Power Consumption	Cooling	W	30.0	35.0	50.0	50
		Heating		30.0	35.0	50.0	50
	Operating Current	Cooling	A	0.25	0.29	0.35	0.35
Heating		0.25		0.29	0.35	0.35	
Size	Net Size	W*H*D	mm	720*620*199	720*620*199	720*620*199	720*620*199
	Net Weight		kg	15.7	15.7	15.7	15.7
Part	Refrigerant Pipe	Liquid	mm	6.35	6.35	6.35	6.35
		Gas		9.52	9.52	12.7	12.7
	Fan	Type	-	Cross Flow Fan	Cross Flow Fan	Cross Flow Fan	Cross Flow Fan
	Fan Motor	Type	-	BLDC	BLDC	BLDC	BLDC
		Code	-	DB31-00517A	DB31-00517A	DB31-00517A	DB31-00517A
	Heat Exchanger		Row, Step		2R*20S	2R*20S	2R*20S
Refrigerant Control Device		-		EEV NOT INCLUDED	EEV NOT INCLUDED	EEV NOT INCLUDED	EEV NOT INCLUDED

2-2-2 Outdoor Unit













Type				Free Joint Multi			
Model				AJ020TXJ2CH/AA	AJ024TXJ3CH/AA	AJ036TXJ4CH/AA	AJ048TXJ5CH/AA
Performance	Capacity	Cooling	Btu/h	18000	22000	32000	47000
		Heating		22000	25000	36000	48500
	Noise	Sound Pressure	dB(A)	48.0	48.0	54.0	52.0
Power	Power		Φ,V,Hz	1,208-230, 60	1,208-230, 60	1,208-230, 60	1,208-230, 60
	Power Consumption	Cooling	W	1410	1730	2560	4470
		Heating		1730	1780	2830	3790
	Operating Current	Cooling	A	6.4	7.9	11.7	20.5
		Heating		7.8	8.1	12.9	16.9
Size	Net Size	W*H*D	mm	880 x 798 x 310	880 x 798 x 310	940 x 998 x 330	940 x 1,210 x 330
	Net Weight		kg	53.0	57.0	76.5	90.5
Part	Refrigerant Pipe	Liquid	mm	6.35*2	6.35*3	6.35*4	6.35*5
		Gas		9.52*2	9.52*2+12.7*1	9.52*2+12.7*2	9.52*2+12.7*3
	Compressor	Type	-	Twin BLDC Rotary	BLDC Rotary	Twin BLDC Rotary	Twin BLDC Rotary
		Model Name	-	UG4T200FUAE4	G8T260FUAEW	KTF310D43UMT	KTF310D43UMT
		Output	kW	5.919	7.766	10.01	10.01
	Fan Motor	Type	-	BLDC	BLDC	BLDC	BLDC
		Code	-	DB31-00579A	DB31-00579A	DB31-00579A	DB31-00579A
	Heat Exchanger		Row, Step	2R*36S	2R*36S	2R*46S	2R*56S
Refrigerant Control Device		-	EEV	EEV	EEV	EEV	
Refrigerant	Type		-	R-410A	R-410A	R-410A	R-410A
	Factory Charging		g	2200	2650	3100	3800

Type				Free Joint Multi			
Model				AJ020TXS3CH/AA	AJ024TXS3CH/AA	AJ030TXS4CH/AA	AJ036TXS4CH/AA
Performance	Capacity	Cooling	Btu/h	21000	25000	28400	34000
		Heating		22000	25000	28600	36600
	Noise	Sound Pressure	dB(A)	54.0	54.0	54.0	52.0
Power	Power		Φ,V,Hz	1,208-230, 60	1,208-230, 60	1,208-230, 60	1,208-230, 60
	Power Consumption	Cooling	W	1550	1920	2270	2720
		Heating		1620	1840	2100	2520
	Operating Current	Cooling	A	6.9	8.7	10.2	12.5
		Heating		7.2	8.3	9.5	11.2
Size	Net Size	W*H*D	mm	940 x 998 x 330	940 x 998 x 330	940 x 998 x 330	940 x 1,210 x 330
	Net Weight		kg	76.0	76.5	76.5	90.5
Part	Refrigerant Pipe	Liquid	mm	6.35*3	6.35*4	6.35*4	6.35*4
		Gas		9.52*2+12.7*1	9.52*2+12.7*2	9.52*2+12.7*2	9.52*2+12.7*2
	Compressor	Type	-	Twin BLDC Rotary	Twin BLDC Rotary	Twin BLDC Rotary	Twin BLDC Rotary
		Model Name	-	UG8T300FUBJU	UG8T300FUBJU	UG8T300FUBJU	KTF310D43UMT
		Output	kW	9.171	9.171	9.171	10.01
	Fan Motor	Type	-	BLDC	BLDC	BLDC	BLDC
		Code	-	DB31-00579A	DB31-00579A	DB31-00579A	DB31-00579A
	Heat Exchanger		Row, Step	2R*46S	2R*46S	2R*46S	2R*56S
Refrigerant Control Device		-	EEV	EEV	EEV	EEV	
Refrigerant	Type		-	R-410A	R-410A	R-410A	R-410A
	Factory Charging		g	3400	3400	3400	3600

2-3 The Comparative Specifications of Product

Item		AJ020TXJ2CH		AJ024TXJ3CH		AJ036TXJ4CH		AJ048TXJ5CH		AJ020TXS3CH		AJ024TXS4CH		AJ030TXS4CH		AJ036TXS4CH					
Design	Outdoor Unit																				
	Indoor Unit																				
Net Weighth [kg]	Outdoor Unit	AJ020TXJ2CH	53.0	AJ024TXJ3CH	57.0	AJ036TXJ4CH	76.5	AJ048TXJ5CH	90.5	AJ020TXS3CH	76.0	AJ024TXS4CH	76.5	AJ030TXS4CH	76.5	AJ036TXS4CH	90.5				
	Indoor Unit	AR07/09/12/15TSFABWKN	10.1	AR07/09/12/15TSFABWKN	10.1	AR07/09/12/15TSFABWKN	10.1	AR07/09/12/15TSFABWKN	10.1	AR07/09/12/15TSFABWKN	10.1	AR07/09/12/15TSFABWKN	10.1	AR07/09/12/15TSFABWKN	10.1	AR07/09/12/15TSFABWKN	10.1	AR07/09/12/15TSFABWKN	10.1		
					AR18TSFABWKN	12.5	AR18TSFABWKN	12.5	AR18TSFABWKN	12.5			AR18TSFABWKN	12.5	AR18TSFABWKN	12.5	AR18TSFABWKN	12.5	AR18TSFABWKN	12.5	
							AR24TSFABWKN	12.5	AR24TSFABWKN	12.5					AR24TSFABWKN	12.5	AR24TSFABWKN	12.5	AR24TSFABWKN	12.5	
		AR07/09/12/15TSFYBWKN	9.2	AR07/09/12/15TSFYBWKN	9.2	AR07/09/12/15TSFYBWKN	9.2	AR07/09/12/15TSFYBWKN	9.2	AR07/09/12/15TSFYBWKN	9.2	AR07/09/12/15TSFYBWKN	9.2	AR07/09/12/15TSFYBWKN	9.2	AR07/09/12/15TSFYBWKN	9.2	AR07/09/12/15TSFYBWKN	9.2		
					AR18TSFYABWKN	11.5	AR18TSFYABWKN	11.5	AR18TSFYABWKN	11.5			AR18TSFYABWKN	11.5	AR18TSFYABWKN	11.5	AR18TSFYABWKN	11.5	AR18TSFYABWKN	11.5	
							AR24TSFYABWKN	11.5	AR24TSFYABWKN	11.5					AR24TSFYABWKN	11.5	AR24TSFYABWKN	11.5	AR24TSFYABWKN	11.5	
		AJ009/012TNNDCH	11.5	AJ009/012TNNDCH	11.5	AJ009/012TNNDCH	11.5	AJ009/012TNNDCH	11.5	AJ009/012TNNDCH	11.5	AJ009/012TNNDCH	11.5	AJ009/012TNNDCH	11.5	AJ009/012TNNDCH	11.5	AJ009/012TNNDCH	11.5	AJ009/012TNNDCH	11.5
					AJ018TNNDCH	11.8	AJ018TNNDCH	11.8	AJ018TNNDCH	11.8			AJ018TNNDCH	11.8	AJ018TNNDCH	11.8	AJ018TNNDCH	11.8	AJ018TNNDCH	11.8	
		AJ009/012TNLDCH	18.9	AJ009/012TNLDCH	18.9	AJ009/012TNLDCH	18.9	AJ009/012TNLDCH	18.9	AJ009/012TNLDCH	18.9	AJ009/012TNLDCH	18.9	AJ009/012TNLDCH	18.9	AJ009/012TNLDCH	18.9	AJ009/012TNLDCH	18.9	AJ009/012TNLDCH	18.9
					AJ018TNLDCH	18.9	AJ018TNLDCH	18.9	AJ018TNLDCH	18.9			AJ018TNLDCH	18.9	AJ018TNLDCH	18.9	AJ018TNLDCH	18.9	AJ018TNLDCH	18.9	
	AJ009/012TNJDCH	15.7	AJ009/012TNJDCH	15.7	AJ009/012TNJDCH	15.7	AJ009/012TNJDCH	15.7	AJ009/012TNJDCH	15.7	AJ009/012TNJDCH	15.7	AJ009/012TNJDCH	15.7	AJ009/012TNJDCH	15.7	AJ009/012TNJDCH	15.7	AJ009/012TNJDCH	15.7	
			AJ015TNJDCH	15.7	AJ015TNJDCH	15.7	AJ015TNJDCH	15.7	AJ015TNJDCH	15.7	AJ015TNJDCH	15.7	AJ015TNJDCH	15.7	AJ015TNJDCH	15.7	AJ015TNJDCH	15.7	AJ015TNJDCH	15.7	
					AJ018TNJDCH	15.7	AJ018TNJDCH	15.7					AJ018TNJDCH	15.7	AJ018TNJDCH	15.7	AJ018TNJDCH	15.7			



2-4 Combination Table (Outdoor-Indoor)

Indoor Unit \ Outdoor Unit		Model	AJ020TXJ2CH	AJ024TXJ3CH	AJ036TXJ4CH	AJ048TXJ5CH	AJ020TXS3CH	AJ024TXS4CH	AJ030TXS4CH	AJ036TXS4CH	
											
Model		Capacity	20K	24K	36K	48K	20K	24K	30K	36K	
	AR07/09/12/15/18/24TSFABWKN	7 Kbtu	●	●	●	●	●	●	●	●	
		9 Kbtu	●	●	●	●	●	●	●	●	
		12 Kbtu	●	●	●	●	●	●	●	●	
		15 Kbtu	●	●	●	●	●	●	●	●	
		18 Kbtu		●	●	●	●		●	●	●
		24 Kbtu			●	●	●			●	●
	AR07/09/12/15/18/24TSFYBWKN	7 Kbtu	●	●	●	●	●	●	●	●	
		9 Kbtu	●	●	●	●	●	●	●	●	
		12 Kbtu	●	●	●	●	●	●	●	●	
		15 Kbtu	●	●	●	●	●	●	●	●	
		18 Kbtu		●	●	●	●		●	●	●
		24 Kbtu			●	●	●			●	●
	AJ009/012/018TNNDC	9 Kbtu	●	●	●	●	●	●	●	●	
		12 Kbtu	●	●	●	●	●	●	●	●	
		18 Kbtu		●	●	●		●	●	●	
	AJ009/012/018TNLDCH	9 Kbtu	●	●	●	●	●	●	●	●	
		12 Kbtu	●	●	●	●	●	●	●	●	
		18 Kbtu		●	●	●		●	●	●	
	AJ009/012/015/018TNJDCH	9 Kbtu	●	●	●	●	●	●	●	●	
		12 Kbtu	●	●	●	●	●	●	●	●	
		15 Kbtu	●	●	●	●	●	●	●	●	
		18 Kbtu		●	●	●			●	●	

2-5 Accessory and Option Specifications



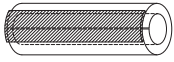
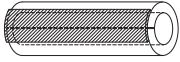

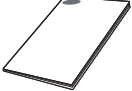

2-5-1 Indoor Unit Accessories

■ Mini 4Way

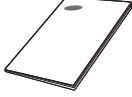
Item	Descriptions	Code No.	Q'ty	Remark
	Ass'y drain hose Joint	DB94-03287A	1	Indoor Unit
	Cable-tie	DB65-10088C	6	
	Insulation-Drain Hose L220mm, ID45mm	DB62-11028A	1	
	Insulation-Drain Hose L150mm, ID30mm	DB62-11028H	1	
	Insulation-Drain Hose L200mm, ID55mm	DB62-11028J	1	
	User Manual	DB68-08738A	1	
	Installation Manual	DB68-08734A	1	

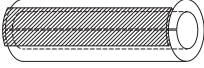
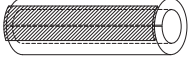
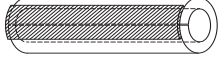
* The design and shape can be changed according to the model.

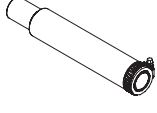





■ Home Duct

Item	Descriptions	Code No.	Q'ty	Remark
	User Manual	DB68-08740A	1	Indoor Unit
	Installation Manual	DB68-08736A	1	
	Insulation-Drain Hose	DB62-11028A L220mm, ID45mm	1	
	Insulation-Drain Hose	DB62-11028F L200mm, ID35mm	1	
	Insulation-Drain Hose	DB62-11028E L200mm, ID35mm	4	
	Rubber (Grommet Hanger)	DB63-00237A	8	
	Insulation-Drain	DB62-04318S	1	
	Ass'y Drain Hose Joint	DB94-06964B	1	
	Cable-Tie	DB65-10088C	8	

※ The design and shape can be changed according to the model.

2-5-2 Outdoor Unit Accessories



■ AJ***TX**CH

Item	Descriptions	Code No.	Q'ty	Remark
	Drain Plug	DB67-00477A (AJ020TXJ2CH, AJ024TXJ3CH)	1	
		DB67-00806A (AJ036TXJ4CH, AJ048TXJ5CH, AJ***TXS*CH)		
	Rubber Leg	DB73-20134A	4	
	Installation Manual	DB68-08737A (AJ020TXJ2CH, AJ024TXJ3CH)	1	
		DB68-08940A (AJ036TXJ4CH, AJ048TXJ5CH, AJ***TXS*CH)		
	Nipple Connector	DB67-00789A	1 (AJ020TXJ2CH) 2 (AJ024TXJ3CH)	12.7mm → 9.52mm
	Flare Nuts	DB60-30010B	1 (AJ020TXJ2CH) 2 (AJ024TXJ3CH)	12.7mm → 9.52mm
	Ass'y Tube Connector	DB96-16155A	2 (AJ***TX*4CH) 3 (AJ***TX*5CH)	12.7mm → 9.52mm
		DB96-16155B	2 (AJ020TXS3CH, AJ***TX*4CH, AJ***TX*5CH)	12.7mm → 15.88mm

* The design and shape can be changed according to the model.

3. Disassembly and Reassembly

■ Necessary Tools



Item	Remark
+Screw driver	
Monkey spanner	

3-1 Outdoor Unit

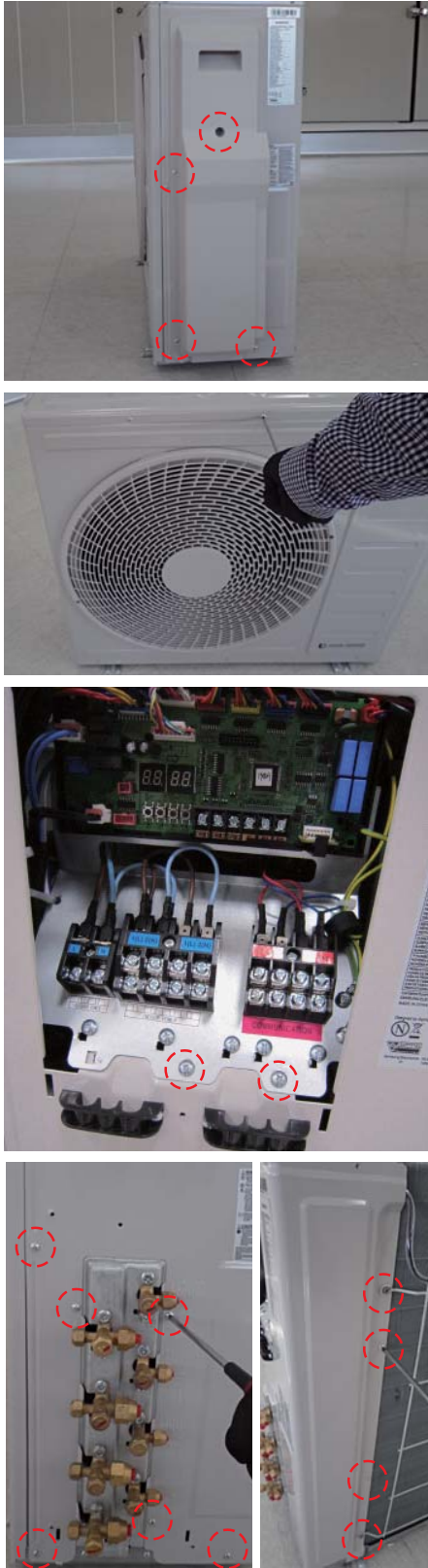

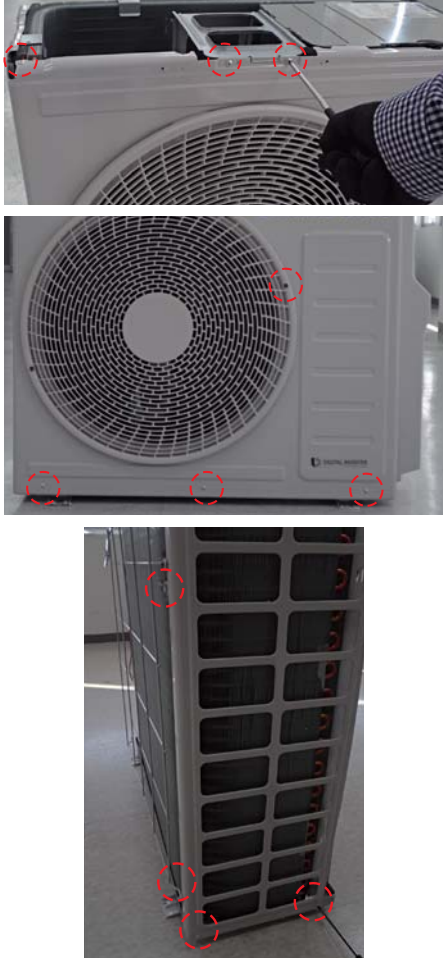
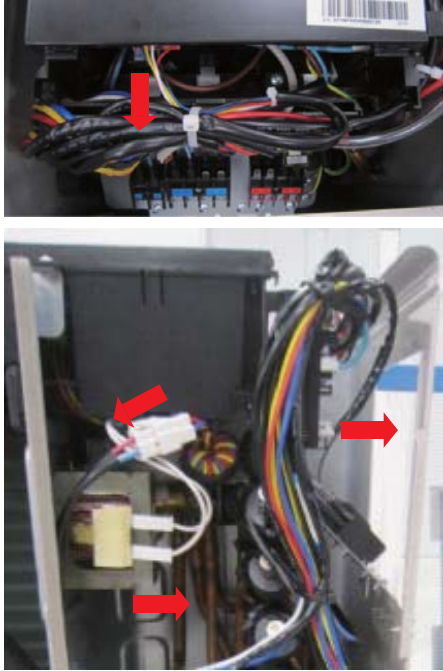
3-1-1 AJ020TXJ3CH, AJ024TXJ3CH

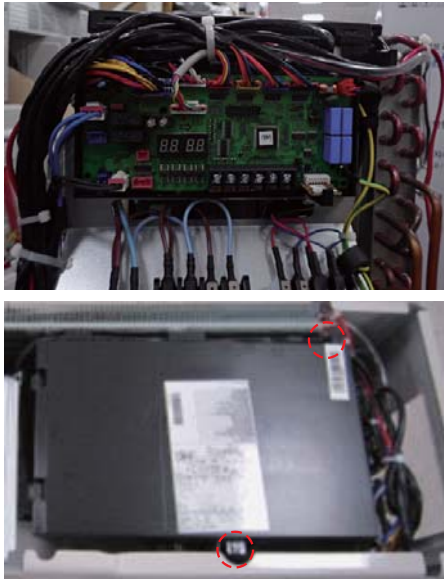

No	Parts	Procedure	Remark
1	Common Work & Control Out	<p>⚠ You must turn off the Power before disassembly.</p> <p>1) Loosen 4 fixing screws(CCW) of the Cover-Valve. (Use +Screw Driver).</p> <p>2) Loosen each 9 screws(CCW) on Cabi-Top. (Use +Screw Driver).</p> <p>3) Loosen 2 screws(CCW) fixed to assemble Plate Control Out with Cabinet-Side RH. (Use +Screw Driver).</p> <p>4) Loosen 10 fixing screws(CCW) on Cabinet-Side RH. (Use +Screw Driver.)</p>	

No	Parts	Procedure	Remark
		<p>5) Loosen each 7 screws (CCW) on Cabinet Front. (Use +Screw Driver.)</p> <p>6) Loosen each 4 screws (CCW) on Cabinet-Side LF. (Use +Screw Driver.)</p>	
2	Ass'y Control Out	<p>1) Detach the Motor Wire from the PCB of Ass'y Control Out.</p> <p>2) Detach comp wire and pressure switch-wire from the PCB of Ass'y Control Out.</p> <p>3) Detach 2 Connect Wires from Reactor.</p>	





No	Parts	Procedure	Remark
		4) Detach several connectors from the PCB of Ass'y Control Out. 5) Loosen 2 screws (CCW) fixed to assemble Ass'y Control Out with Partition. (Use +Screw Driver.)	
3	Fan & Motor	1) Loosen the fixing nut (CW) and detach the Fan. (Use Monkey Spanner.) 2) Loosen 4 fixing bolts and detach the Motor. (Use +Screw Driver.) 3) Loosen 2 fixing screws and detach the Bracket Motor. (Use +Screw Driver.)	
4	Heat Exchanger & Compressor	1) Release the refrigerant at first. 2) Disassemble the Inlet and Outlet Pipe by welding. 3) Loosen the fixing 3 screws of the Heat Exchanger. (Use +Screw Driver.) 4) Detach the Heat Exchanger. ⚠ Befor you disassemble the pipes and Condensor, be sure that there should be no refrgerant remained in the unit. 5) Loosen 3 nuts of the Compressor. (Use Monkey Spanner.) 6) Detach the Compressor.	

3-1-2 AJ036TXJ4CH, AJ020TXS3CH, AJ024TXS4CH, AJ030TXS4CH

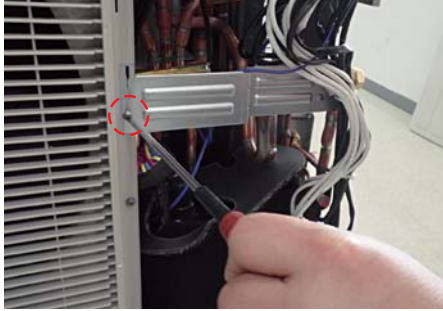
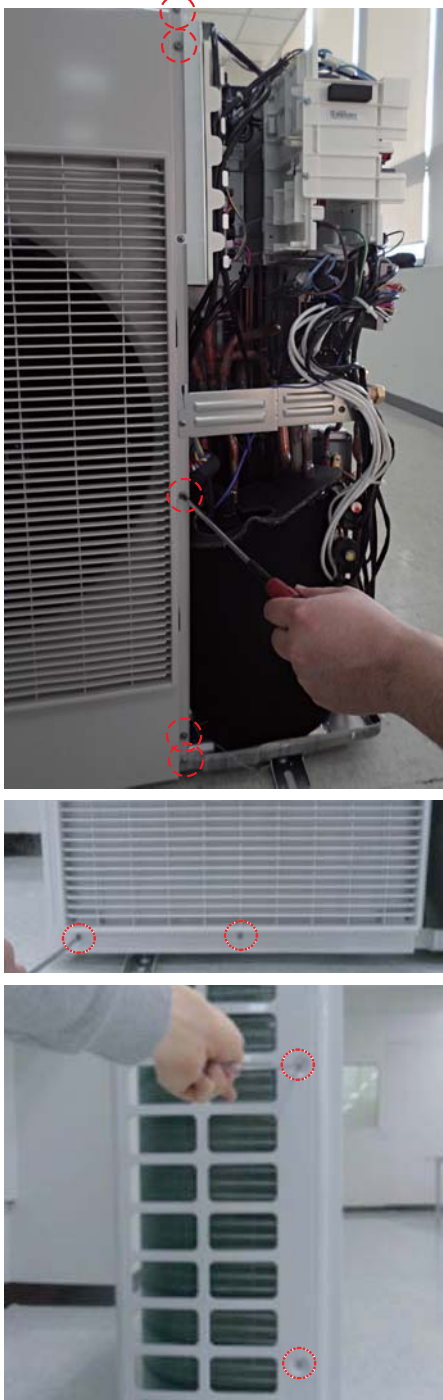

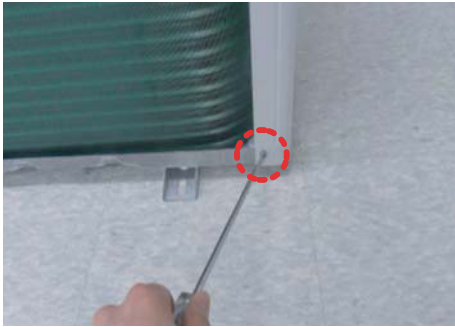
No	Parts	Procedure	Remark
1	Cabi side RH	<p>⚠ You must turn off the Power before disassembly.</p> <p>1) Loosen 6 fixing screws (CCW) on the Cabinet-Side RH. (Use +Screw Driver).</p>	
2	Cabi Front RH	<p>1) Loosen 3 fixing screws (CCW) on the Cabinet-Front RH. (Use +Screw Driver).</p>	
3	Cabi Top	<p>1) Loosen 7 or 9 fixing screws (CCW) on the Cabi-Top. (Use +Screw Driver).</p>	

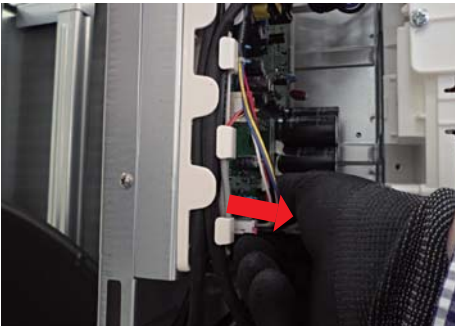



No	Parts	Procedure	Remark
4	Guard Cond	<p>1) Detach the Sensor from the Guard Cond.</p> <p>2) Loosen 4 fixing screws (CCW) on the Gurad Cond. (Use +Screw Driver).</p>	
5	Cabi Back RH	<p>1) Detach the Sensor from the Cabi-Back RH.</p> <p>2) Loosen 5 fixing screws (CCW) on Cabi-Back RH. (Use +Screw Driver).</p> <p>3) Pull the hook of Cabi Back RH from the Bracket Valve.</p>	

No	Parts	Procedure	Remark
6	Plate Case Control Support	1) Loosen 2 fixing screws (CCW) on the Plate Case Control Support. (Use +Screw Driver).	
7	Cabi Front LF	1) Loosen 10 fixing screws (CCW) on the Cabinet-Front LF. (Use +Screw Driver).	



No	Parts	Procedure	Remark
			
8	Fan	<ol style="list-style-type: none"> 1) Loosen the fixing nut (CW). (Use Monkey Spanner) 2) Detache the fan. 	
9	Motor	<ol style="list-style-type: none"> 1) Detach the Motor Wire from PCB of A'ssy Control Out. 2) Loosen 4 fixing bolts (CCW) and detach the Motor. (Use +Screw Driver.) 	 
10	Bracket Motor	<ol style="list-style-type: none"> 1) Loosen 2 fixing screws (CCW) and detach the Bracket Motor. (Use +Screw Driver.) 	



No	Parts	Procedure	Remark
11	Control Out	<p>1) Detach Comp-Wire and Pressure-Wire from PCB of A'ssy Control Out.</p> <p>2) Loosen 4 fixing screws (CCW) and detach the Bracket Motor. (Use +Screw Driver.)</p> <p>3) Separate A'ssy Control Out.</p>	

No	Parts	Procedure	Remark
12	Ass'y 4way Valve	1) Disassemble the pipes in both inlet and outlet with welding torch. ⚠ Before you disassemble the pipes and Condenser, be sure that there should be no refrigerant remained in the unit.	
13	Assy EEV Valve	1) Disassemble the pipes in both inlet and outlet with welding torch. 2) Loosen 2 fixing screws (CCW) and detach the Bracket Valve. (Use +Screw Driver.)	
14	Compressor	1) Loosen fixing nut (CCW) on the Cover-Terminal. (Use Monkey Spanner or adjustable Wrench.)	

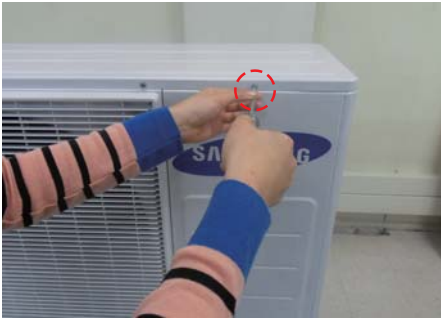
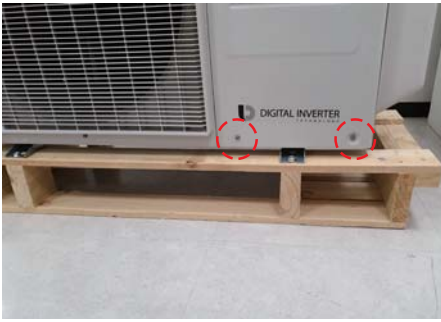

No	Parts	Procedure	Remark
		<p>2) Separate the Compressor Felt Sound.</p> <p>3) Loosen 3 nuts (CCW) at the bottom of Compressor. (Use Monkey Spanner.)</p> <p>⚠ When assembling Comp Wire, make sure to match the color and location of the wire with the picture.</p>	 
15	Heat Exchanger	<p>1) Loosen 2 fixing screws(CCW) on both sides. And loosen 1 fixed screws(CCW) Partition with base.(Use +Screw Driver.)</p>	  

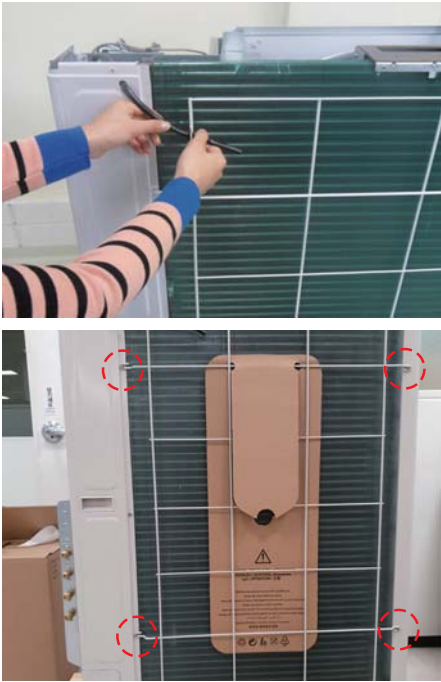
3-1-3 AJ048TXJ5CH, AJ036TXS4CH

No	Parts	Procedure	Remark
1	Cover valve	<p>⚠ Turn off the power before disassembly necessity.</p> <p>1) Remove the 2 screws from the cover valve and separate it. (Use + Screw Driver)</p>	
2	Cabinet Front RH	<p>2) Remove the 4 screws from the Cabinet Front RH and separate it. (Use + Screw Driver)</p>	 
3	Cabinet Top	<p>1) Remove the 8 screws which is fixed to each side of cabinet top and separate it. (Use + Screw Driver)</p>	

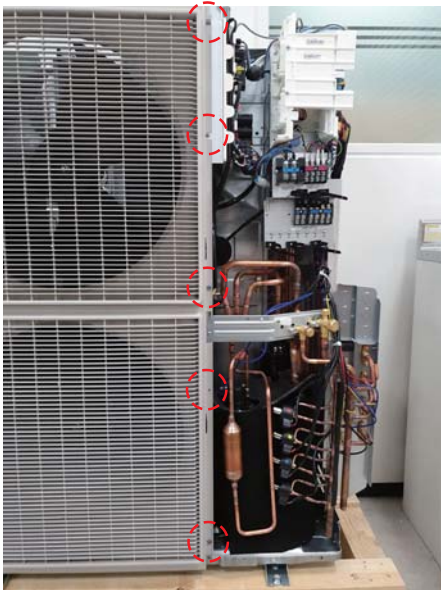
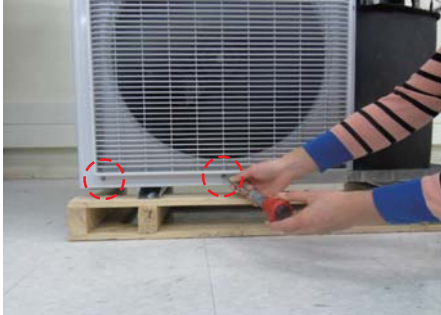
No	Parts	Procedure	Remark
4	Guard Cond	<p>1) Pull out the sensor from the guard cond and separate it.</p> <p>2) Remove the 4 screws which is fixed to guard cond and separate it. (Use + Screw Driver)</p>	
5	Cabinet Back RH	<p>1) Pull out the sensor from the cabinet back RH and separate it.</p> <p>2) Remove the 4 screws which is fixed to each side cabinet back RH and separate it. (Use + Screw Driver)</p>	

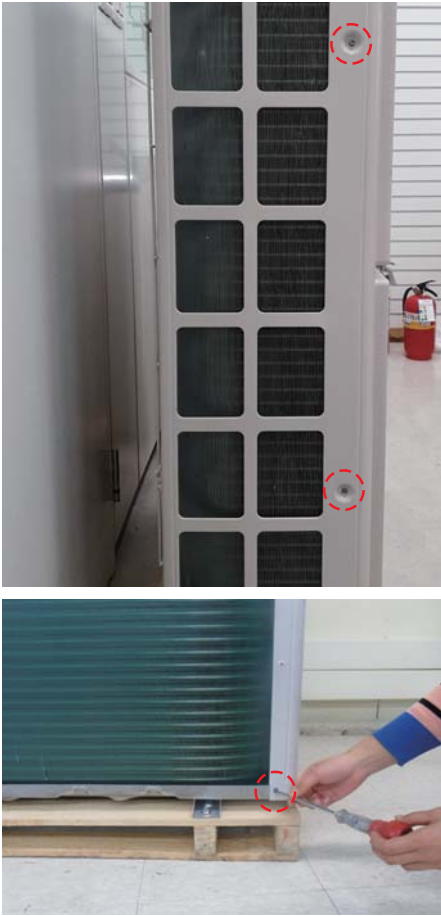
No	Parts	Procedure	Remark
6	Plate Control	1) Remove the 1 screw from the Plate Control and separate it. (Use + Screw Driver)	
7	Cabinet Front LH	1) Remove the 10 screws from the cabinet Front LF and separate it. (Use + Screw Driver)	 

No	Parts	Procedure	Remark
7	Cabinet Front LH		
8	Fan	<p>1) Remove the 2 fixing nuts like the picture on the right side. (Use Hexagon Wrench, Monkey Spanner, Hexagon Socket)</p>	





No	Parts	Procedure	Remark
9	Motor	1) Separate the Fan Propeller. 2) Remove the 8 screws which is fixed to Motor. (Use + Screw Driver) 3) Separate the Motor Wire connector from the Outdoor Unit Control Part.	
10	Bracket Motor	1) Remove the 2 screws from the Bracket Motor and separate it. (Use + Screw Driver)	

4. Troubleshooting

4-1 Display and Check Method

4-1-1 Indoor unit

■ Mini 4way Wind-Free





























Abnormal conditions	LED lamp display			
	Opertion	Defrost	Timer	Filter
				
Power reset	●	x	x	x
Error of tempreature sensor in the indoor unit (Open/Short)	x	●	x	x
Error of heat exchanger sensor in the indoor unit (Open/Short)	●	●	x	x
Error of fan motor in the indoor unit	x	x	●	x
Error of the outdoor temperature sensor Error of the condensor temperature sensor Error of the discharge temperature sensor	●	x	●	x
No communication for 2 minutes between indoor and outdoor unit (communication error for more than 2 minutes)	x	●	●	x
Error of outdoor unit Error of the terminal block thermal fuse (Open)	x	●	●	●
Detection of the float switch	x	x	●	●
EEPROM error EEPROM option error	●	●	●	●
Motion detect sensor error	●	x	x	●
Mixed operatiion error	x	x	x	●
Outdoor valve clogging error	●	x	●	●
Miss matching error between indoor unit and outdoor unit	●	●	x	●

●: On ○: Flickering x: Off

• If you turn off the air conditioner when the LED is flickering, the LED is also turned off.

■ Home Duct

- If an error occurs during the operation, one or more LED flickers and the operation is stopped except the LED.
- If you re-operate the air conditioner, it operates normally at first, then detect an error again.

Abnormal conditions	Indicators					Operating
	Concealed Type 					
	Green	Red				
	Standard Type					
						
Power reset		x	x	x	x	
Error of Room sensor in the indoor unit(Open/Short)	x	x		x	x	
Error of EVA-IN,EVA-OUT sensor in the indoor unit (Open/Short)		x		x	x	
Error of Fan motor in the indoor unit	x	x	x		x	
Error of Outdoor or Terminal Block Thermal Fuse (Open)	x	x				
Clogging of outdoor's service valve		x	x			
Detection of the float switch	x	x	x			
Error of EEPROM or OPTION SETTING						
1. No communication for 2 minutes between indoor units (Communication error for more than 2 minutes) 2. Indoor unit receiving the communication error from outdoor unit 3. Outdoor unit tracking 3 minutes error 4. When sending the communication error from the outdoor unit, the mismatching of the communication numbers and installed numbers after completion of tracking. (Communication error for more than 2 minutes)	x	x			x	1. Indoor unit error (Display is unrelated with operation) 2. Outdoor unit error (Display is unrelated with operation)

●: On ○: Flickering x: Off

- If you turn off the air conditioner when the LED is flickering, the LED is also turned off.

- If an error occurs,  is displayed on the wired remote controller. If you would like to see an error code, press the Test button.

Display	Explanation	Remark
800	Communication Error between indoor and outdoor unit	
820	Error of Room sensor in the indoor unit(Open/Short)	
822	Error of Eva In sensor in the indoor unit(Open/Short)	
823	Error of Eva Out sensor in the indoor unit(Open/Short)	
853	2nd Detection of the float switch	
854	Error of Fan motor in the indoor unit	
862	EEPROM error	
863	EEPROM option setting error	
898	Error of Terminal Block's Thermal Fuse(Open)	
202	No communication for 2minutes between indoor units (Communication error for more than 2minutes)	
422	Clogging of outdoor's service valve	
553	Option code miss matching among the indoors (only for DPM)	Check indoor option code
600	Error of communication down between the indoor unit and wired remote controller after 3minutes.	Wired remote controller error
604	Error of communication down between the indoor unit and wired remote controller after completion of 10 times tracking.	
606	COM1/COM2 Cross-installed error	
607	Error of master wired remote controller and slave wired remote controller setting	

4-1-2 Outdoor Unit

The table below list the self-diagnostic routines. For some of error, you must contact an authorized service center. If an error occurs during the operation, it is displayed on the outdoor unit PCB MAIN-OUT.

■ AJ020TXJ2CH, AJ024TXJ3CH

- PCB MAIN - OUT

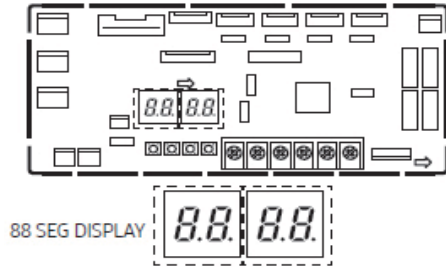

- PCB MAIN – OUT

(AJ020TXS3CH, AJ***TX*4CH, AJ***TX*5CH)



Error Code	Explanation	Remark
E108	ERROR DUE TO REPEATED ADDRESS SETTING(WHEN 2 OR MORE DEVICES HAS THE SAME ADDRESS WITHIN THE NETWORK)	
E190	PIPE CHECK ERROR	
E199	PIPE CHECK OPERATION HAS NOT BEEN COMPLETED	
E201	COMMUNICATION ERROR BETWEEN INDOOR AND OUTDOOR UNIT(INSTALLATION NUMBER SETTING ERROR, REPEATED INDOOR UNIT ADDRESS, INDOOR UNIT COMM)	
E202	COMMUNICATION ERROR BETWEEN INDOOR AND OUTDOOR UNIT(COMMUNICATION ERROR ON ALL INDOOR UNITS, OUTDOOR UNIT COMMUNICATION CABLE ERROR)	
E203	COMMUNICATION ERROR BETWEEN INVERTER PBA AND MAIN PBA	
E221	ERROR ON AMBIENT TEMPERATURE SENSOR (SHORT OR OPEN)	
E237	ERROR ON CONDENSOR TEMPERATURE SENSOR(SHORT OR OPEN)	
E251	ERROR ON DISCHARGE TEMPERATURE SENSOR(SHORT OR OPEN)	
E320	ERROR ON COMPRESSOR OLP TEMPERATURE SENSOR(SHORT OR OPEN)	
E330	ERROR ON PIPE IN-A TEMPERATURE SENSOR(SHORT OR OPEN)	
E331	ERROR ON PIPE IN-B TEMPERATURE SENSOR(SHORT OR OPEN)	
E332	ERROR ON PIPE IN-C TEMPERATURE SENSOR(SHORT OR OPEN)	
E333	ERROR ON PIPE IN-D TEMPERATURE SENSOR(SHORT OR OPEN)	
E334	ERROR ON PIPE IN-E TEMPERATURE SENSOR(SHORT OR OPEN)	

Error Code	Explanation	Remark
E335	ERROR ON PIPE OUT-A TEMPERATURE SENSOR(SHORT OR OPEN)	
E336	ERROR ON PIPE OUT-B TEMPERATURE SENSOR(SHORT OR OPEN)	
E337	ERROR ON PIPE OUT-C TEMPERATURE SENSOR(SHORT OR OPEN)	
E338	ERROR ON PIPE OUT-D TEMPERATURE SENSOR(SHORT OR OPEN)	
E339	ERROR ON PIPE OUT-E TEMPERATURE SENSOR(SHORT OR OPEN)	
E401	OUTDOOR UNIT FREEZING-SAFETY CONTROL(COMPRESSOR STOP)	
E404	OUTDOOR UNIT OVERLOAD-SAFETY CONTROL(COMPRESSOR STOP)	
E416	COMPRESSOR OPERATION STOP DUE TO DISCHARGE TEMPERATURE PROTECTION CONTROL	
E422	HIGH PRESSURE BLOCKAGE CONTROL	
E440	HEATING MODE RESTRICTION DUE TO HIGH AIR TEMPERATURE	
E441	COOLING MODE RESTRICTION DUE TO LOW AIR TEMPERATURE	
E458	FAN MOTOR ERROR	
E461	OPERATION FAILURE OF COMPRESSOR	
E462	COMPRESSOR OPERATION STOP DUE TO FULL LOAD CURRENT CONTROL	
E463	COMPRESSOR OPERATION STOP DUE TO OLP TEMPERATURE CONTROL	
E464	ERROR DUE TO OVER-CURRENT OF COMPRESSOR	
E465	VOLTAGE-LIMIT ERROR OF COMPRESSOR	
E466	ERROR DUE TO LOW/OVER VOLTAGE OF DC LINK IN INVERTER PBA	
E467	ABNORMAL RPM IN COMPRESSOR OR WIRE FOR COMPRESSOR HAS NOT BEEN CONNECTED	
E468	ERROR DUE TO OUTPUT CURRENT SENSOR OF INVERTER PBA(SHORT/OPEN)	
E469	ERROR DUE TO DC LINK VOLTAGE SENSOR OF INVERTER PBA(SHORT/OPEN)	
E470	OUTDOOR UNIT EEPROM READ/WRITE ERROR	
E471	OUTDOOR UNIT EEPROM READ/WRITE ERROR(OTP)	
E474	ERROR ON IPM/PFCM TEMPERATURE SENSOR OF INVERTER PBA(SHORT OR OPEN)	
E475	FAN2 MOTOR ERROR	
E483	OVERVOLTAGE OF H/W DETECT DC LINK	
E484	PFC OVERLOAD(OVER CURRENT) ERROR	
E485	ERROR DUE TO INPUT CURRENT SENSOR OF INVERTER PBA(SHORT/OPEN)	
E488	INCOMING VOLTAGE SENSOR ERROR	
E500	IPM/PFCM OVERHEAT ERROR	
E554	THE REFRIGERANT LEAKS COMPLETELY FROM THE OUTDOOR UNIT	
E563	ERROR DUE TO INDOOR UNIT SOFTWARE VERSION COMBINATION(INCOMPATIBLE INDOOR UNIT SOFTWARE ON A SYSTEM)	
E590	INVERTER EEPROM CHECKSUM ERROR	

4-2 Setting an indoor unit address and installation option

1. Setting the indoor unit addresses automatically



• This product is prohibited one indoor unit installation. Don't use pipe checking operation and auto addressing mode when one indoor unit is installed.

■ AJ020TXJ2CH, AJ024TXJ3CH

- PCB MAIN - OUT

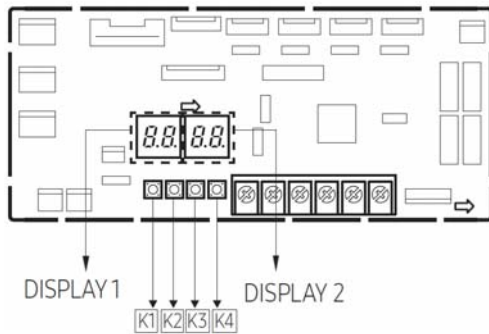

- PCB MAIN - OUT

(AJ020TXS3CH, AJ***TX*4CH, AJ***TX*5CH)



1. Turn on the outdoor unit, and then check whether the display 1/2 indications are displayed "E199" code.
 - ※ During the initial, display 1 shows "Ad" and display 2 shows the connected indoor number.
 - If different display code is shown, see Troubleshooting on page 40 and take corrective actions.
2. Push once the K1 button.
3. After the operations described above have been performed, the system starts in Cooling or Heating mode, depending on the external ambient temperature. After a few minutes (from a minimum of 3 to 5 minutes for the internal unit), the system stops automatically, completing the self-test and addressing procedure.
4. "~~8500~~" appears on the display of the outdoor unit. 20 seconds after the display of "~~8500~~" (that confirms the correct execution of the procedure), the following codes (if four internal units are connected) display in sequence on the display of the outdoor unit:

Display1	Display2	Description
00	00	The outdoor unit is communicating correctly with the indoor unit connected to refrigerant pipe A.
01	00	The outdoor unit is communicating correctly with the indoor unit connected to refrigerant pipe B.
02	00	The outdoor unit is communicating correctly with the indoor unit connected to refrigerant pipe C.
03	00	The outdoor unit is communicating correctly with the indoor unit connected to refrigerant pipe D.
04	00	The outdoor unit is communicating correctly with the indoor unit connected to refrigerant pipe E.



At this point it is possible to start the internal units in the desired mode.

※ If "~~8500~~" doesn't display, the procedure has failed and it is therefore necessary to read ALL the operator's manual before repeating the operating described in steps 1-2-3-4.

3. Setting the indoor unit addresses manually

1. Review all the following elements in the installation:
 - Installation site strength
 - Piping connection tightness to detect any gas leakage
 - Connection wiring
 - Heat-resistant insulation of the piping
 - Drainage
 - Earthing wire connection
2. Manually set the indoor unit options by referring to page 30~35.
3. Press the K3 button once or reset the outdoor unit.

NOTE | • The Display 1/2 indications are the same as in the automatic address setting mode.

Setting of Key and Display of the outdoor unit

- Key option of the outdoor unit
 - K1: Function button - K3: Reset button

Push	Key	K1	K3
1		Pipe Checking Operation	Reset
2		Cool Mode Try run	
3		Heat Mode Try run	
4		Pump Down	
5		Finish Key Operation	

※ For more information of the Cool or Heat Try run test, refer to page 4-29.

- K4 View mode Display changes

- PCB MAIN - OUT
(AJ020TXJ2CH, AJ024TXJ3CH)

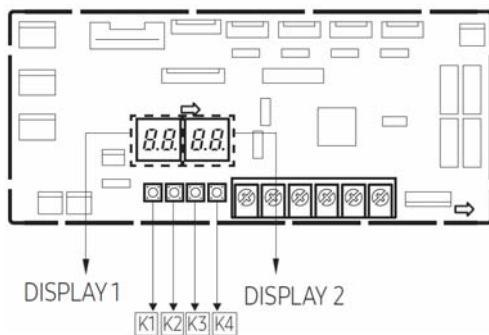

- PCB MAIN - OUT
(AJ020TXS3CH, AJ***TX*4CH, AJ***TX*5CH)



- K4 View mode Display changes

Push	Display Explanation	Push	Display Explanation
1	Present Compressor Frequency	9	Discharge temperature
2	Target Compressor Frequency	10	OLP temperature
3	EEV0 current step	11	Condenser temperature
4	EEV1 current step	12	Outdoor temperature
5	EEV2 current step	13	Running current
6	EEV3 current step	14	Target Discharge temperature
7	EEV4 current step	15	Total capacity of the indoor units
8	Fan RPM (H: high, L: low, Blank: off)	16	Safety Control (just For Service Technician)

4-3 Setting Option

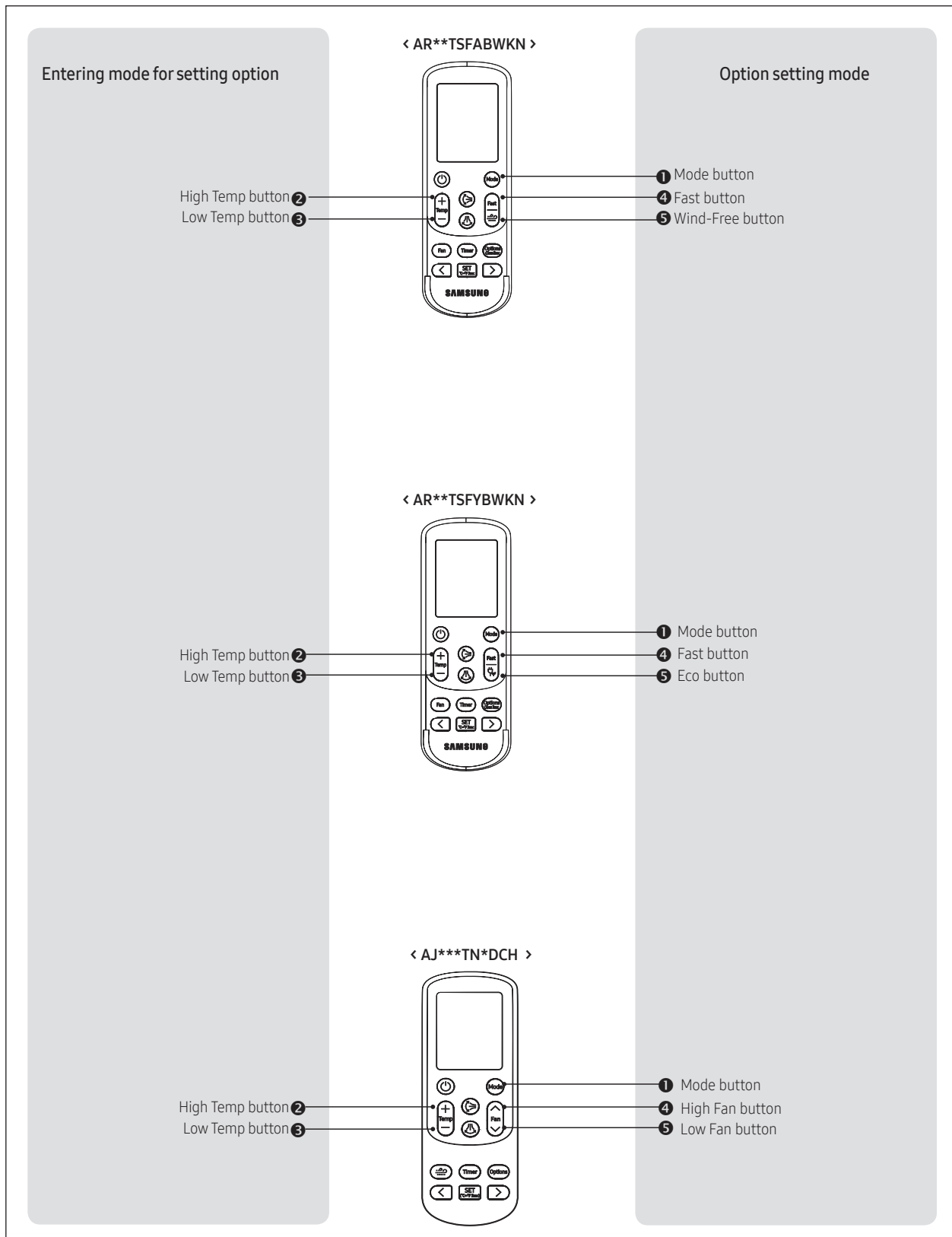

4-3-1 Setting Option

- 1 Remove batteries from the remote controller
- 2 Insert batteries and enter the option setting mode while pressing **2** button and **3** button.
- 3 Each time you press **5** button, 7-seg on left side is increased by "1" and each time you press **4** button, 7-seg on right side is increased by "1"
- 4 You press **1** button to move to the next setting page.
- 5 After setting option, press **1** button to check whether the option code you input is correct or not.

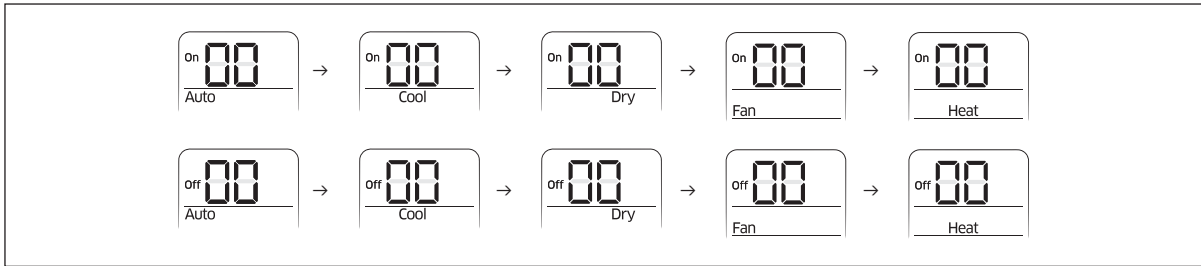





- 6 Press operation button with the direction of remote control for set.

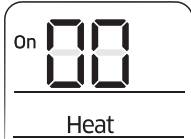
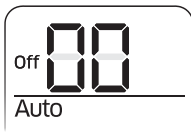
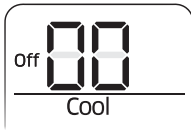
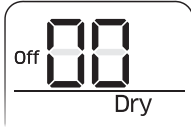

- SEG1, SEG7, SEG13, SEG19 are not set as page option.
- Set the SEG1, SEG7 as ON status and SEG13, SEG19 as OFF status.
 - Set the each option separately since you cannot set the ADDRESS setting and indoor unit installation setting option at the same time.

4-3-2 The procedure of setting option

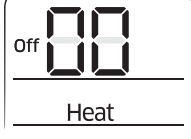
Operation	Indication
Step 1 1 Remove the batteries from the remote controller. 2 Insert batteries while pressing 2 Button and 3 Button.	
Step 2 1 Press 5 button to enter SEG2 value. 2 Press 4 button to enter SEG3 value.	
Step 3 Press 1 button to be change to Cool mode in the ON status. 1 Press 5 button to enter SEG4 value. 2 Press 4 button to enter SEG5 value.	
Step 4 Press 1 button to be changed to DRY mode in the ON status. 1 Press 5 button to enter SEG6. 2 Press 4 button to enter SEG8.	
Step 5 Press 1 button to be changed to FAN mode in the ON status. 1 Press 5 button to enter SEG9 value. 2 Press 4 button to enter SEG10 value.	

Operation	Indication
<p>Step 6 Press 1 button to be changed to HEAT mode in the ON status.</p> <p>1 Press 5 button to enter SEG11 value. 2 Press 4 button to enter SEG12value</p>	
<p>Step 7 Press 1 button to be changed to AUTO mode in the OFF status.</p> <p>1 Press 5 button to enter SEG14 value. 2 Press 4 button to enter SEG15 value.</p>	
<p>Step 8 Press 1 button to be changed to Cool mode in the OFF status.</p> <p>1 Press 5 button to enter SEG16 value. 2 Press 4 button to enter SEG17 value.</p>	
<p>Step 9 Press 1 button to be changed to DRY mode in the OFF status.</p> <p>1 Press 5 button to enter SEG18 value. 2 Press 4 button to enter SEG20 value.</p>	
<p>Step 10 Press 1 button to be changed to FAN mode in OFF status</p> <p>1 Press 5 button to enter SEG21 value. 2 Press 4 button to enter SEG22 value.</p>	
<p>Step 11 Press 1 button to be changed to HEAT mode in the OFF status</p> <p>1 Press 5 button to enter SEG23 value. 2 Press 4 button to enter SEG24 value.</p>	
<p>Step 12</p> <p>Press 1 button to check whether the option code you entered is correct or not. Press operation button  to enter option.</p>	

4-3-3 Setting an indoor unit address (MAIN/RMC)

- 1 Check whether power is supplied or not.
 - When the indoor unit is not plugged in, there should be additional power supply in the indoor unit.
- 2 The panel(display) should be connected to an indoor unit to receive option.
- 3 Before installing the indoor unit, assign an address to the indoor unit according to the air conditioning system plan.
- 4 Assign an indoor unit address by wireless remote controller.
 - The initial setting status of indoor unit ADDRESS(MAIN/RMC) is "0A0000-100000-200000-300000"
 - There is no need to assign extra ADDRESS for 1:1 installation between indoor unit and outdoor unit.

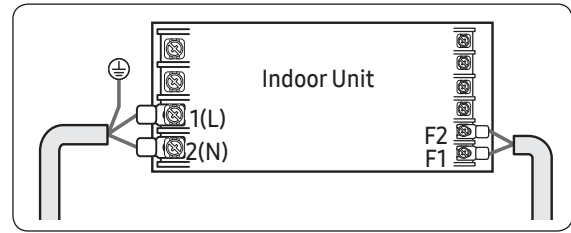

Option No. : 0AXXXX-1XXXXX-2XXXXX-3XXXXX

Option	SEG1		SEG2		SEG3		SEG4		SEG5		SEG6	
Explanation	Page		Mode		Setting main address		100-digit of indoor unit address		10-digit of indoor unit		A single digit of indoor unit	
Indication and details	0	Details	Indication	A	0	No Main address	0~9	100-digit	0~9	10-digit	0~9	A single digit
					1	Main address setting mode						
Option	SEG7		SEG8		SEG9		SEG10		SEG11		SEG12	
Explanation	Page				Setting RMC address				Group channel(*16)		Group address	
Indication and details	1	Details	Indication		0	No RMC address			RMC1	1~F	RMC2	1~F
					1	RMC address setting mode						

※ You must set RMC address setting mode when using the centralized Control.

CAUTION

- When "A"~"F" is entered to SEG4~6, the indoor unit MAIN ADDRESS is not changed.
- If you set the SEG 3 as 0, the indoor unit will maintain the previous MAIN ADDRESS even if you input the option value of SEG4~6.
- If you set the SEG 9 as 0, the indoor unit will maintain previous RMC ADDRESS even if you input the option value of SEG11~12.

- 5 The MAIN address is for communication between the indoor unit and the outdoor unit. Therefore, you must set it to operate the air conditioner properly

4-3-4 Setting an indoor unit installation option (suitable for the condition of each installation location)

■ Wall mounted

- 1 Check whether power is supplied or not.
 - When the indoor unit is not plugged in, there should be additional power supply in the indoor unit.
- 2 The panel(display) should be connected to an indoor unit to receive option.
- 3 Before installing the indoor unit, assign an option to the indoor unit according to the air conditioning system plan.
 - The default setting of an indoor unit installation option is “02000-100000-200000-300000”.
 - Individual control of a remote controller(SEG20) is The function that controls an indoor unit individually when there is more than one indoor unit.
- 4 Set the indoor unit option by wireless remote controller.
 - When entering Address option, connect remote controller receiver.

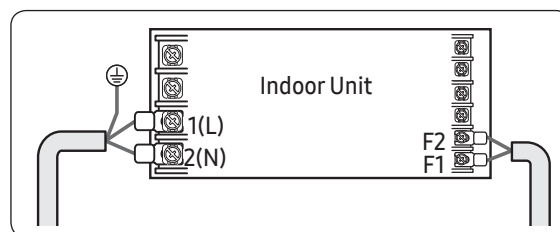

Option	SEG1		SEG2		SEG3		SEG4		SEG5		SEG6	
Explanation	Page		Mode						Central control			
Indication and details	Indication	Details	Indication	Details	Indication	Details	Indication	Details	Indication	Details	Indication	Details
	0		2		0		0		0	No Use	0	
									1	Use		
Option	SEG7		SEG8		SEG9		SEG10		SEG11		SEG12	
Explanation	Page										Master / Slave	
Indication and details	Indication	Details	Indication	Details	Indication	Details	Indication	Details	Indication	Details	Indication	Details
	1		0		0		0		0		0	Slave
											1	Master
Option	SEG13		SEG14		SEG15		SEG16		SEG17		SEG18	
Explanation	Page		External control		External control output				Buzzer			
Indication and details	Indication	Details	Indication	Details	Indication	Details	Indication	Details	Indication	Details	Indication	Details
	2		0	No use	0	Thermo ON	0		0	Use	0	
			1	On/Off control					0	Use		
			2	Off control	1	Operation ON			1	No Use		
3			Window On/Off control ⁽¹⁾									
Option	SEG19		SEG20		SEG21		SEG22		SEG23		SEG24	
Explanation	Page											
Indication and details	Indication	Details	Indication	Details	Indication	Details	Indication	Details	Indication	Details	Indication	Details
	3		0		0		0		0		0	

- ※ If you input a number other than 0~4 of the individual control of the indoor unit(SEG20), the indoor is set as “indoor 1”.
- The window on/off function applies to the following unit
 - AR***

■ Mini 4Way / Home Duct / Console

- The indoor unit installation option are set to 020000-100000-200000-300000 by default.
- Set the indoor unit option by wireless remote controller. When entering Address option, connect remote controller receiver.

Installation options

SEG1	SEG2	SEG3	SEG4	SEG5	SEG6
0	2	Reserved	Use of external temperature sensor	Use of central control	Compensation of the fan RPM
SEG7	SEG8	SEG9	SEG10	SEG11	SEG12
1	Using of drain pump	Reserved	Reserved	Reserved	Remote control
SEG13	SEG14	SEG15	SEG16	SEG17	SEG18
2	Use of external control	Setting the output of external control	S-Plasma ion	Buzzer Control	Hours of filter usage
SEG19	SEG20	SEG21	SEG22	SEG23	SEG24
3	Individual control with remote control	Heating setting compensation offset	The lowest limit of outdoor temperature for heating operation	Motion detection sensor	Reserved

- Even if you set the Use of drain pump (SEG8) option to 0, it is automatically set to 2 (the drain pump is used with 3 minute delay).
- If you set the Maximum filter usage time (SEG18) option to a value other than 2 and 6, it is automatically set to 2 (1000 hours).
- If you set an option to a value that is out of range specified above, the option is automatically set to 0 by default.
- The external output of SEG15 is generated via MIM-B14 connection. (Refer to the manual of MIM-B14.)
- If you set the Individual control with remote control (SEG20) option to a value other than 0 to 4, it is automatically set to 0 (Indoor 1).

Installation option (Detailed)

Option No. : 02XXXX-1XXXX-2XXXX-3XXXX

Option	SEG1		SEG2		SEG3		SEG4		SEG5		SEG6	
Explanation	Page		Mode		Reserved		Use of external temperature sensor		Use of central control		Compensation of the fan RPM	
Indication and Details	Indication	Details	Indication	Details			Indication	Details	Indication	Details	Indication	Details
	0		2				0	Disuse	0	Disuse	0	Disuse (recessed installation)
										1	High ceiling mode	
											2	High ceiling Kit
											3	Noise reduction operation mode
Option	SEG7		SEG8		SEG9		SEG10		SEG11		SEG12	
Explanation	Page		Use of drain pump		Reserved		Reserved		Reserved		Remote control	
Indication and Details	Indication	Details	Indication	Details							Indication	Details
	1		0	Disuse							0	Slave
			1	Use								
			2	Use with 3 minute delay			1	Master				
Option	SEG13		SEG14		SEG15		SEG16		SEG17		SEG18	
Explanation	Page		Use of external control		Setting the output of external control		S-Plasma ion		Buzzer Control		Maximum filter usage time	
Indication and Details	Indication	Details	Indication	Details	Indication	Details	Indication	Details	Indication	Details	Indication	Details
	2		0	Disuse	0	Thermo ON	0	Disuse	0	Use of buzzer	2	1000 hours
			1	ON or OFF control								
			2	OFF control	1	Operation ON	1	Use	1	Disuse of buzzer	6	2000 hours
		3	Window ON or OFF control									

Option	SEG19		SEG20*2)		SEG21		SEG22		SEG23			SEG24
Explanation	Page		Individual control with remote control		Heating setting compensation offset		The lowest limit of outdoor temperature for heating operation		Motion detection sensor			Reserved
Indication and Details	Indication	Details	Indication	Details	Indication	Details	Indication	Details	Indication	Details		
										Standard / Premium	Details	
		3		0 or 1	channel 1	0	Default*1)	0	Disuse	0	Disuse	
			2	channel 2	1	2°C	1			Disuse	1	Standard
	3		channel 3	2							Turn out in 60 min. without motion	
	4		channel 4	2	5°C	1	Use			3	Premium	
								4	Turn out in 240 min. without motion			
									5			Turn out in 30 min. without motion
									6			Turn out in 60 min. without motion
									7		Turn out in 120 min. without motion	
								8	Turn out in 180 min. without motion			

*1) If you input a number other than 0~4 of the individual control of the indoor unit(SEG20), the indoor is set as "channel 1".

*2) SEG23 is reserved in Mini 4Way

4-3-5 Changing the addresses and option individually

When you want to change the value of a specific option, refer to the following table and follow the steps in Common steps for setting the addresses and options on page 18.

Option	SEG1		SEG2		SEG3		SEG4		SEG5		SEG6	
Function	Page		Mode		Type of the option to change		Tens position of the option number		Units position of the option number		New value	
Indication and details	Indication	Details	Indication	Details	Indication	Details	Indication	Details	Indication	Details	Indication	Details
		0		D		Option type	0 to F	Tens position value	0 to 9	Units position value	0 to 9	New value

Example: Changing the Buzzer control (SEG17) option of the installation options to 1 disuse.

Option	SEG1		SEG2		SEG3		SEG4		SEG5		SEG6	
Function	Page		Mode		Type of the option to change		Tens position of the option number		Units position of the option number		New value	
Indication	0		D		2		1		7		1	



- If your indoor units support both cooling and heating, the mixed operation (two or more indoor units operate in different modes simultaneously) is not available when the indoor units are connected to the same outdoor unit. If you set an indoor unit as the master indoor unit by using the remote control, the outdoor unit automatically operate in the current mode of the master indoor unit.

4-3-6 Changing a particular option

Option Code	HOME DUCT		
	AJ009TNLDCH	AJ012TNLDCH	AJ018TNLDCH
SEG 1~6	0101FC	0101FC	0101FC
SEG 7~12	1C546B	1C549B	1C582D
SEG 13~18	271A1D	272326	273538
SEG 19~24	370000	370000	370000
SEG 25~30	020010	020010	020010
SEG 31~36	120000	120000	120000
SEG 37~42	200000	200000	200000
SEG 43~48	300100	300100	300100
SEG 49~54	030000	030000	030000
SEG 55~60	100000	100000	100000
SEG 61~66	200000	200000	200000
SEG 67~72	300000	300000	300000

Option Code	CONSOLE			
	AJ009TNJDCH	AJ012TNJDCH	AJ015TNJDCH	AJ018TNJDCH
SEG 1~6	0191FF	0191FF	0191FF	0191FF
SEG 7~12	1930B7	1930D9	1920FB	19240B
SEG 13~18	271A23	272328	272C38	27343C
SEG 19~24	370560	370660	330400	330400
SEG 25~30	020010	020010	020010	020010
SEG 31~36	100000	100000	100000	100000
SEG 37~42	200000	200000	200000	200000
SEG 43~48	300100	300100	300100	300100
SEG 49~54	030000	030000	030000	030000
SEG 55~60	100000	100000	100000	100000
SEG 61~66	200000	200000	200000	200000
SEG 67~72	300000	300000	300000	300000

Option Code	MINI 4WAY		
	AJ009TNNDCH	AJ012TNNDCH	AJ018TNNDCH
SEG 1~6	0151FF	0151FF	0151FF
SEG 7~12	1910C8	1930F9	19345D
SEG 13~18	271A22	272328	27343C
SEG 19~24	370000	370000	370040
SEG 25~30	020010	020010	020010
SEG 31~36	100001	100001	100001
SEG 37~42	200000	200000	200000
SEG 43~48	300100	300100	300100
SEG 49~54	030000	030000	030000
SEG 55~60	100000	100000	100000
SEG 61~66	200000	200000	200000
SEG 67~72	300000	300000	300000

- If you are going to use up to SEG 24, please refer to following instruction.

SEG18 :

	Not is use	Use
Change temperature display	0 (Celsius)	1 (Fahrenheit)
Sound Mute	0	2

- ※ If you want to use multiple functions, add each of the 'use' value of the function you want to used and input the final addition as option value. (Use Fahrenheit + Sound mute : 1 + 2 = 3)





ex) 044217-1d00e6-200000-300000

When using Sound mute : 044217-1d00e6-200002-300000

When using Fahrenheit and Sound mute : 044217-1d00e6-200003-300000

4-4 Items to be checked first

1. The input voltage should be rating voltage $\pm 10\%$ range.
The air conditioner may not operate properly if the voltage is out of this range.
2. Is the link cable linking the indoor unit and the outdoor unit linked properly?
The indoor unit and the outdoor unit shall be linked by 4 cables.
Check the terminals if the indoor unit and outdoor unit are properly linked by the same number of cables.
Otherwise the air conditioner may not operate properly.
3. When a problem occurs due to the contents illustrated in the table below it is a symptom not related to the malfunction of the air conditioner.

No	Operation of air conditioner	Explanation
1	In a COOL operation mode, the compressor does not operate at a room temperature higher than the setting temperature that the INDOOR FAN should operate. In a HEAT operation mode, the compressor does not operate at a room temperature lower than the setting temperature that indoor fan should operate.	In happens after a delay of 3 minutes when the compressor is reoperated. The same phenomenon occurs when a power is on. As a phenomenon that the compressor is reoperated after a delay of 3 minutes, the indoor fan is adjusted automatically with reference to a temperature of the air blew
2	Fan speed setting is not allowed in AUTO() or DRY() mode.	The speed of the indoor fan is set to LL in DRY mode. Fan speed is 5 steps and is selected automatically in AUTO mode.
3	Compressor stops operation intermittently in DRY() mode.	Compressor operation is controlled automatically in DRY mode depending on the room temperature and humidity.
4	Compressor of the outdoor unit is operating although it is turned off in a HEAT mode.	When the unit is turned off while de-ice is activated, the compressor continues operation for up to 12 minutes (maximum) until the deice is completed.
5	Timer LED() only of the indoor unit lights up and the air conditioner does not operate.	Timer is being activated and the unit is in ready mode. The unit operates normally if the timer operation is cancelled.
6	The compressor and indoor fan stop intermittently in HEAT mode.	The compressor and indoor fan stop intermittently if room temperature exceeds a setting temperature in order to protect the compressor from overheated air in a HEAT mode.
7	Indoor fan and outdoor fan stop operation intermittently in a HEAT mode.	The compressor operates in a reverse cycle to remove exterior ice in a HEAT mode, and indoor fan and outdoor fan do not operate intermittently for within 20% of the total heater operation.
8	The compressor stops intermittently in a COOL mode or DRY mode, and fan speed of the indoor unit decreases.	The compressor stops intermittently or the fan speed of the indoor unit decreases to prevent inside/outside air frozen depending on the inside/outside air temperature.

■ If Error code is displayed on indoor or outdoor LED, check as follows;

- Manual address setting

Contents		
Q1	Turn on the system. But outdoor units PCB displayed E201 or E101 Error code. Check point Remarks	
	Check point	Remarks
Step 1	Check to Number of indoor unit's SW01.	Outdoor PCB SW01
Step 2	Check to power cable to indoor units. Check to communication cable indoor units.	Wire connect

Contents		
Q2	Turn on the system. But outdoor units PCB displayed E203 Error code.	
	Check point	Remarks
Guidance	Outdoor communication error between the outdoor main PCB and sub PCB.	Outdoor PCB SW01
Step 1	Check to sub PCB wire and replace it.	Wire connect

Contents		
Q3	Turn on the indoor units. But indoor unit displayed E121/122/123/154 Error code.	
Error code	Explanation	
E121	Indoor unit room temperature sensor error (open/short)	
E122	Indoor unit heat exchanger in temperature sensor error (open/short)	
E123	Indoor unit heat exchanger out temperature sensor error (open/short)	
E154	Indoor unite fan error	
Guidance	Please, all units turn off and check to indoor unit's PCB and wire connection. E121/122/123 error detected, replace related sensor.	

Contents		
Q4	Turn on the system. But indoor unit displayed E162/163 Error code.	
Error code	Explanation	
E162	Indoor unit EEPROM Error.	
E163	Indoor unit EEPROM Option Error.	
Guidance	Please, all units turn off and follow guidance. E163 : Please reset indoor Option code. E163 : If you don't know about that, replace indoor unit PCB which is related. E162 : Please replace indoor unit PCB which is related.	

Contents		
Q5	Turn on the system. But outdoor unit displayed E221/237/251/320 Error code.	
Error code	Explanation	
E221	Outside temperature sensor error (open/short)	
E237	Indoor unit heat exchanger in temperature sensor error (open/short)	
E251	Condenser temperature sensor error (open/short)	
E251	Compressor Discharge temperature sensor error (open/short)	
E320	Compressor OLP sensor error (open/short)	
Guidance	Please, The System turn off and replace sensor which is related.	

Contents		
Q6	Indoor units address SW setting correct, but outdoor unit's PCB displayed E201 Error Code.	
	Check point	Remarks
Analysis	Indoor unit's sub PCB address SW or sub PCB is connected by mistake.	
Step 1	Check to indoor unit's sub PCB wire connecting condition. (misconnecting or Sub PCB is out of order)	Indoor Sub PCB
Step 2	Address setting mode change to auto address setting.	
Step 3	Following auto address setting steps.	
Guidance	Manual Address setting is Option in FJM PLUS A. But we solved problem like this situation, with auto address setting.	

- Auto address setting

Contents		
Q1	When the pipe checking operation is finished, outdoor sub PCB display E190 Error code.	
	Check point	Remarks
Analysis	Outdoor unit fails to search indoor units or to check indoor address.	The pipe checking operation
Step 1	Whether The gas and liquid pipes are crossed with each other, check to connecting.	Pipe connecting
Step 2	Check to indoor unit's sensor being connected in proper location.	EEV Coil
Step 3	Check to indoor unit's sensor being connected in proper location.	Indoor sensor
Guidance	During the pipe checking operation , system check temperature change of indoor Heat exchanger. In case, indoor sensor defect, EEV coil connector detach, malfunction of EEV, Leakage of Refrigerant, and etc can make this case.	

- Address setting another case

Contents		
Q1	When the system installation is finished, outdoor unit's PCB display E202 Error code.	
	Check point	Remarks
Analysis	This problem is caused by outdoor unit's communication part trouble or indoor units power and communication line trouble.	The pipe checking operation
Step 1	Check to connect outdoor unit and indoor units cable.	Pipe connecting
Step 2	Replace outdoor unit's ass'y control or indoor unit's ass'y control.	EEV Coil
Guidance	Basically, This error caused by communication between Indoor Units and Outdoor Unit. First of all, check the all communication connection and PCB's status.	

- Operation Error

Contents	
Q1	While using cooling or heating, indoor units display E161 Error code.
	Check point
	Remarks
Analysis	This problem is caused by user's fault. User's simultaneously operate 2 more indoor units in the same time cooling and heating mode.
Guidance	FJM is operate by just cooling or heating mode only. (Only, HR system can operate cooling and heating mode simultaneously in the same time) Outdoor unit will be operate by first received signal, another operation signal is not applied system.

Contents	
Q2	While using cooling or heating, System turn off and display E416 Error code.
	Check point
	Remarks
Analysis	E416 is outdoor unit high discharge temperature safety control Error code. After System restart automatically until 3 times, system stop and display this error. System can be operated by remote controller signal and K3(reset) key input.
Step 1	Check outdoor units installation environment. (air flow blocking, the halation of another outdoor air flow)
Step 2	Check refrigerant leakage.
Step 3	Check outdoor EEV operation.

Contents	
Q3	While using cooling or heating, System Turn off and display E458 Error code.
	Check point
	Remarks
Analysis	E458 Error is related with outdoor unit fan Error. Especially, If system have a some problem in fan, in heating mode , it will be happened. And In auto address setting, without pipe checking operation must be happened it.
Step 1	Check to outdoor fan operation.
Step 2	If outdoor fan operation is clear, start to pipe checking operation.
Guidance	When Auto address setting is finished without pipe checking operation, in heating mode, outdoor unit refrigerant distribution control is malfunction. It make our system to confuse it's condition. But, basically this error code is concerned about fan error.

Contents	
Q3	While using cooling mode, outdoor unit turn off and display E401 Error code.
	Check point
	Remarks
Analysis	This is caused by protection mode behavior. This is indoor Evaporator Freezing protection mode.
Step 1	Please, check indoor unit, whether inlet or outlet grill is closed.
Step 2	Please, check indoor unit, whether indoor fan is working.

Contents	
Q5	When system start in cooling mode, System don't operate and display E441 Error code.
	Check point
	Remarks
Analysis	FJM PLUS is able to operate by -10 C But we admit that minimum Cooling temperature is by -5C Please, Remember cooling operation range.

Contents									
Q6	While using heating, outdoor unit turn off and display E404 Error code.								
	<table border="1"> <thead> <tr> <th>Check point</th> <th>Remarks</th> </tr> </thead> <tbody> <tr> <td colspan="2">Heating overload safety mode make this situation. After System restart automatically until 3 times, System display this error code and stop. System can operate by remote controller input signal or K3(reset) key input.</td> </tr> <tr> <td>Step 1</td> <td>Check indoor units air flow.</td> </tr> <tr> <td>Step 2</td> <td>Check outdoor unit air flow and installation (outdoor air flow blocking & over charging)</td> </tr> </tbody> </table>	Check point	Remarks	Heating overload safety mode make this situation. After System restart automatically until 3 times, System display this error code and stop. System can operate by remote controller input signal or K3(reset) key input.		Step 1	Check indoor units air flow.	Step 2	Check outdoor unit air flow and installation (outdoor air flow blocking & over charging)
Check point	Remarks								
Heating overload safety mode make this situation. After System restart automatically until 3 times, System display this error code and stop. System can operate by remote controller input signal or K3(reset) key input.									
Step 1	Check indoor units air flow.								
Step 2	Check outdoor unit air flow and installation (outdoor air flow blocking & over charging)								

Contents					
Q7	When system start in Heating mode, System don't operate and display E440 Error code.				
	<table border="1"> <thead> <tr> <th>Check point</th> <th>Remarks</th> </tr> </thead> <tbody> <tr> <td colspan="2">FJM PLUS is able to operate up to 30°C But we admit that Maximum Heating temperature is up to 24°C Please, Remember Heating operation range.</td> </tr> </tbody> </table>	Check point	Remarks	FJM PLUS is able to operate up to 30°C But we admit that Maximum Heating temperature is up to 24°C Please, Remember Heating operation range.	
Check point	Remarks				
FJM PLUS is able to operate up to 30°C But we admit that Maximum Heating temperature is up to 24°C Please, Remember Heating operation range.					

- Try-run Check Error

Contents					
Q1	While the system is working try-run mode, system turn off and display E128 / 129 / 246 / 261 / 419 / 422 / 554 Error code.				
	<table border="1"> <thead> <tr> <th>Check point</th> <th>Remarks</th> </tr> </thead> <tbody> <tr> <td colspan="2">These Error codes only apply with Try-run mode, in case of system have some defect as result of try-run operation. * Refer to self-detection algorithm (Check Error Code meaning and check it out)</td> </tr> </tbody> </table>	Check point	Remarks	These Error codes only apply with Try-run mode, in case of system have some defect as result of try-run operation. * Refer to self-detection algorithm (Check Error Code meaning and check it out)	
Check point	Remarks				
These Error codes only apply with Try-run mode, in case of system have some defect as result of try-run operation. * Refer to self-detection algorithm (Check Error Code meaning and check it out)					

4-5 Setting to Cool or Heat only mode, checking and Cool/Heat modes operation test

Setting the outdoor option

- Press and hold K2 to enter the option setting. (Only available when the operation is stopped)
 - If you enter the option setting, display will show the following.

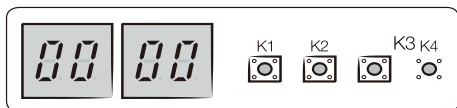

- Seg 1 and Seg 2 will display the number for selected option.
- Seg 3 and Seg 4 will display the number for set value of the selected option.



- Edited option will not be saved if you do not end the option setting as explained in above instruction.
- ※ While you are setting the option, you may press and hold the K1 button to reset the value to previous setting.
- ※ If you want to restore the setting to factory default, press and hold the K4 button while you are in the option setting mode.
 - If you press and hold the K4 button, setting will be restored to factory default but it doesn't mean that restored setting is saved. Press and hold the K2 button. When the segments shows that tracking mode is in progress, setting will be saved.

- If you have selected desired option, you can shortly press the K1 switch to adjust the value of the Seg 1, Seg 2 and change the function for the selected option.

Example)

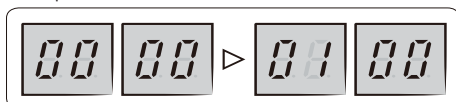

- If you have selected desired option, you can shortly press the K2 switch to adjust the value of the Seg 3, Seg 4 and change the function for the selected option.

Example)

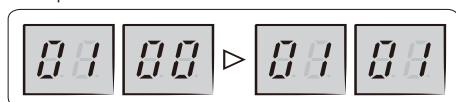

- After selecting the function for options, press and hold the K2 switch for 2 seconds. Edited value of the option will be saved when entire segments blinks and tracking mode begins.

Option item	Input unit	SEG1	SEG2	SEG3	SEG4	Function
Setting to Cool or Heat only mode	Main	0	0	0	0	Cooling and Heating (Factory default)"
				0	1	Only Cooling
				0	2	Only Heating
Power improvement mode	Main	0	1	0	0	Disabled (Factory default)
				0	1	Enabled
Mixed mode indoor input	Main	0	2	0	0	Disabled (Factory default)
				0	1	Enabled
Auto Change Over	Main	0	3	0	0	Disabled (Factory default)
				0	1	Enabled (Factory default)
Channel address	Main	0	4	A	U	Automatic setting (Factory default)
				00 ~ 15		Manual setting

Mode	Temperature
Cool	Approximately 8°C
Heat	Approximately 12°C



- If the outdoor unit is turned off and then immediately turned on again, the compressor does not operate for about 3 minutes.
- During the Cool mode, frost may temporarily develop on valves and other parts.



- You can also test the Cool or Heat Try run using K1 button.

4-6 Fault Diagnosis by Symptom

4-6-1 Indoor

4-6-1-1 Indoor temperature sensor (open/short)

Indoor unit display	X (Operation) ● (Defrost) X (Timer) X (Filter)
	X (Operation) X (Defrost) ● (Reservation) X (Fan) X (Filter)
Symptom	In case of open or short circuit of indoor temperature sensor
Failure	Short or leakage of the corresponding sensor

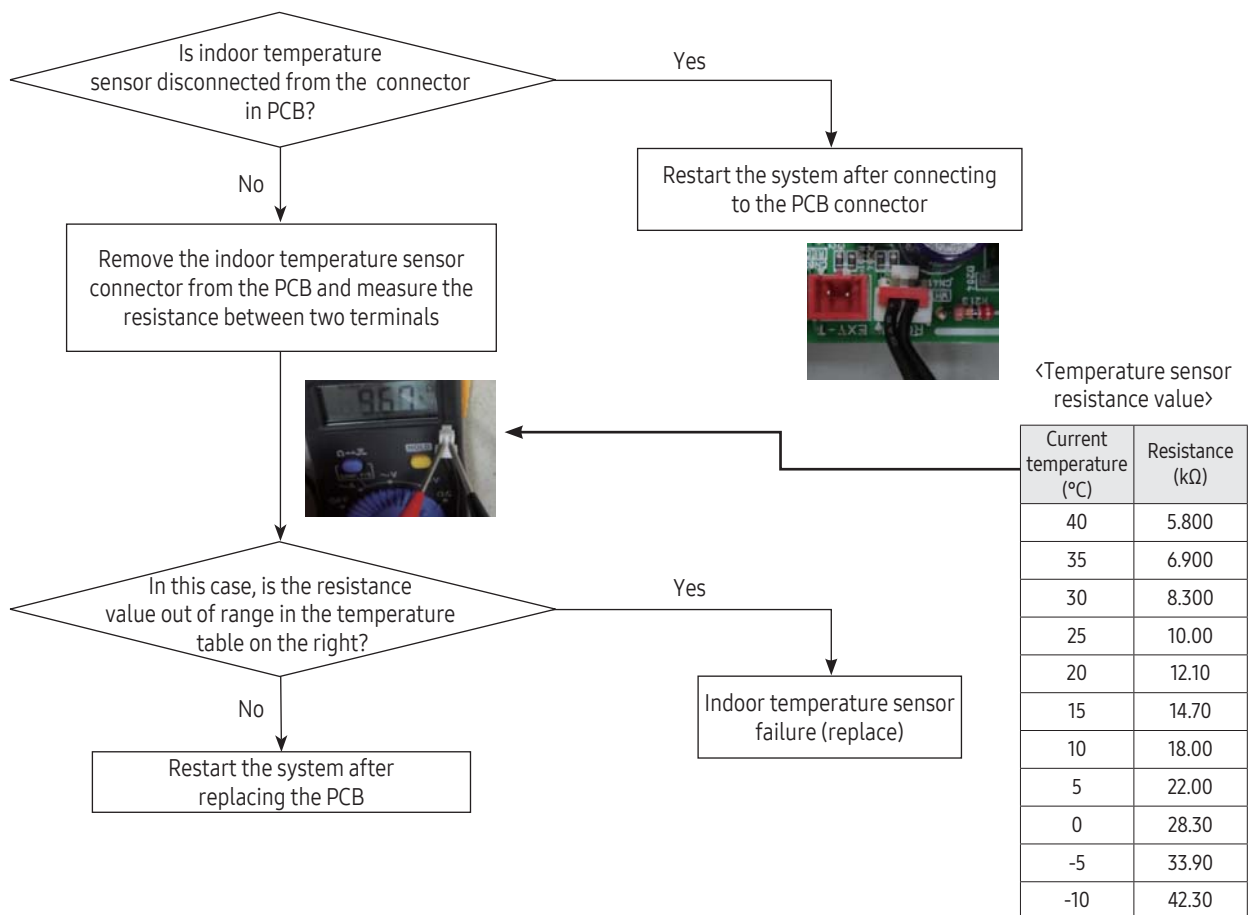

4-6-1-2 Indoor FAN ERROR (BLDC MOTOR MODEL)

Indoor unit display	X (Operation) X (Defrost) ● (Timer) X (Filter)
Symptom	Indoor unit fan dose not run/Runs at excessive high speed and stops.
Failure	Check if the motor connector is disconnected/check the motor fan assembly status.

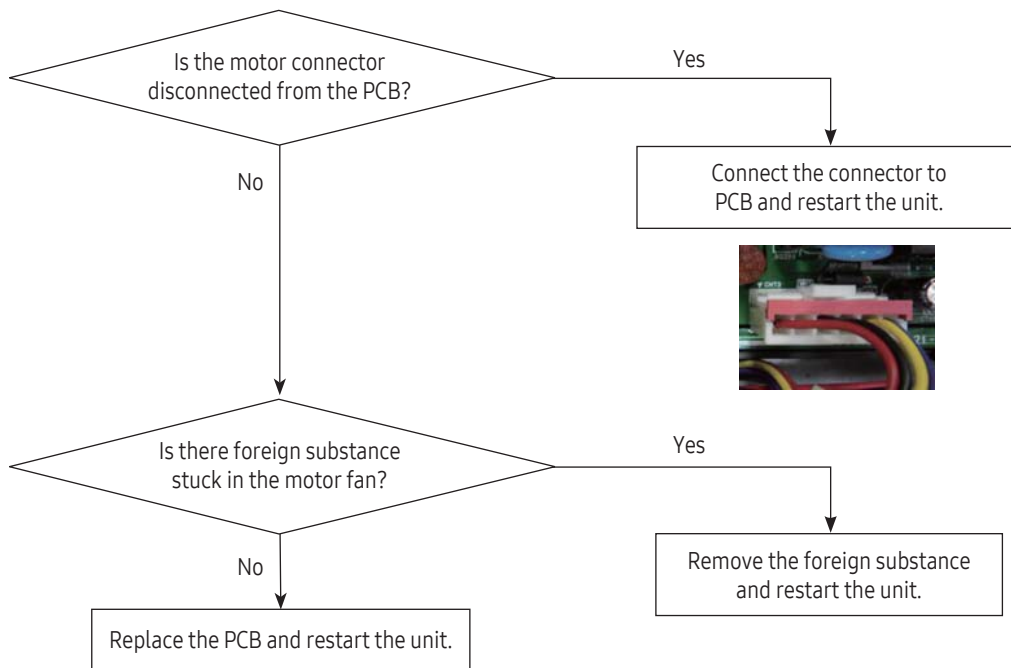

4-6-1-3 Communication error after finishing Tracking

Indoor unit display	X (Operation) ● (Defrost) ● (Timer) X (Filter)
Symptom	Communication error between the indoor and outdoor unit for two minutes
Failure	Communication error between the indoor unit and outdoor unit

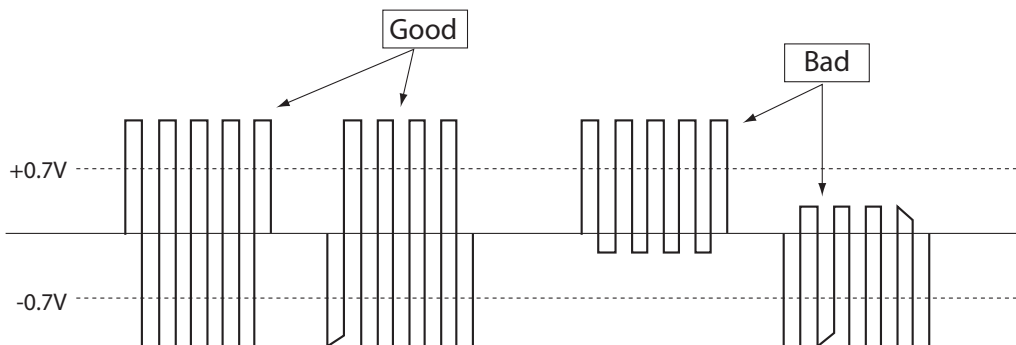
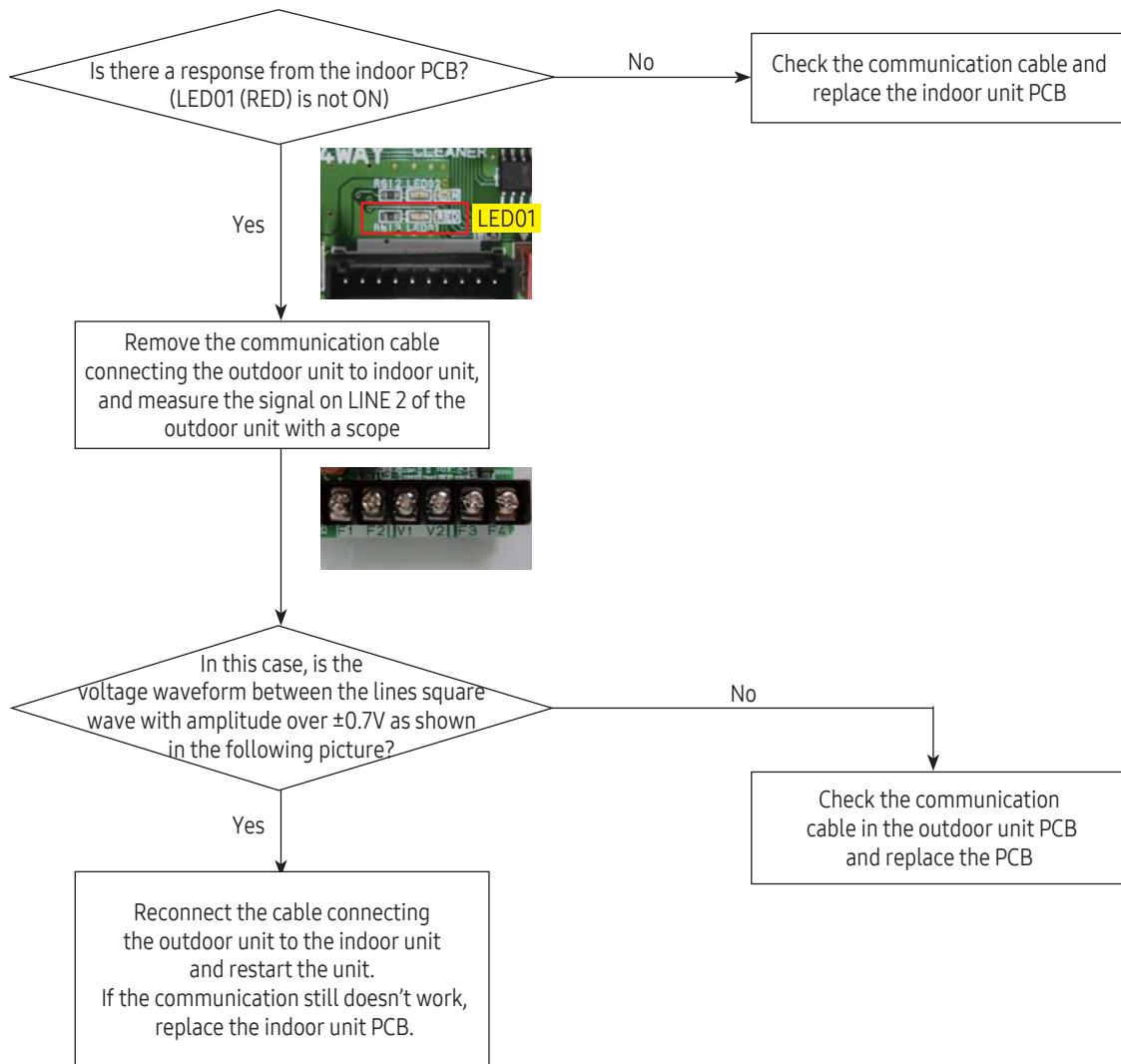

4-6-1-4 Indoor FAN ERROR (BLDC MOTOR MODEL)

Indoor unit display	● (Operation) ● (Defrost) ● (Timer) X (Filter)
Symptom	EEPROM circuit failure.
Failure	EEPROM component failure, EEPROM circuit parts missing/damaged/soldering failure.

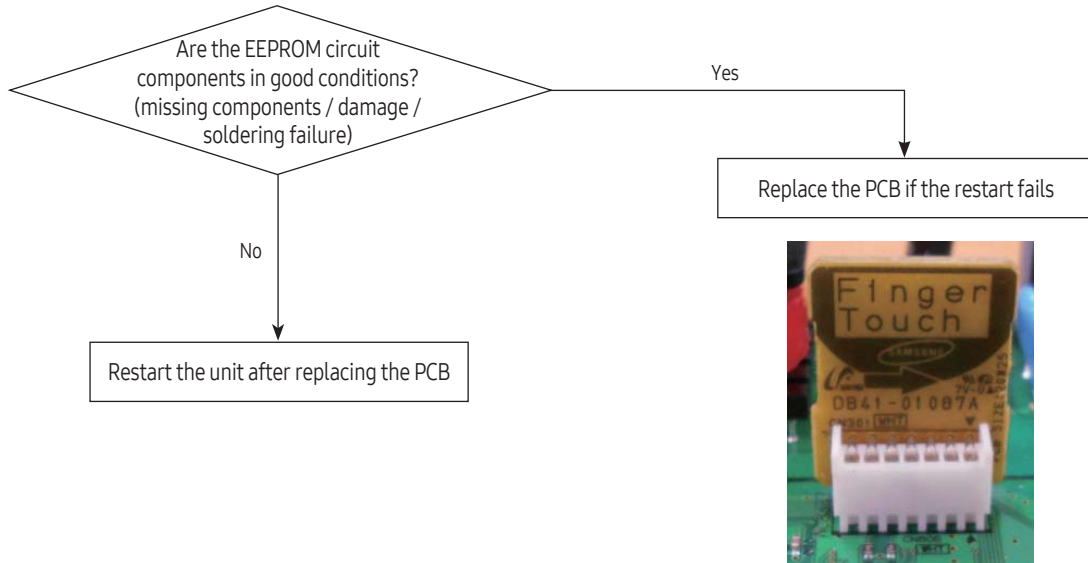

4-6-2 Outdoor unit is not powered on – Initial diagnosis

1. Check items

- 1) Is the power supply voltage 220V?
- 2) Is the AC power connected correctly?
- 3) Are the LEDs in the main PCB and inverter PCB of the outdoor unit ON?
- 4) Is the input power voltage of the indoor unit 220V?
- 5) Is the wired remote controller connected correctly?

2. Check procedure

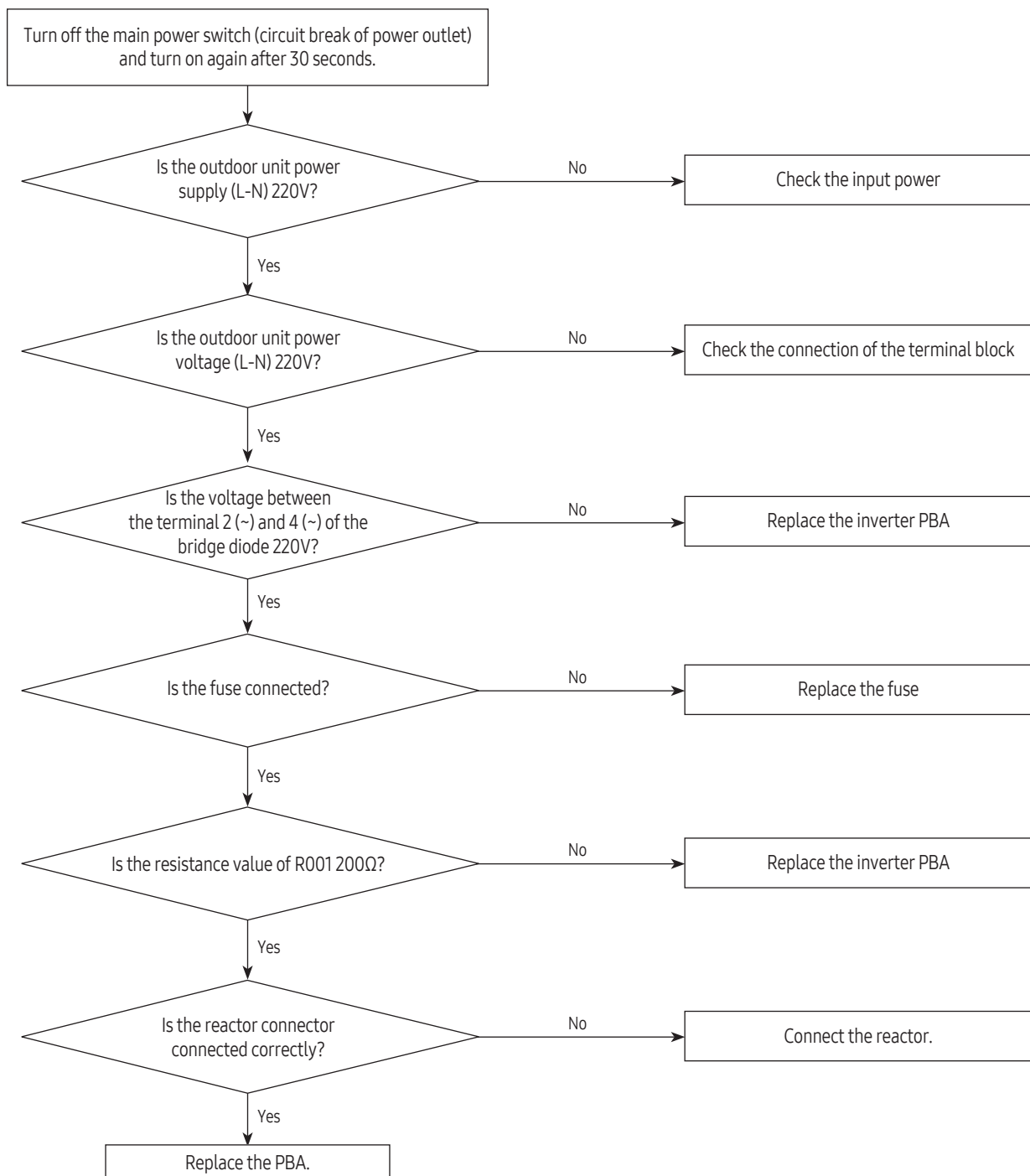

4-6-3 Checking Outdoor Controller

1. Making sure the wire connections.

2. Checking AC(220~240V) line

Caution!

When you remove PBA, you have to check DC link Voltage. After Power off, DC link Voltage is so high!

3. Checking DC voltage on each point

AJ020TXJ2CH, AJ024TXJ3CH (INVERTER PBA)

Item	Measuring point	Normal value
DC LINK	CE151 Voltage	AC220V → 305~310Vdc
Main control 15V	CE161 Voltage	14.5V - 15.5V
Main control 12V	CE175 Voltage	10.8V - 13.2V
Main control 5V	CE174 Voltage	4.75V - 5.25V

AJ020TXS3CH, AJ***TX*4CH, AJ***TX*5CH (MAIN PCB)

Item	Measuring point	Normal value
12V	CE101 Voltage	10.8V - 13.2V
5V	CE105 Voltage	4.75V - 5.25V

AJ020TXS3CH, AJ***TX*4CH, AJ***TX*5CH (INVERTER PCB)

Item	Measuring point	Normal value
DC LINK	CE151 Voltage	AC220V → 305~310Vdc
Main control 15V	CE158 Voltage	14.5V - 15.5V
Main control 12V	CE157 Voltage	10.8V - 13.2V
Main control 5V	CE159 Voltage	4.75V - 5.25V

4. Checking PFCM

Check Resistance between R and S

AJ020TXJ2CH, AJ024TXJ3CH

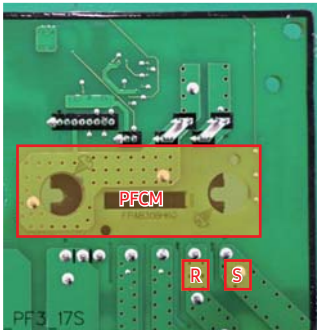

AJ020TXS3CH, AJ***TX*4CH, AJ***TX*5CH (INVERTER PBA)

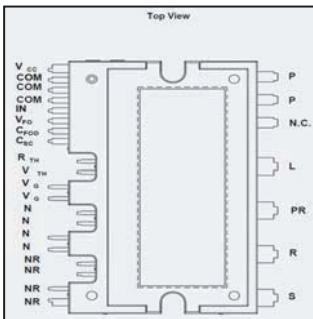
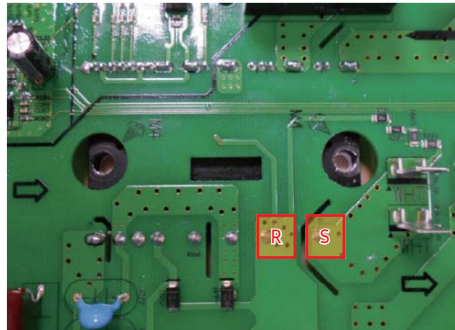

	Measuring point	Normal value
Resistance	R - S	over the hundreds kΩ

4-6-4 Outdoor unit fan error

1. Check items

- 1) Are the input voltage and power connection correct?
- 2) Is the motor connecting wire connected to the outdoor unit PCB correctly?
- 3) Are the indoor/outdoor fuses connected?
- 4) Are there any obstacles near the motor or propeller?
- 5) Is the motor driver out of order?
- 6) RJ040~080 Model check CN901, RJ100 Model Check CN 90.

2. Check procedure

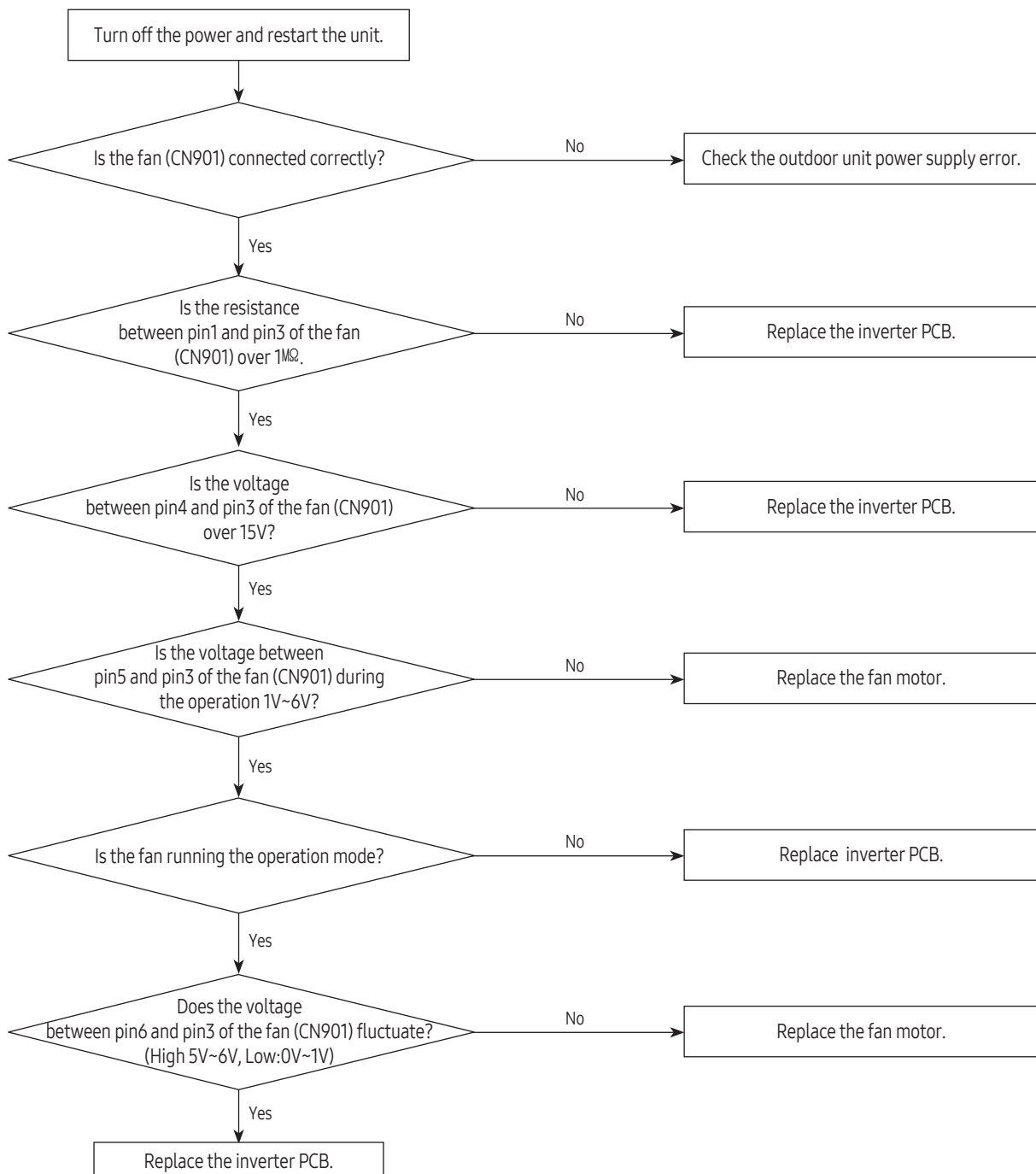

4-6-5 Compressor startup error, Compressor lock error, Compressor rotation error

1. Check items

- 1) Are the power supply and compressor connecting wires connected correctly?
- 2) Is the inter-phase resistance of the compressor normal?

2. Check procedure

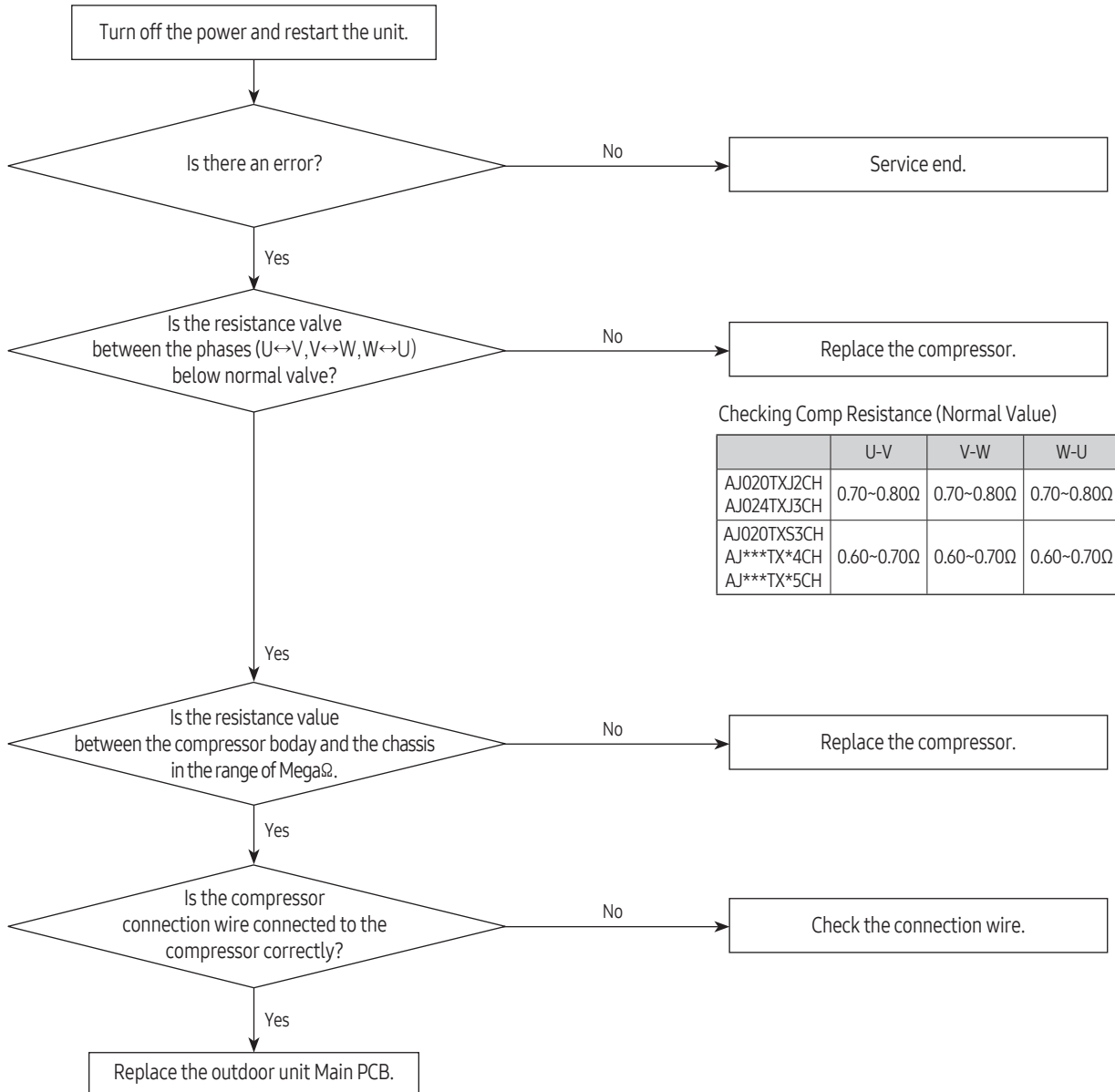

Checking Comp Resistance (Normal Value)

	U-V	V-W	W-U
AJ020TXJ2CH	0.70~0.80Ω	0.70~0.80Ω	0.70~0.80Ω
AJ024TXJ3CH	0.70~0.80Ω	0.70~0.80Ω	0.70~0.80Ω
AJ020TXS3CH	0.60~0.70Ω	0.60~0.70Ω	0.60~0.70Ω
AJ***TX*4CH	0.60~0.70Ω	0.60~0.70Ω	0.60~0.70Ω
AJ***TX*5CH	0.60~0.70Ω	0.60~0.70Ω	0.60~0.70Ω

4-6-6 IPM Over current error

1. Check items

- 1) Is the cool ant changed?
- 2) Is the compressor running normally?
- 3) Is the compressor connected correctly?
- 4) Are there any obstacles near the indoor and outdoor units?

2. Check procedure

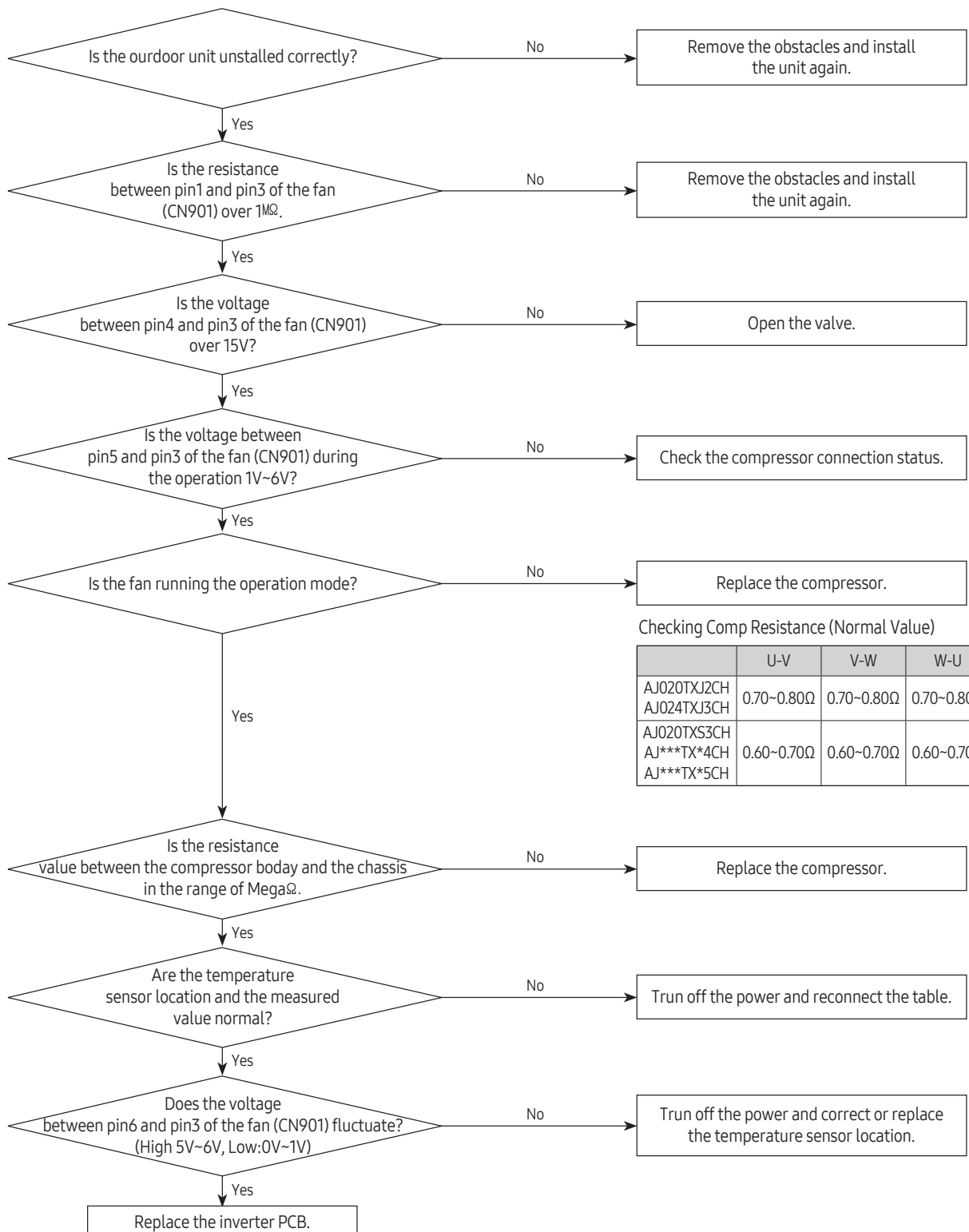

4-6-7 Checking Temperature sensor

4-6-7-1 Checking Temperature sensor

1. Check items

- 1) Is the sensor connected correctly?
- 2) Is the sensor placed correctly?
- 3) Does the both terminal of sensor satisfy the resistance value in accordance with temperature?
- 4) Is the resistance value of sensor connection pull-up correct?

2. Check procedure

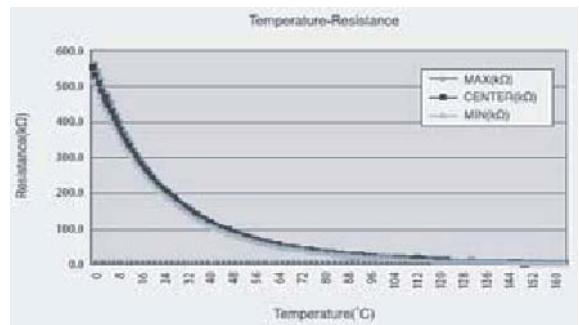
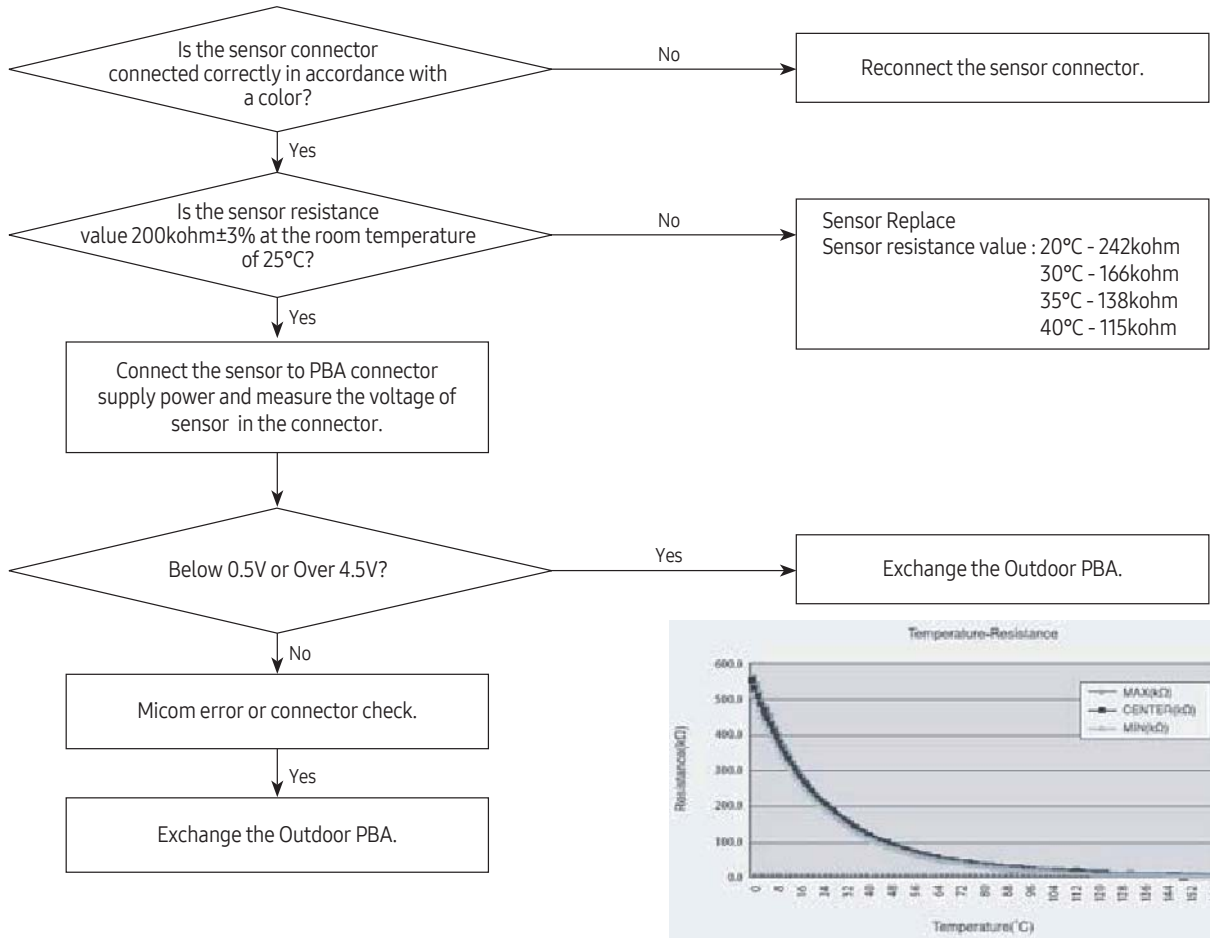

4-6-7-2 Outdoor out/cond temperature sensor error

1. Check items

- 1) Is the sensor connected correctly?
- 2) Is the sensor placed correctly?
- 3) Does the both terminal of sensor satisfy the resistance value in accordance with temperature?
- 4) Is the resistance value of sensor connection pull-up correct?

2. Check procedure

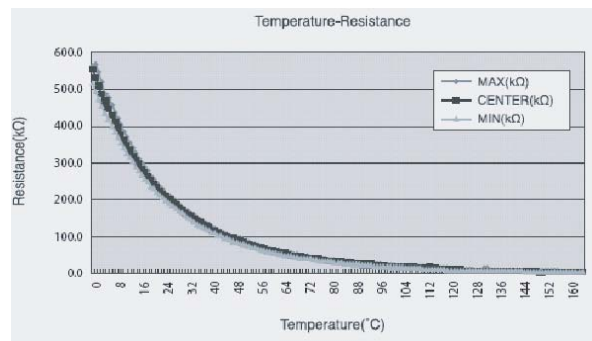
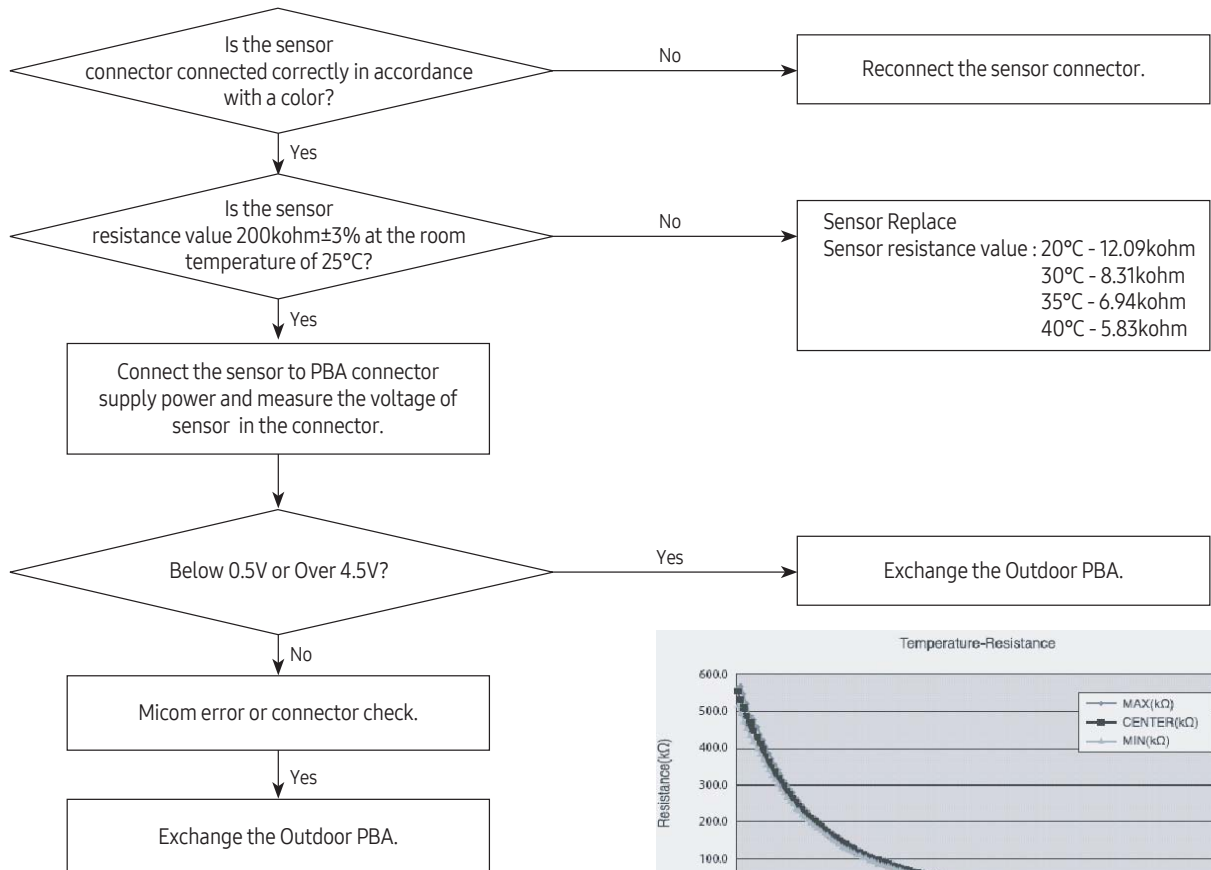

4-7 PCB Inspection

4-7-1 Cautions for Part Replacement

1. The human body carries much static electricity.
Before touching a part for repair, replacement or the similar purpose, be sure to touch a grounded metallic portion by hand to let the static electricity go through the metallic portion to the earth.
Especially when handling any micro computer or IC, carefully remove such static electricity before touching them.
2. When repairing any part on a work bench, be sure to place an insulative sheet on the bench and always keep the sheet surface neat without any metal fragments.
If any such fragment touches a part, a secondary trouble will possibly be caused in the part.
3. Before replacing any parts, be sure to turn off the power supply. If such replacement is done with the power supply kept on, an electric shock, short circuit or destruction of a part may result.
4. During replacement or repair of a part, carefully handle it : The printed circuit board has fine lead wires (jumper wires) and glass-made parts (diode) on its substrate.
So if a circuit board is roughly handled, such lead wires and parts will be easily broken or damaged by bending or shock.
5. When soldering the lead wires of any new part, be sure to polish them using an emery paper or the like before soldering them.
Since the lead wires of any new part are covered with an oxide film, solder cannot adhere to the lead wires if not polished.
6. When soldering any part, care should be exercised not to apply any high-wattage soldering iron to the part for a long time. Some parts are of so low a heat resistance that they may be broken or have the properties changed if a soldering iron is so applied (Otherwise, the pattern may possibly be separated and raised).
7. The heat of the soldering iron should be transferred to the entire object to be soldered. If the solder pieces are not well fused due to insufficient transfer of the heat from the soldering iron, no satisfactory electrical continuity can be assured even if the soldered objects appear well connected to each other.
8. The solder used should be limited to a minimum.
If excessive solder is used, it will cause inter-pattern contact, which may cause malfunction of the circuit.
9. Although some part of the PCB surface are coated with coating material for protection from dust and dirt, soldering is also available to the coating part. Because this coating is thin and is weak for soldering heat. But coating material remaining on the solder part should be cleaned up before soldering a new component to prevent the solder part from becoming bad conduction.
10. After replacing a faulty PCB by a new one, the same address setting must be applied to the new PCB. (refer to the page 4-19 ~ page 4-24)

4-7-2 Procedure

The parts should be replaced in the following procedure.

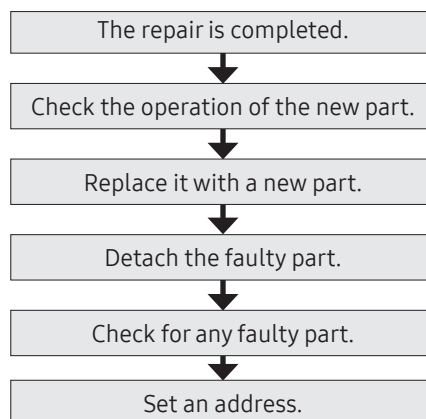

5. PCB Diagram

5-1 Indoor unit

■ Mini 4Way

This Document can not be used without Samsung's authorization.

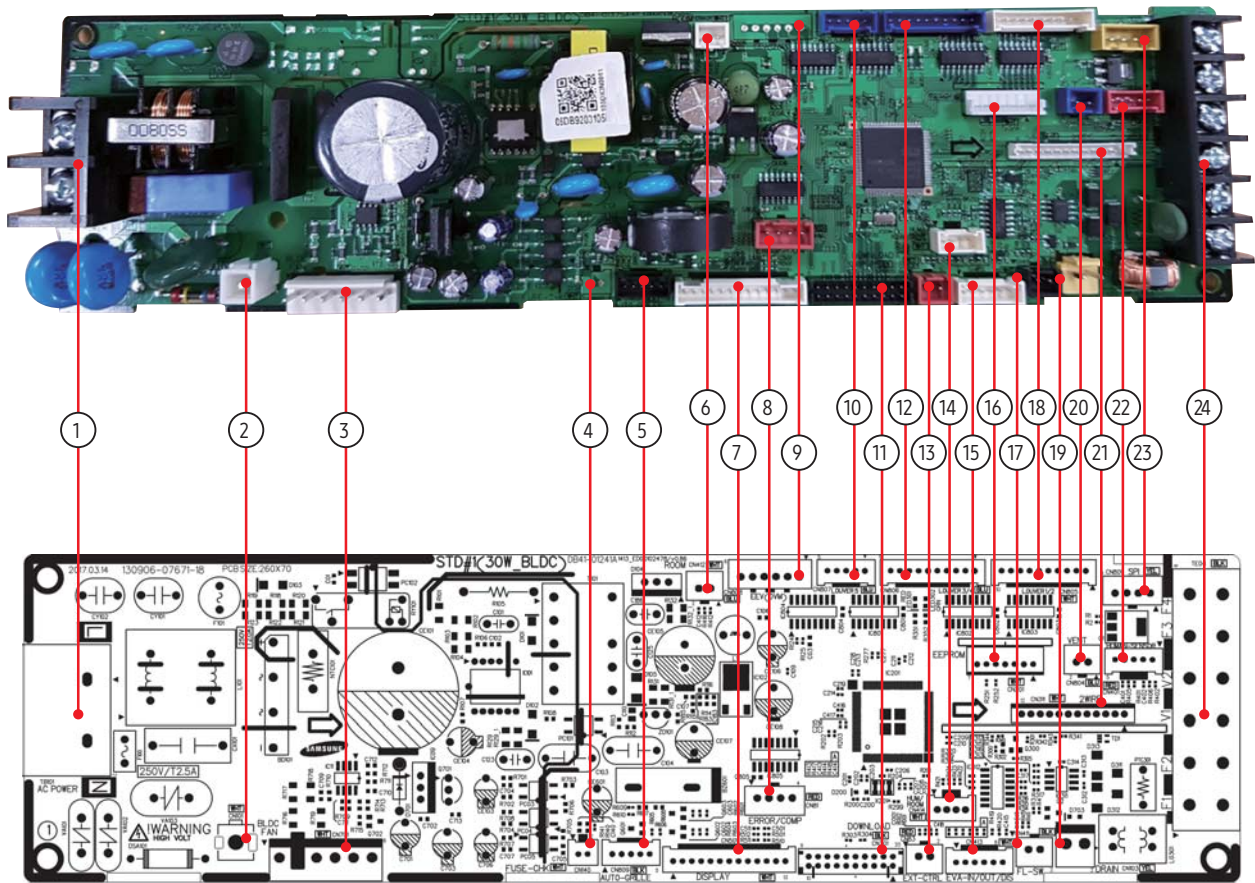

1. TB101-AC POWER	2. CN101-EARTH	3. CN701-BLDC MOTOR	4. CN140-FUSE CHECK	5. CN809-AUTO GRILLE
#1 : AC POWER (L) #2 : AC POWER (N)	#1 : EARTH	#1: DC310V #3 : GND #4 : DC15V #5 : FAN RPM #6 : RPM FEEDBACK	#1 : FUSE CHECK Signal #2 : GND	#1 : DC12V #4 : REMOCON OUT #5 : GND
6. CN412-ROOM SENSOR	7. CN501-DISPLAY		8. CN81-COMP/ERROR MONITOR	9. CN808-EEV
#1 : ROOM SENSOR #2 : GND	#1 : DC12V #2 : LED_0 #3 : LED_1 #4 : LED_2 #5 : LED_3 #6 : LED_4	#7 : LED_5 #8 : REMOCON OUT #9 : AUTO SWITCH #10 : REMOCON IN #11 : GND #12 : DC5V #13 : GND	#1 : DC12V #2 : ERROR OUT (GND) #3 : DC12V #4 : COMP/OPER. OUT (GND)	#1~#4 : EEV SIGNAL #5 : DC12V #6 : DC12V
10. CN807-LOUVERS5	11. CN301-DOWNLOAD	12. CN806-LOUVER3/4	13. CN83-EXT CTRL	14. CN414-HUMIDITY SENSOR
#1 : DC12V #2~#5 : LOUVER SIGNAL		#1 : DC12V #2~#5 : LOUVER SIGNAL #6 : DC12V #7~#10 : LOUVER SIGNAL	#1 : GND #2 : EXTERNAL CONTROL SIGNAL	#1 : DC5V #2 : GND #3 : THERMISTOR SENSOR #4 : HUMIDITY SENSOR
15. CN413:THERMISTOR	16. CN201-EEPROM	17. CN411-FLOAT SWITCH	18. CN805-LOUVER1/2	19. CN103-DRAIN PUMP
#1 : EVA-IN SENSOR #2 : GND #3 : EVA-OUT SENSOR #4 : GND #5 : DISCHARGE SENSOR #6 : GND	#1 : GND #3 : DC5V #4 : EEPROM_SELECT #5 : EEPROM_SO #6 : EEPROM_SI #7 : EEPROM_CLK	#1 : FLOAT SWITCH SIGNAL #2 : GND	#1 : DC12V #2~#5 : LOUVER SIGNAL	#1 : DRAIN PUMP (DC12V) #2 : GND
20. CN804-VENTILATOR	21. CN311-2 WIRED SUB	22. CN401-HUMAN SENSING	23. CN801-SPI	24. TE04-COMMUNICATION
#1 : DC12V #2 : VENT SIGNAL OUTPUT(GND)		#1 : DC12V #2 : MAIN-HUMAN SENSOR COMM(TXD) #3 : MAIN-HUMAN SENSOR COMM(RXD) #4 : GND	#1 : GND #2 : GND #3 : SPI SIGNAL (DC12V)	#1 : COM1(F1) #2 : COM1(F2) #3 : V1(DC12V) #4 : V2(GND) #5 : COM2(F3) #6 : COM2(F4)

■ Mini 4Way (PANEL)

- This Document can not be used without Samsung's authorization.

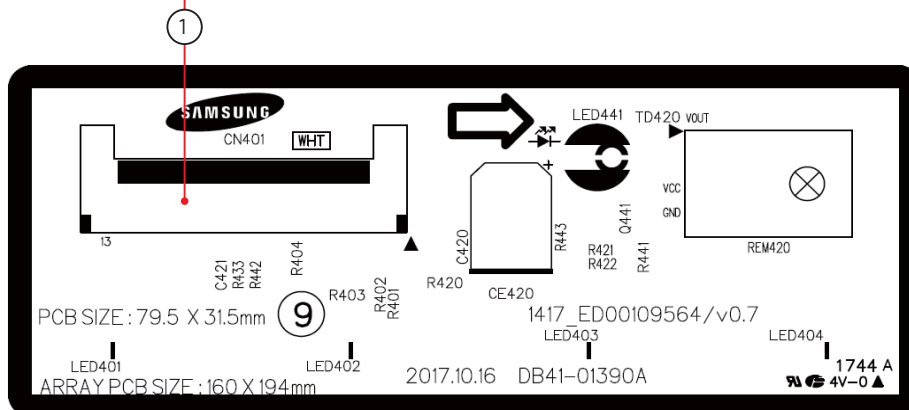
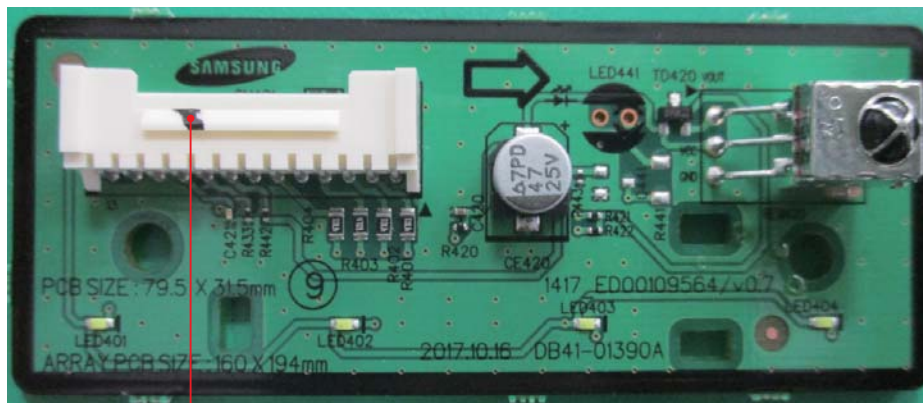

1. CN01-DISPLAY

- #1 : DC12V
- #2 : LED_Operation
- #3 : LED_Defrost
- #4 : LED_Timer
- #5 : -
- #6 : LED_Filter
- #7 : -
- #8 : Remocon Signal Out
- #9 : Panel Select
- #10 : Remocon Signal In
- #11 : GND
- #12 : DC5V
- #13 : -

■ Home Duct

▶ This Document can not be used without Samsung's authorization.

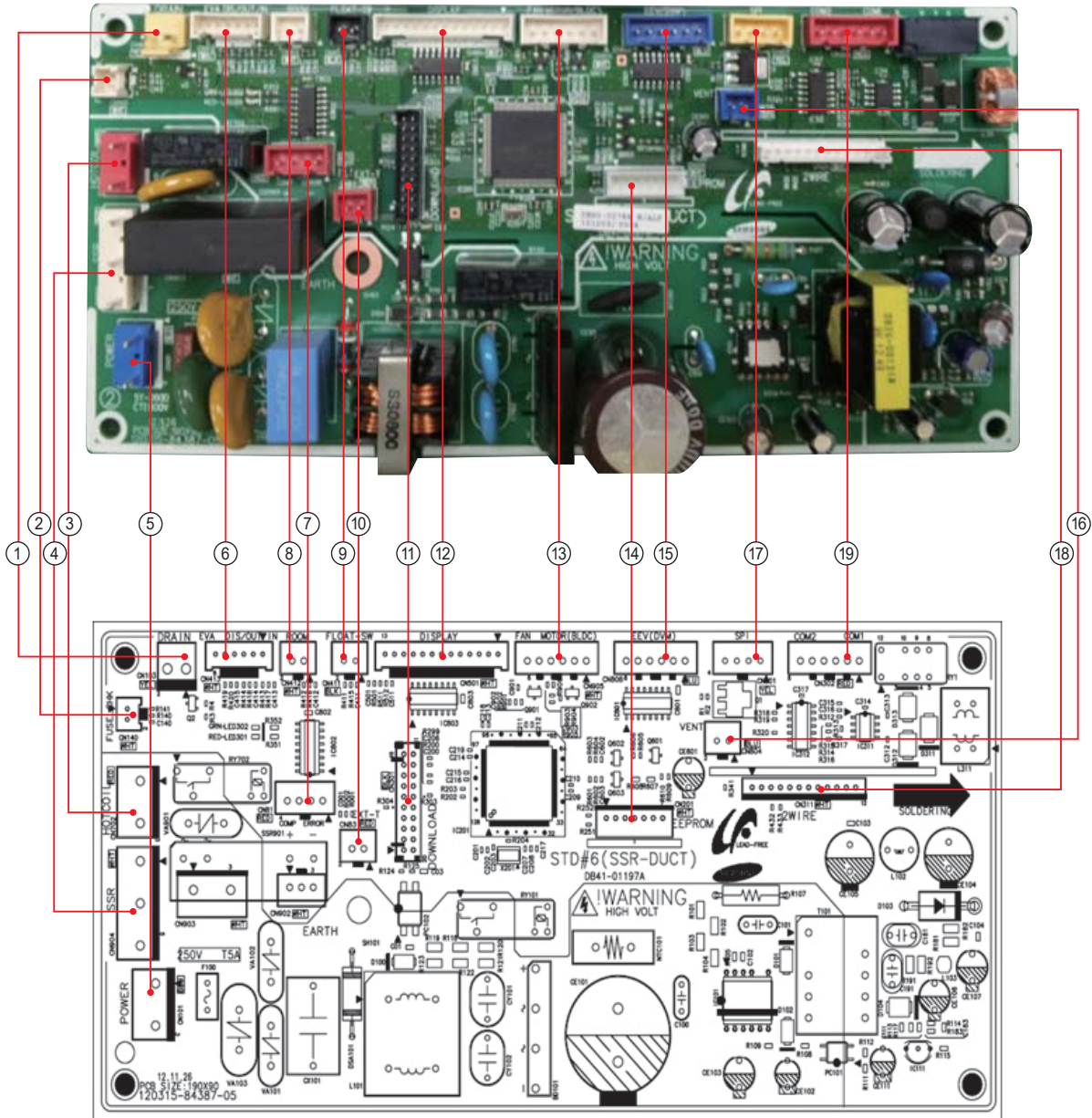

1. CN103-DRAIN	2. CN140-FUSE CHK	3. CN702-HOTCOIL	4. CN904-SSR
#1:POWER #2:GND	#1:POWER #2:GND	#1:N #3:L	#1,#5:N #3:L #2,#4:NO USED
5. CN101-POWER	6. CN413-EVA DIS/OUT/IN	7. CN81-COMP ERROR	8. CN412-ROOM
#1:L #3:N	#1:EVA-IN #3:EVA-OUT #5:DISCHARGE #2,#4,#6:GND	#1,#3:12V #2:ERROR_CHK_OUT #4:COMP_CHK_OUT	#1:ROOM #2:GND
9. CN411-FLOAT SW	10. CN83-EXT T	101. CN301-DOWNLOAD	12. CN501-DISPLAY
#1:FLOAT SW #2:GND	#1:GND #2:EXT_CTRL	For Developer only,Not available in Actual Site - 20 Pin Down Loader	#1:12V #2~#6:DISPLAY LED CONTROL #7:BZ_1 #8:REMOCON SIGNAL OUT #9:AUTO_SW #10:REMOCON_INT #11:GND #12:VCC #13:BZ_2
13. CN905-FAN MOTOR	14. CN201-EEPROM	15. CN808-EEV(DVM)	16. CN804-VENT
#1:12V #2:GND #3:VCC #4:MOTOR SIGNAL PWM1 OUT #5:R903 CONTROL SIGNAL #6:INRUSH OUT	#1:GND #2:NO USED #3:VCC #4:EEPROM_SELECT #5:EEPROM_SO #6:EEPROM_SI #7:EEPROM_CLK	#1~4:CONTROL SIGNAL #5~6:12V	#1:12V #2:VENT_OUT
17. CN801-SPI	18. CN311-2WIRE	19. CN302-COM1 COM2	
#1:GND #2:GND #3:CONTROL SIGNAL #4:NOT USED	#1:12V #2:COM2_PCTRL_MICOM #3:COM2_VCHECK_A #4:COM2_VCHECK_B #5:COM2_MICOM_AD #6:VCC #7:COM2_ENABLE #8:COM2_C #9:COM2_D #10:COM2_Tx #11:COM2_Rx #12:GND	#1~2:COM1 #3:12V #4:GND #5~6:COM2	

■ Console

► This Document can not be used without Samsung's authorization.

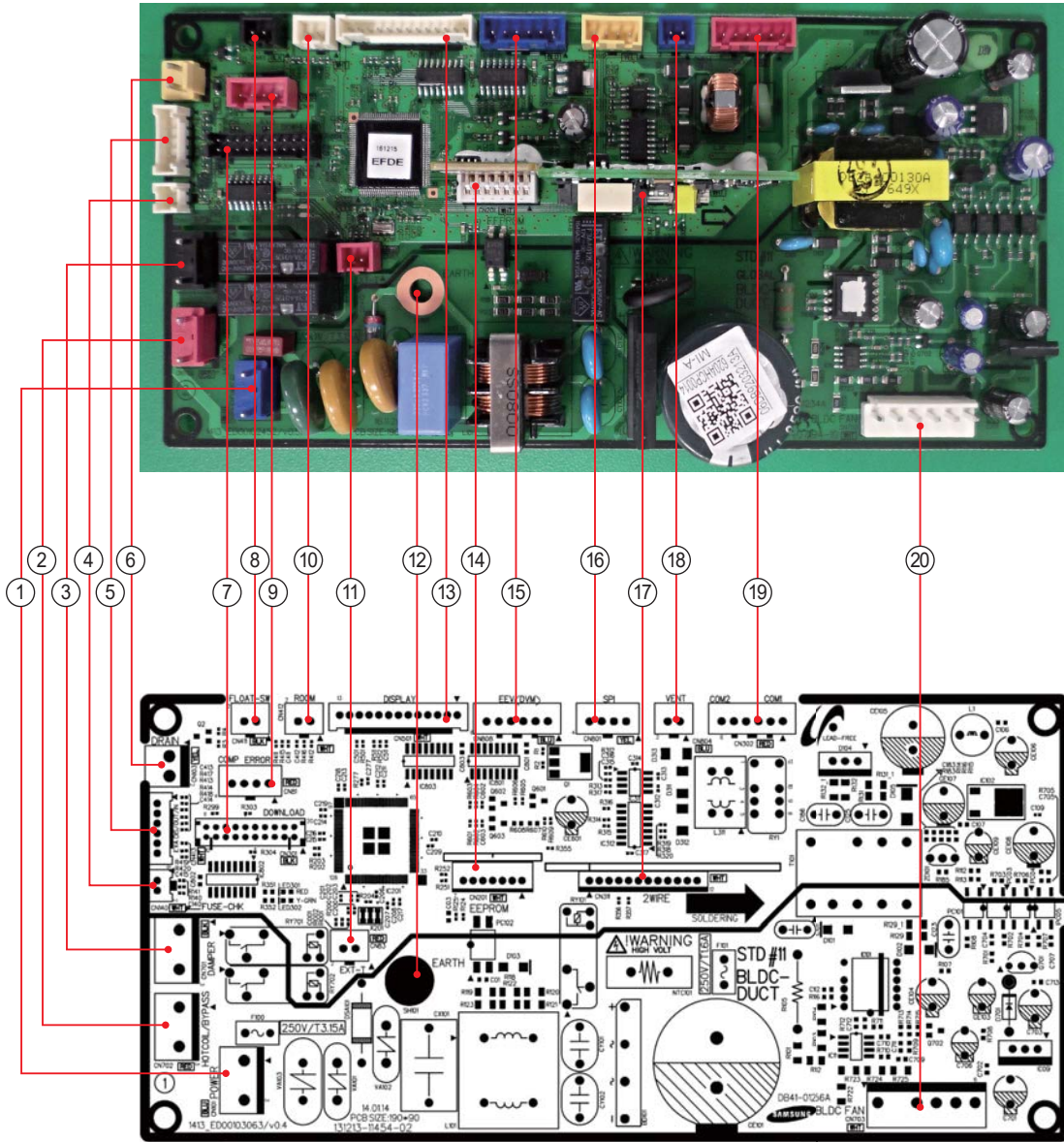

1. CN100-AC POWER	2. CN702-HOT COIL or BYPASS	3. CN703-DAMPER	4. CN140-THERMAL FUSE
#1 : L #3 : N	#1 : N #3 : HOT COIL or BYPASS CONTROL SIGNAL	#1 : N #3 : DAMPER CONTROL SIGNAL	#1 : THERMAL FUSE SIGNAL #2 : GND
5. CN413-EVA IN/OUT/DIS TEMP. SENSOR	6. CN103-DRAIN PUMP	7. CN301-DOWNLOAD	8. CN411-FLOAT SWITCH
#1 : EVI IN TEMP. SENSOR #3 : EVI OUT TEMP. SENSOR #5 : DISCHARGE TEMP. SENSOR #2,4,6 : GND	#1 : DRAIN PUMP CONTROL SIGNAL #2 : GND	#1~8 : DOWNLOAD SIGNAL #9 : GND #10~11 : DC 5V #12~16 : DOWNLOAD SIGNAL #17 : GND #18~20 : DOWNLOAD SIGNAL	#1 : FLOAT SWITCH SIGNAL #2 : GND
9. CN81-ERROR/COMP CHECK	10. CN412-ROOM TEMP. SENSOR	11. CN83-EXTERNAL CONTROL	12. SH101-EARTH
#1 : DC 12V #2 : ERROR CHECK SIGNAL #3 : DC 12V #4 : COMP CHECK SIGNAL	#1 : ROOM TEMP. SENSOR #2 : GND	#1 : GND #2 : EXTERNAL CONTROL SIGNAL	#1 : EARTH
13. CN501-DISPLAY	14. CN201-EEPROM	15. CN808-EEV(DVM)	16. CN801-SPI
#1 : DC 12V #3~10,13 : PANEL SIGNAL #11 : GND #12 : DC 5V	#1 : GND #2 : NOT USED #3 : DC 5V #4~7 : EEPROM SIGNAL	#1~4 : EEV CONTROL SIGNAL #5~6 : DC 12V	#1~2 : GND #3 : SPI CONTROL SIGNAL #4 : NOT USED
17. CN311-2WIRE SUB	18. CN804-VENTILATOR	19. CN302-COMMUNICATION	20. CN703-BLDC MOTOR
#1 : DC 12V #2~5 : COMMUNICATION SIGNAL #6 : DC 5V #7~12 : COMMUNICATION SIGNAL	#1 : DC 12V #2 : VENTILATOR CONTROL SIGNAL	#1~2 : COM1 COMMUNICATION SIGNAL #3 : DC 12V #4 : GND #4~6 : COM2 COMMUNICATION SIGNAL	#1 : DC 310V #3~6 : FAN MOTOR CONTROL SIGNAL

5-2 Outdoor PCB Diagram

■ AJ020TXJ2CH, AJ024TXJ3CH (INVERTER PBA)

▶ This Document can not be used without Samsung's authorization.

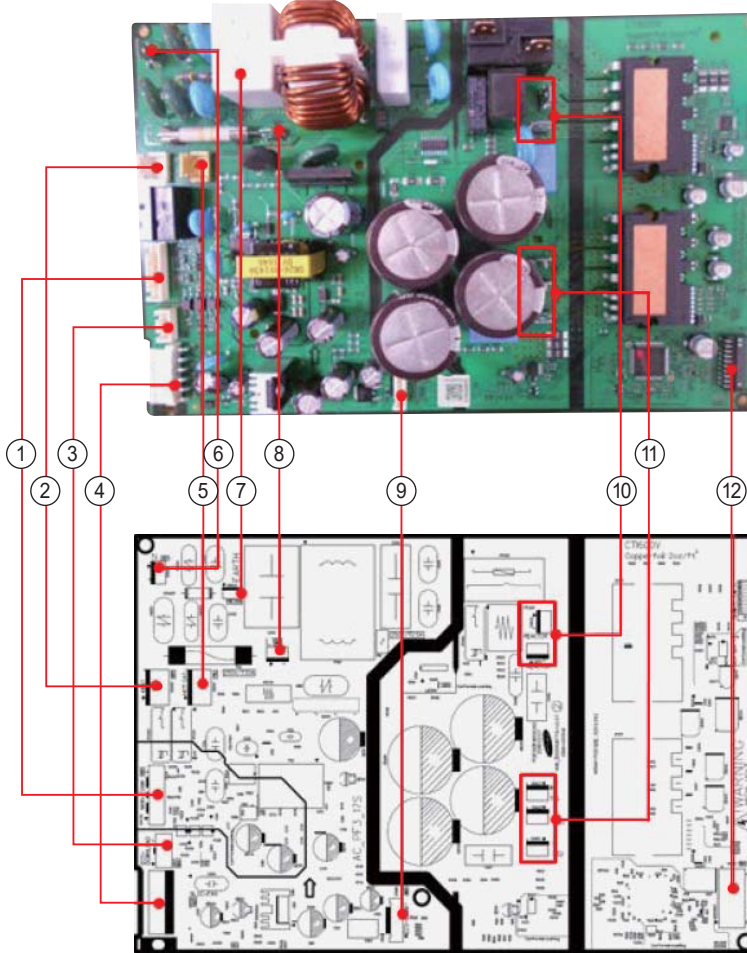

1. CNP351-MAIN INV #1 : RXD #2 : TXD #3 : DC5V #4 : GND #5 : DC12V #6 : POWER CTRL #7 : AC LOAD #8 : AC LOAD2	2. CN030-MAIN POWER #1 : N #2 : - #3 : L	3. CN571-ECO DOWNLOAD #1 ~ 4 : ECO DOWNLOAD	4. CNP901-BLDC FAN #1 : DC310V #2 : - #3 : PGND #4 : DC15V #5 : V_SP #6 : F/B
5. CN241-HOT GAS(AC LOAD) #1 : L/RELAY CONTACT #2 : - #3 : N	6. CN001-N/TAP TERMINAL #1 : N	7. CN571- EARTH TAP TERMINAL #1 : EARTH	8. CN002-L/TAP TERMINAL #1 :L
9. CN581-ECO COMM #1~7 : ECO COMM port	10. CN401, 402, 403-COMP #CN401 : U, RED #CN402 : V, BLU #CN403 : W, YEL	11. CN051, 052-REACTOR #CN501, 052 : REACTOR	12. CN551-DOWNLOAD #1~20 : DOWNLOAD

■ AJ020TXJ2CH, AJ024TXJ3CH (MAIN PBA)

► This Document can not be used without Samsung's authorization.

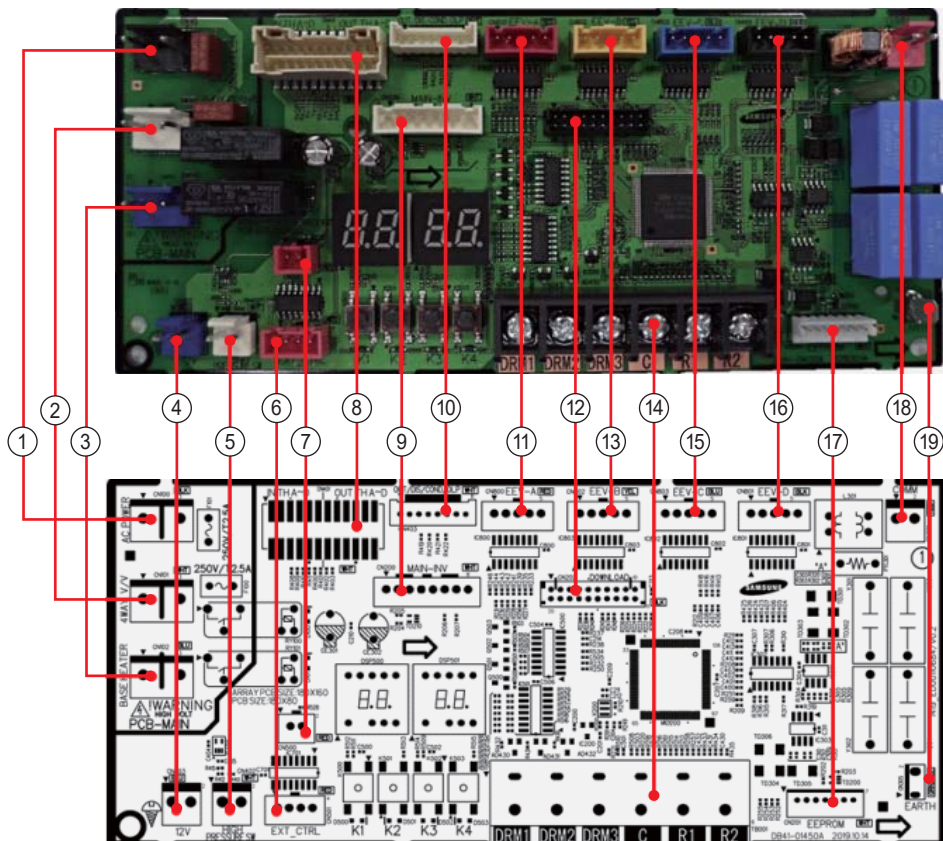

E1. CN100-AC LOAD POWER	2. CN101-4WAY VALVE	3. CN102-BASE HEATER	4. CN303-12V
#1 : L-LIVE POWER INPUT #2 : - #3 : N-NEUTRAL POWER IN PUT	#1 : N-NEUTRAL POWER OUTPUT #2 : - #3 : L-RELAY CONTACT OUTPUT	#1 : N-NEUTRAL POWER OUTPUT #2 : - #3 : L-RELAY CONTACT OUTPUT	#1 : DC 12V #2 : GND
5. CN402-HIGH PRESSURE SWITCH	6. CN501-ERROR CHECK/COMP CHECK	7. CN500- EXTERNAL CONTROL	8. CN401-PIPE IN/OUT TEMPERATURE SENSOR
#1 : HIGH PRESSURE SWITCH INPUT SIGNAL #2 : GND	#1 : DC 12V #2 : ERROR CHECK OUTPUT SIGNAL #3 : DC 12V #4 : COMP CHECK OUTPUT SIGNAL	#1 : GND #2 : EXTERNAL CONTROL INPUT SIGNAL	#1 : PIPE IN-A TEMPERATURE SENSOR #3 : PIPE IN-B TEMPERATURE SENSOR #5 : PIPE IN-C TEMPERATURE SENSOR #7 : PIPE IN-D TEMPERATURE SENSOR #13 : PIPE OUT-A TEMPERATURE SENSOR #15 : PIPE OUT-B TEMPERATURE SENSOR #17 : PIPE OUT-C TEMPERATURE SENSOR #19 : PIPE OUT-D TEMPERATURE SENSOR #2,4,6,8,10,12 : GND #14,16,18,20,22,24 : GND #9,11,21,23 : -
9. CN200 - MAIN ↔ INV COMMUNICATION	10. CN403 - TEMPERATURE SENSOR	11. CN800 - EEV A	
#1 : TCD #2 : RXD #3 : DC 5V #4 : GND #5 : DC 12V #6 : INV POWER CTRL #7 : MAIN AC LOAD POWER CTRL #8 : -	#1 : OUTDOOR TEMPERATURE SENSOR #3 : DISCHARGE TEMPERATURE SENSOR #5 : CONDENSOR TEMPERATURE SENSOR #7 : OLP TEMPERATURE SENSOR #2,4,6,8 : GND	#1 : EEV A SIGNAL #2 : EEV A SIGNAL #3 : EEV A SIGNAL #4 : EEV A SIGNAL #5 : GND	
12. CN202 - DOWNLOAD	13. CN820 - EEV B	14. TB001	15. CN803 - EEV C
#1~20 : DOWNLOAD SIGNAL	#1 : EEV B SIGNAL #2 : EEV B SIGNAL #3 : EEV B SIGNAL #4 : EEV B SIGNAL #5 : GND	#1 : DRED SIGNAL(DRM1) #2 : DRED SIGNAL(DRM2) #3 : DRED SIGNAL(DRM3) #4 : GND #5 : R1 #6 : R2	#1 : EEV C SIGNAL #2 : EEV C SIGNAL #3 : EEV C SIGNAL #4 : EEV C SIGNAL #5 : GND
16. CN801 - EEV D	17. CN201 - EEPROM	18. CN301 - ODU ↔ IDU COMMUNICATION	19. CN305 - COMMUNICATION EMI EARTH
#1 : EEV D SIGNAL #2 : EEV D SIGNAL #3 : EEV D SIGNAL #4 : EEV D SIGNAL #5 : GND	#1 : GND #2 : - #3 : 5V #4 : EEPROM SIGNAL #5 : EEPROM SIGNAL #6 : EEPROM SIGNAL #7 : EEPROM SIGNAL	#1 : F1 #2 : F2	#1 : EARTH

■ AJ020TXS3CH, AJ***TX*4CH, AJ***TX*5CH (INVERTER PBA)

► This Document can not be used without Samsung's authorization.

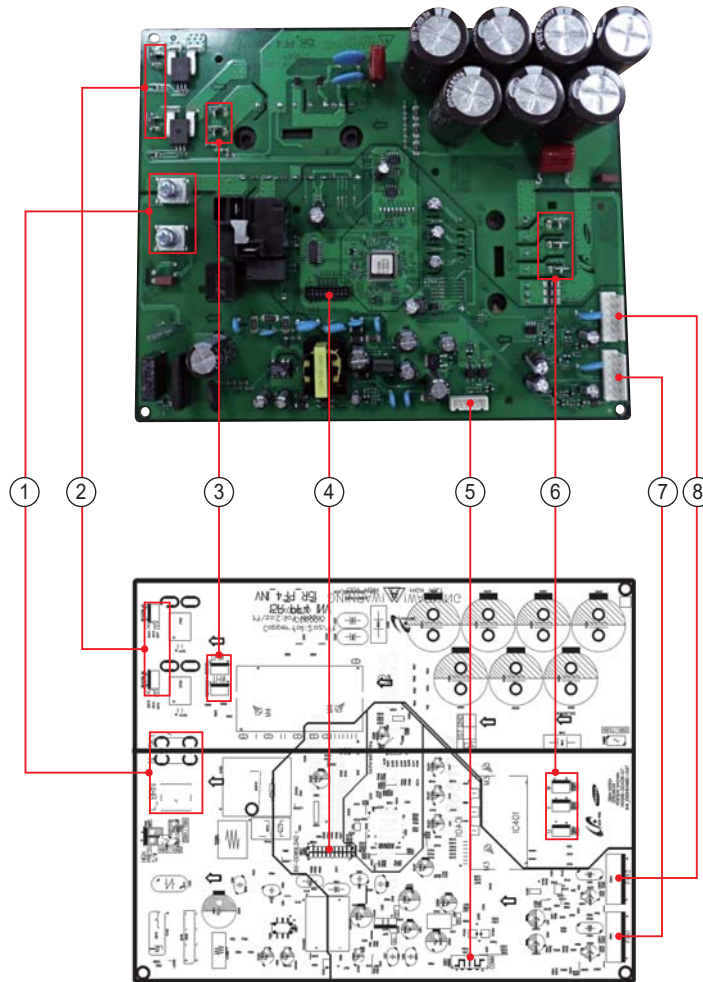

1. L, N - AC POWER INPUT	2. REACTOR-A1/B1	3. REACTOR-A2/B2	4. CN551 - DOWNLOAD
#1 : L - LIVE POWER INPUT / BRN #2 : N - NEUTRAL POWER INPUT / SKY	#REACTOR-A1 : WHT #REACTOR-B1 : WHT	#REACTOR-A2 : BLK #REACTOR-B2 : BLK	#1~20 : DOWNLOAD SIGNAL
5. CN351 - MAIN ↔ INV COMMUNICATION	6. CN401,402,403 – COMPRESSOR	7. CN901 - FAN MOTOR 1	8. CN911 - FAN MOTOR 2
#1 : RXD #2 : TXD #3 : GND #4 : DC 5V #5 : DC 12V #6 : INV POWER CTRL	#CN401 : COMP. U-phase(RED) #CN402 : COMP. V-phase(BLU) #CN403 : COMP. W-phase(YEL)	#1 : DC310V #2 : N.C #3 : GND #4 : DC 15V #5 : FAN RPM #6 : FAN RPM FEEDBACK	#1 : DC310V #2 : N.C #3 : GND #4 : DC 15V #5 : FAN RPM #6 : FAN RPM FEEDBACK

■ AJ020TXS3CH, AJ***TX*4CH, AJ***TX*5CH (MAIN PBA)

▶ This Document can not be used without Samsung's authorization.

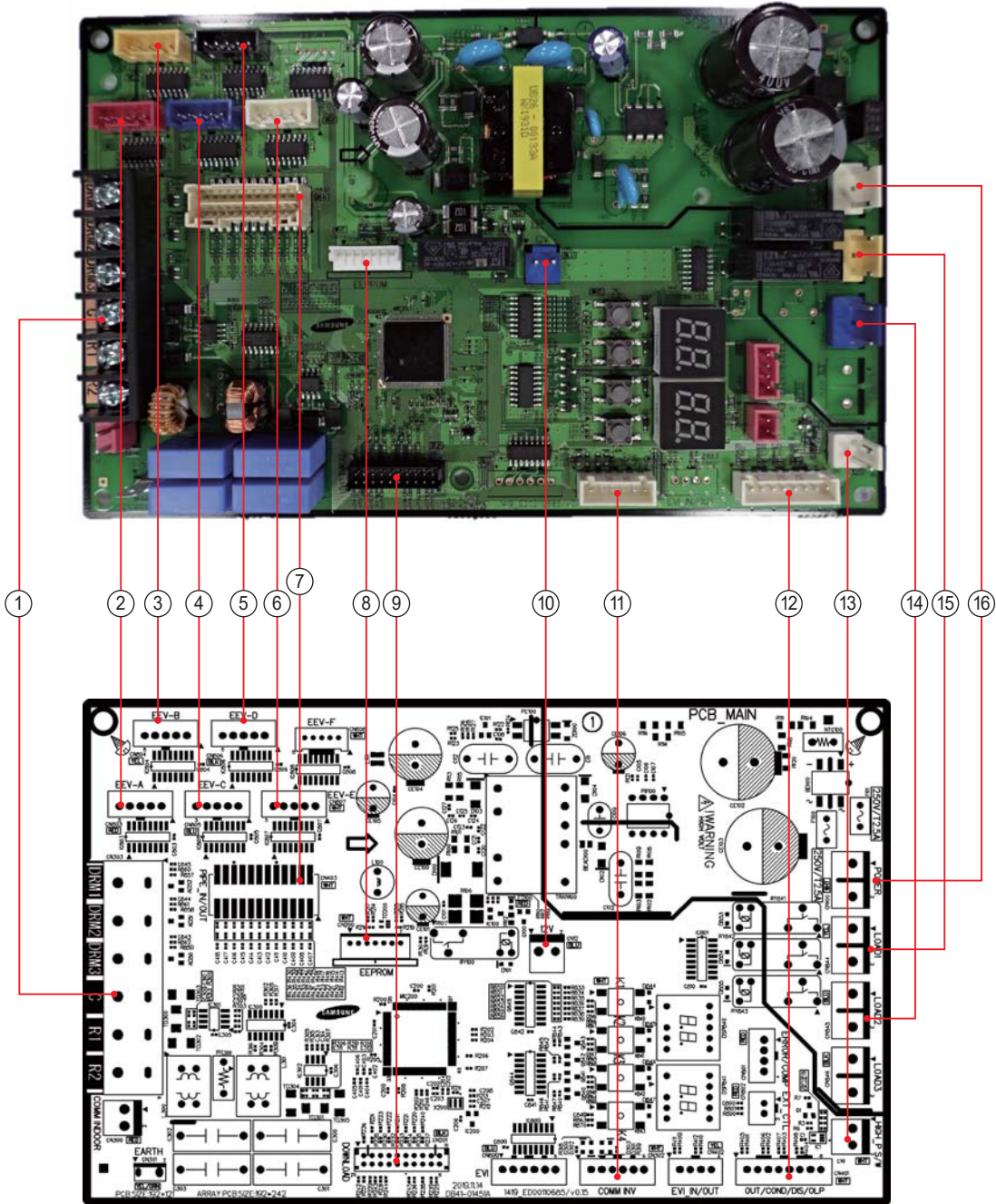

1. CN303 - DRED & UPPER CTRL	2. CN803 - EEV A	3. CN804 - EEV B	4. CN805 - EEV C
#1 : DRED SIGNAL(DRM1) #2 : DRED SIGNAL(DRM2) #3 : DRED SIGNAL(DRM3) #4 : GND #5 : R1 #6 : R2	#1 : EEV A SIGNAL #2 : EEV A SIGNAL #3 : EEV A SIGNAL #4 : EEV A SIGNAL #5 : GND	#1 : EEV B SIGNAL #2 : EEV B SIGNAL #3 : EEV B SIGNAL #4 : EEV B SIGNAL #5 : GND	#1 : EEV C SIGNAL #2 : EEV C SIGNAL #3 : EEV C SIGNAL #4 : EEV C SIGNAL #5 : GND
5. CN806 - EEV D	6. CN807 - EEV E	7. CN403 - PIPE IN/OUT TEMPERATURE SENSOR	
#1 : EEV D SIGNAL #2 : EEV D SIGNAL #3 : EEV D SIGNAL #4 : EEV D SIGNAL #5 : GND	#1 : EEV E SIGNAL #2 : EEV E SIGNAL #3 : EEV E SIGNAL #4 : EEV E SIGNAL #5 : GND	#1 : PIPE IN-A TEMPERATURE SENSOR #3 : PIPE IN-B TEMPERATURE SENSOR #5 : PIPE IN-C TEMPERATURE SENSOR #7 : PIPE IN-D TEMPERATURE SENSOR #9 : PIPE IN-E TEMPERATURE SENSOR	#13 : PIPE OUT-A TEMPERATURE SENSOR #15 : PIPE OUT-B TEMPERATURE SENSOR #17 : PIPE OUT-C TEMPERATURE SENSOR #19 : PIPE OUT-D TEMPERATURE SENSOR #21 : PIPE OUT-E TEMPERATURE SENSOR #2,4,6,8,10,12 : GND #14,16,18,20,22,24 : GND #11,23 : -
8. CN200 - EEPROM	9. CN201 - DOWNLOAD	10. CN12 - 12V	11. CN302 - MAIN ↔ INV COMMUNICATION
#1 : GND #2 : - #3 : 5V #4 : EEPROM SIGNAL #5 : EEPROM SIGNAL #6 : EEPROM SIGNAL #7 : EEPROM SIGNAL	#1~20 : DOWNLOAD SIGNAL	#1 : DC 12V #2 : GND	#1 : TXD #2 : RXD #3 : GND #4 : DC 5V #5 : DC 12V #6 : INV POWER CTRL
12. CN401 - TEMPERATURE SENSOR	13. CN1 - HIGH PRESSURE SWITCH	14. CN100 - AC LOAD POWER	15. CN844 - 4WAY VALVE
#1 : OUTDOOR TEMPERATURE SENSOR #3 : CONDENSOR TEMPERATURE SENSOR #5 : DISCHARGE TEMPERATURE SENSOR #7 : OLP TEMPERATURE SENSOR #2,4,6,8 : GND	#1 : HIGH PRESSURE SWITCH INPUT SIGNAL #2 : GND	#1 : L - LIVE POWER INPUT #2 : - #3 : N - NEUTRAL POWER INPUT	#1 : L - RELAY CONTACT OUTPUT #2 : - #3 : N - NEUTRAL POWER OUTPUT
16. CN845 - BASE HEATER			
#1 : L - RELAY CONTACT OUTPUT #2 : - #3 : N - NEUTRAL POWER OUTPUT			

■ AJ020TXS3CH, AJ***TX*4CH, AJ***TX*5CH (MAIN PBA)

- This Document can not be used without Samsung's authorization.

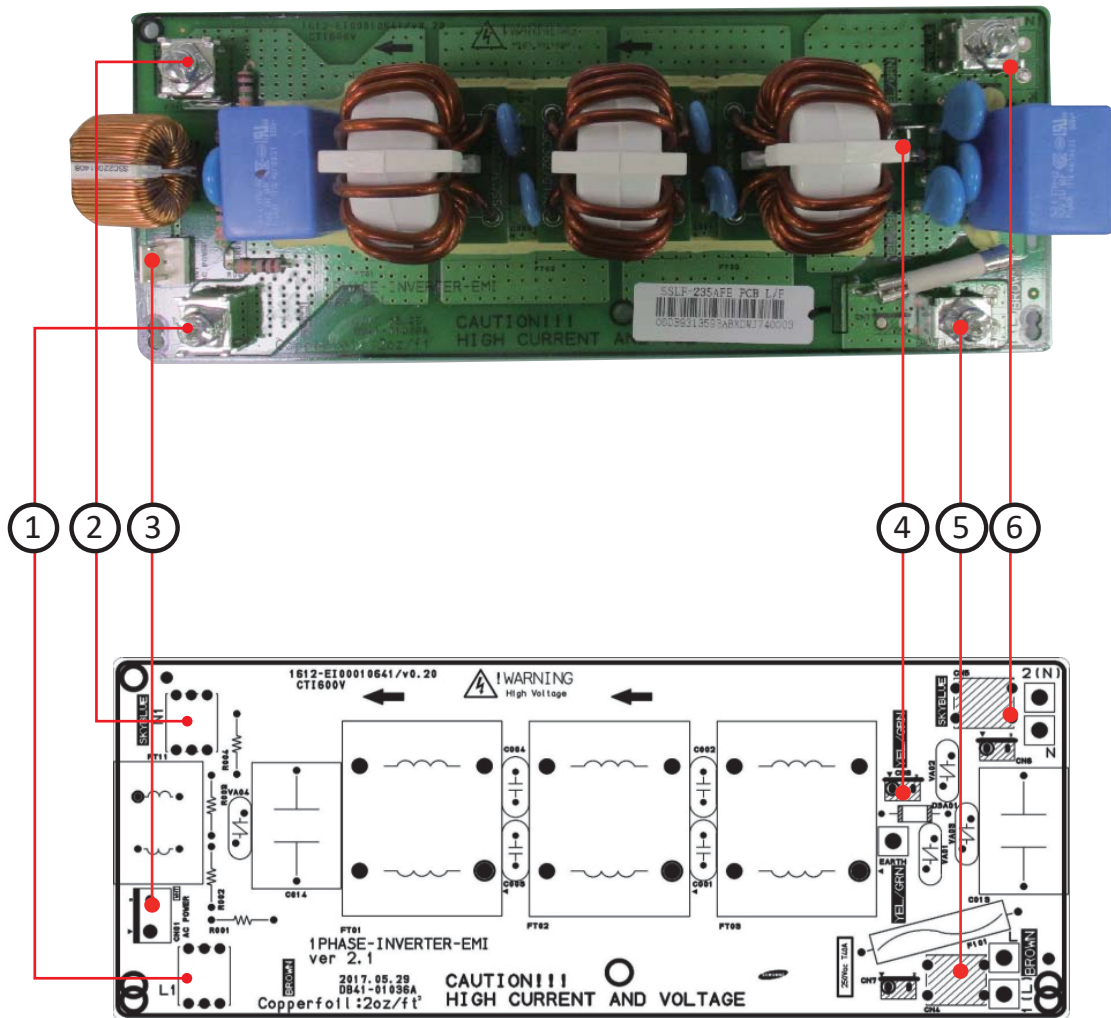

1. L1 - AC POWER OUTPUT	2. L2 - AC POWER OUTPUT	3. CN01 - AC POWER OUTPUT	4. EARTH
#1 : L - RELAY CONTACT OUTPUT	#1 : N - NEUTRAL POWER OUTPUT	#1 : L - RELAY CONTACT OUTPUT #2 : - #3 : N - NEUTRAL POWER OUTPUT	#1 : EARTH
5. L, 1(L) - AC POWER INPUT	6. N, 2(N) - AC POWER INPUT		
#1 : L - LIVE POWER INPUT	#1 : N - NEUTRAL POWER INPUT		

6. Wiring Diagram

6-1 Indoor Unit

■ Mini 4Way

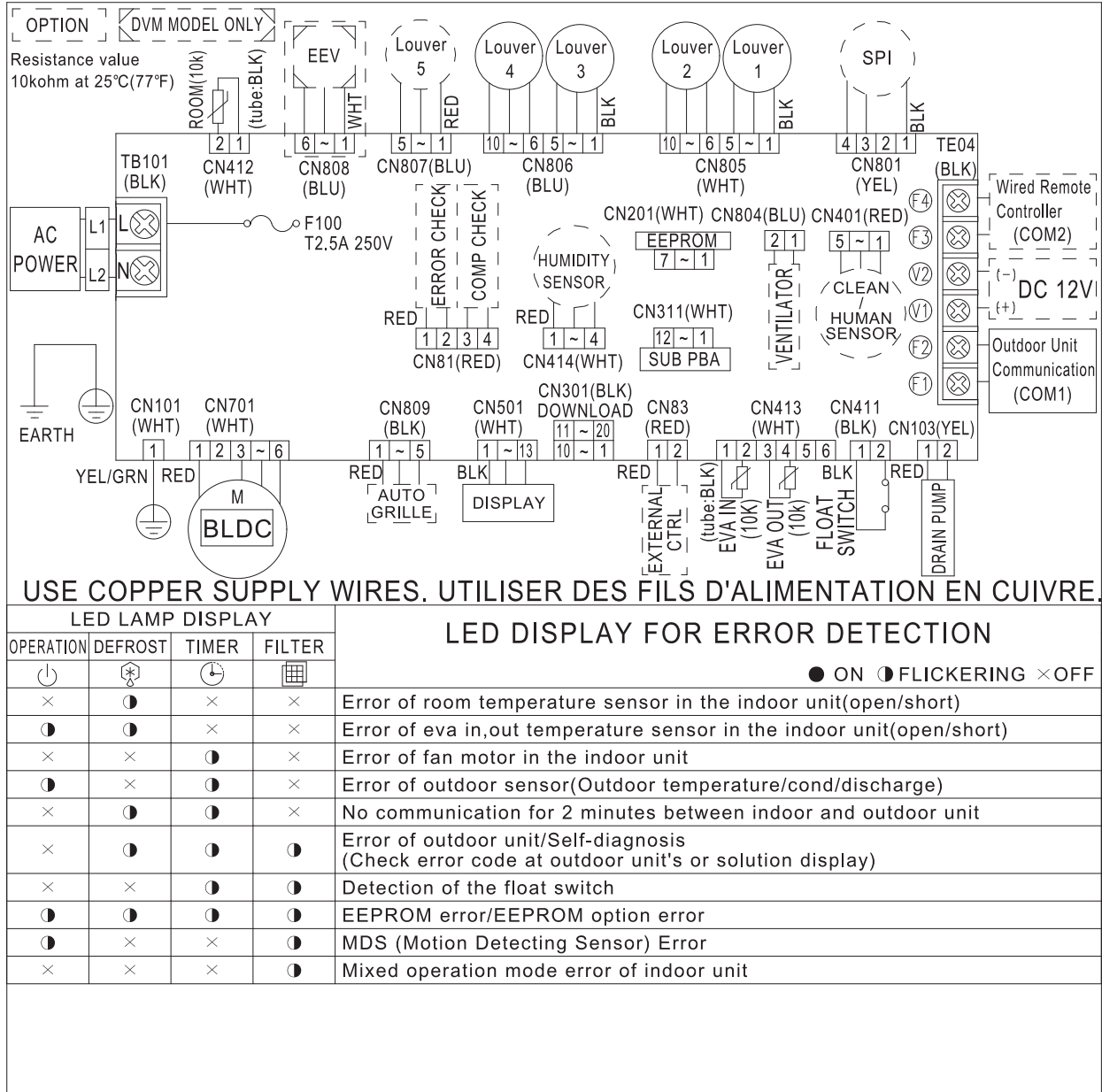

This Document can not be used without Samsung's authorization.

■ Home Duct

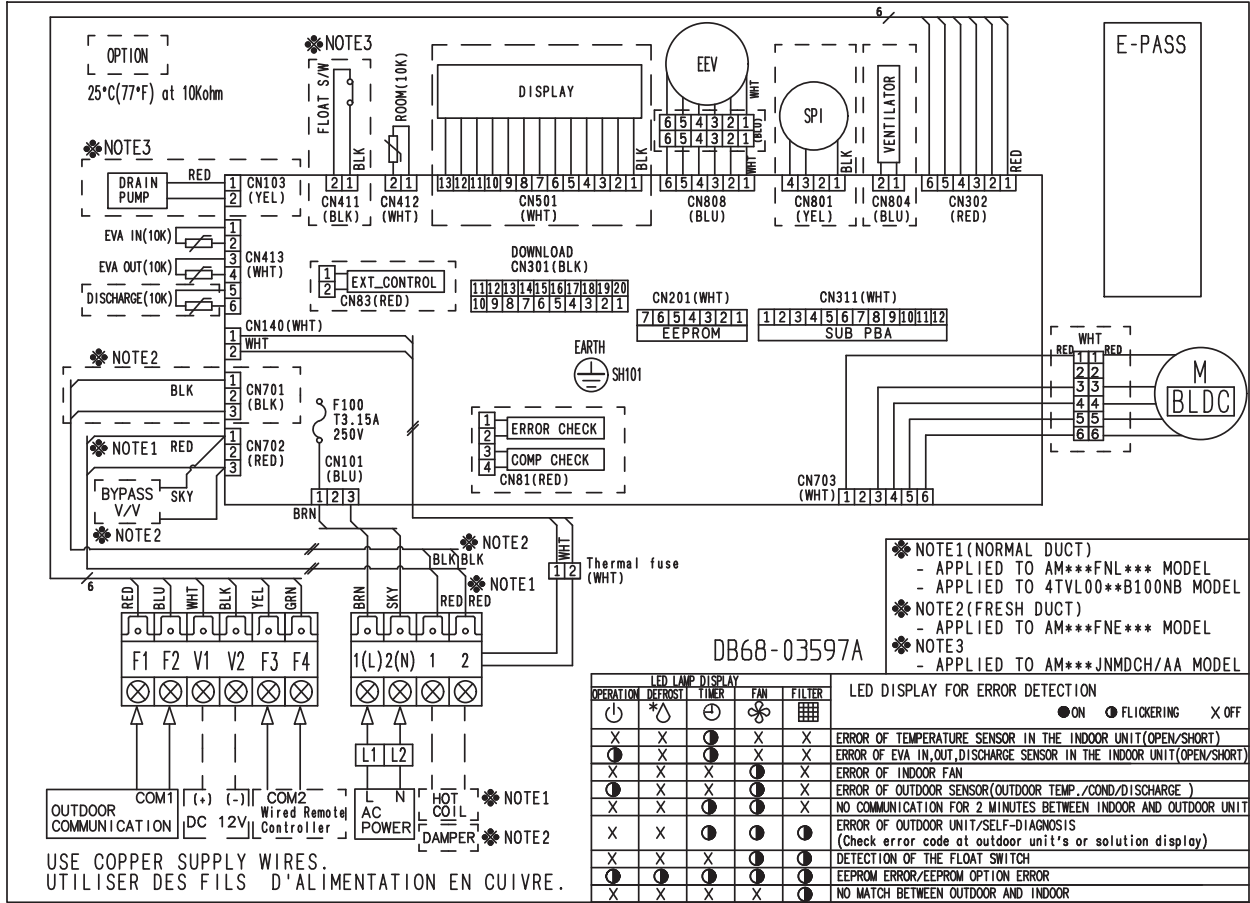

This Document can not be used without Samsung's authorization.

■ Console

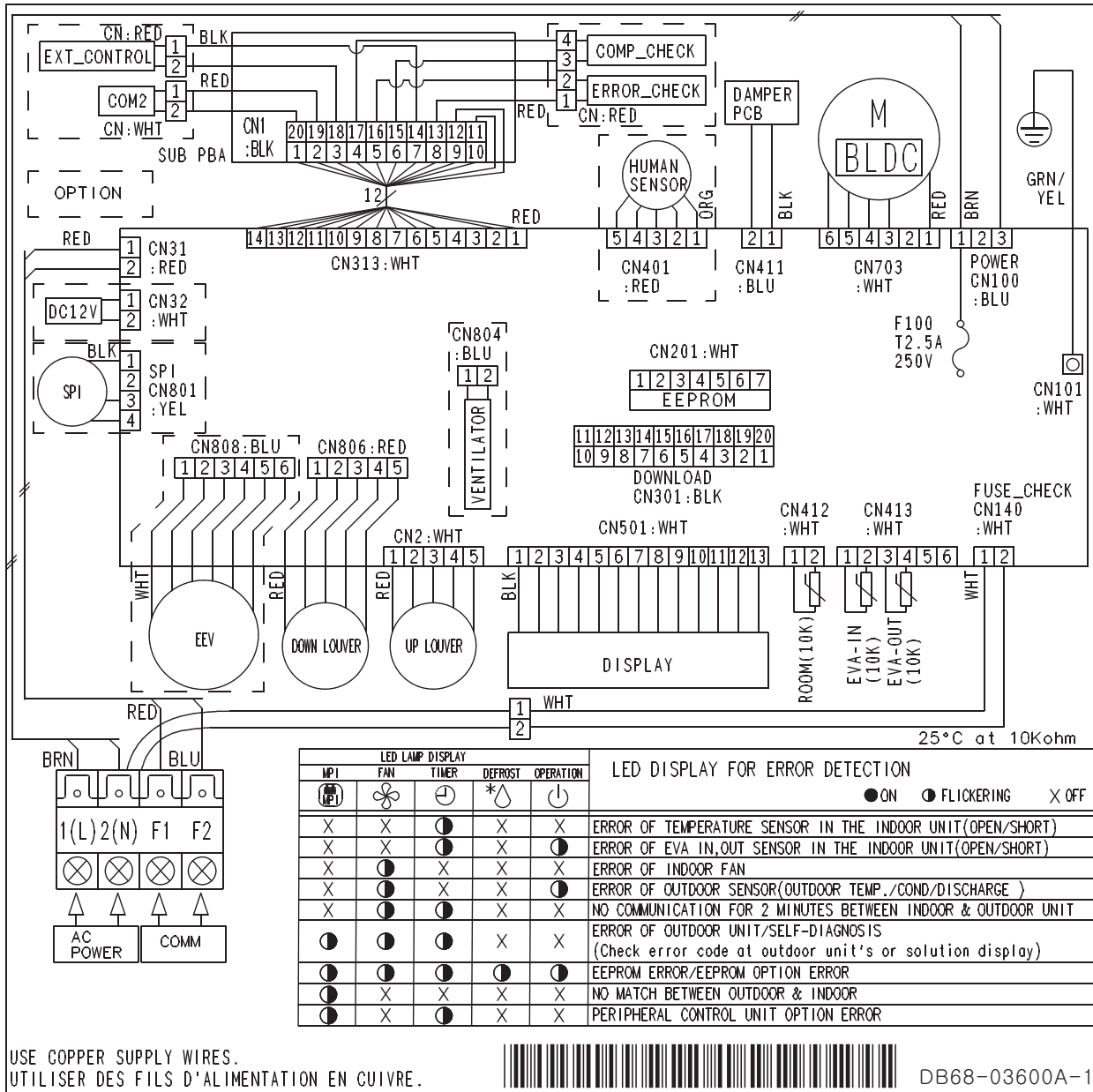

This Document can not be used without Samsung's authorization.

6-2 Outdoor unit

■ AJ020TXJ2CH, AJ024TXJ3CH

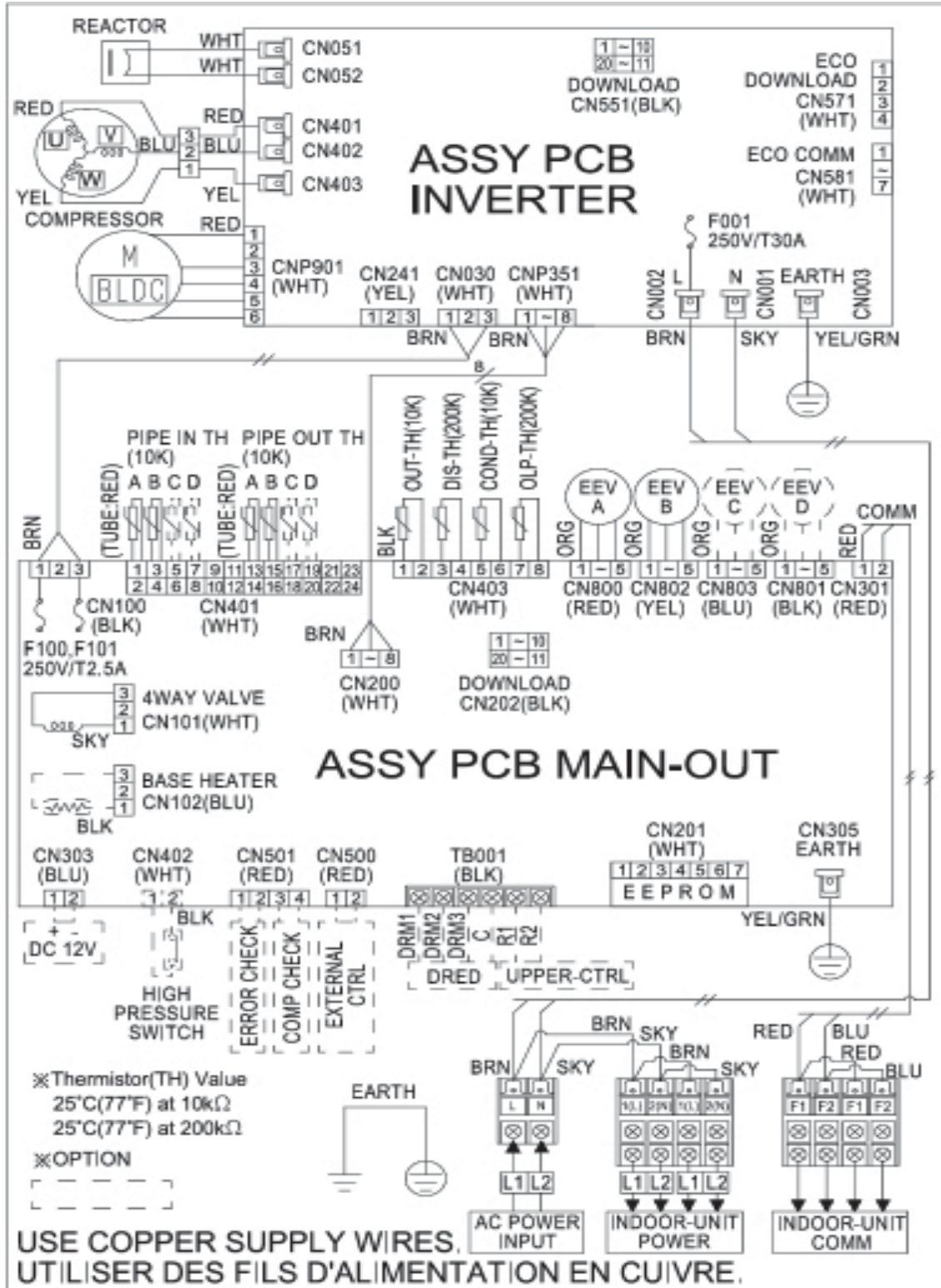

This Document can not be used without Samsung's authorization.

■ AJ020TXS3CH, AJ***TX*4CH, AJ***TX*5CH

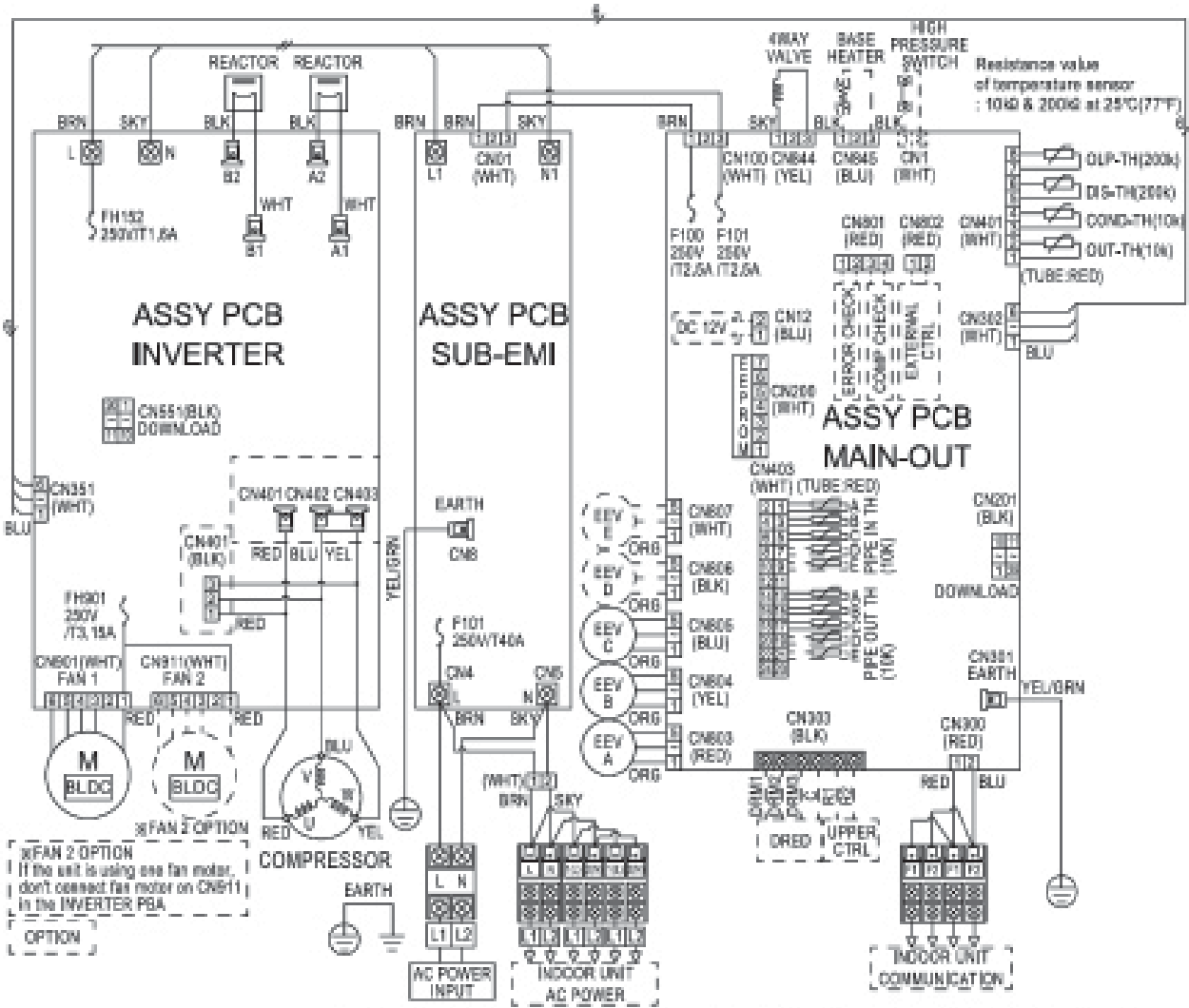

This Document can not be used without Samsung's authorization.

7. Preference Sheet

7-1 Selecting Area for Installation

Select an area for installation that is suitable to customer's needs.

7-1-1 Indoor Unit

1. Make sure that you install the indoor unit in an area providing good ventilation. It must not be blocked by an obstacle affecting the airflow near the air inlet and the air outlet.
2. Make sure that you install the indoor unit in an area allowing good air handling and endurance of vibration of the indoor unit.
3. Make sure that you install the indoor unit in an area where there is no source of heat or vapor nearby.
4. Make sure that you install the indoor unit in an area from which hot or cool air is spread evenly in a room.
5. Make sure that you install the indoor unit in an area away from TVs, audio units, cordless phones, fluorescent lighting fixtures and other electrical appliances (at least 1 meter).
6. Make sure that you install the indoor unit in an area which provides easy pipe connection with the outdoor unit, and easy drainage for condensed water.
7. Make sure that you install the indoor unit in an area which is large enough to accommodate the measurements shown in figure on the next page.



- It is harmful to the air conditioner if it is used in the following environments: greasy areas (including areas near machines), salty areas such as coast areas, areas where sulfuric gas is present such as hot spring areas. Contact your dealer for advice.

- Minimum installation height of indoor unit is 0.6 m for floor mounted, 1.8 m for wall, 2.2 m for ceiling.

7-1-2 Outdoor Unit

1. Make sure that you install the outdoor unit in an area not exposed to the rain or direct sun light. (Install a separate sunblind if exposed to direct sun light.)
2. Make sure that you install the outdoor unit in an area allowing the good air moment, not amplifying noise or vibration, especially to avoid distrubing neighbors. (Fix the unit firmly if it is mounted in a high place.)
3. Make sure that you install the outdoor unit in an area providing the good ventilation and which is not dusty. It must not be blocked by any dbstacle affecting the airflow near the air inlet and the air outlet.
4. Make sure that you install the outdoor unit in an area free from animals or plants.
5. Make sure that you install the outdoor unit in an area not blocking traffic.
6. Make sure that you install the outdoor unit in an area easy to drain condensed water from the indoor unit.
7. Make sure that you install the outdoor unit in an area which provieds easy connection within the maximum allowable length of a coolant pipe.
If you install the excessive length of pipe, add additional refrigerant as 10 g or 20 g per unit meter; refer to the table below.

Model Name	Total connecting pipe length (L)		Adding refrigerant
AJ020TXJ2CH	(LT) ft	≤ 98.4 ft	Chargeless
		≥ 98.4 ft	(LT-98.4) ft x 0.11 oz
AJ024TXJ3CH	(LT) ft	≤ 131.2 ft	Chargeless
		≥ 131.2 ft	(LT-131.2) ft x 0.11 oz
AJ020TXS3CH AJ024TXS4CH AJ030TXS4CH AJ036TXJ4CH	(LT) ft	≤ 131.2 ft	Chargeless
		> 131.2 ft	(LT-131.2) ft x 0.22 oz
AJ036TXS5CH AJ048TXJ5CH	(LT) ft	≤ 164.0 ft	Chargeless
		> 164.0 ft	(LT-164.0) ft x 0.22 oz

8. Make sure that you install the outdoor unit in an area which is large enough to accommodate the measurements shown in figure on the next page.

7-1-3 Remote Control Unit

1. Make sure that you use the remote control unit in an area free from obstacles such as curtains etc, which may block signals from the remote control unit.
2. Make sure that you put the remote control unit in an area not exposed to direct sunlight, and where there is no source of heat.
3. Make sure that you use the remote control unit in an area away from TVs, audio units, cordlessphones, fluorescent lighting.

7-2 Connecting Up and Purging the Circuit



- When installing, make sure there is no leakage. When recovering the refrigerant, ground the compressor first before removing the connection pipe. If the refrigerant pipe is not properly connected and the compressor works with the service valve open, the pipe inhales the air and it makes the pressure inside of the refrigerant cycle abnormally high. It may cause explosion and injury.

The outdoor unit is loaded with sufficient R-410A refrigerant. Do not vent R-32 into atmosphere: it is a fluorinated greenhouse gas, covered by Kyoto Protocol, with a Global Warming Potential (GWP) = 2088.

You should purge the air in the indoor unit and in the pipe. If air remains in the refrigerant pipes, it affects the compressor. It may cause reduction of cooling capacity and malfunction. Refrigerant for air purging is not charged in the outdoor unit. Use Vacuum Pump as seen in the picture.

1. Check the piping connections.
2. Connect the charging hose of low pressure side of manifold gauge to the packed valve having a service port .



- Make the electrical connection and leave the system into "stand by mode". Do not turn on the system! This is necessary for better vacuum operation (full OPEN position of Electronic Expansion Valve - EEV-).

Model Name	Valve	
	3/8"	1/2"
AJ020TXJ2CH	1	1
AJ024TXJ3CH	1	2
AJ020TXS3CH	3	-
AJ024TXS4CH	2	2
AJ030TXS4CH		
AJ036TXS4CH		
AJ036TXJ4CH		
AJ048TXJ5CH		
		3

3. Open the valve of the low pressure side of manifold gauge counter clockwise.
4. Purge the air from the system using vacuum pump for about 30 minutes.
 - Close the valve of the low pressure side of manifold gauge clockwise.
 - Make sure that pressure gauge show -0.1MPa(-76cmHg) after about 1 hour. This procedure is very important in order to avoid gas leak.
 - Turn off the vacuum pump.
 - Remove the hose of the low pressure side of manifold gauge.
5. Set spindle of both liquid side and gas side of stop valve to the open position.
6. Mount the valve stem nuts and the service port cap to the valve, and tighten them with a torque wrench.

Outer diameter (mm)	Tightening torque	
	Body cap (N · m)	Charging port cap (N · m)
ø 6.35	20 to 25	10 to 12
ø 9.52	20 to 25	
ø 12.70	25 to 30	
ø 15.88	30 to 35	

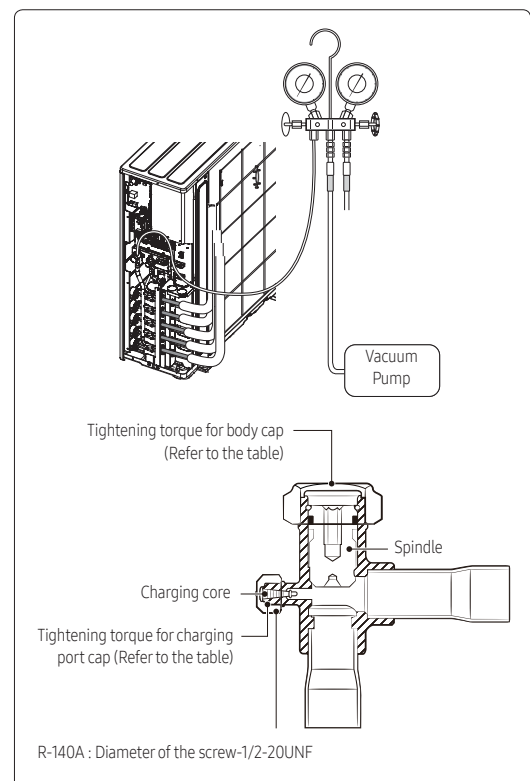
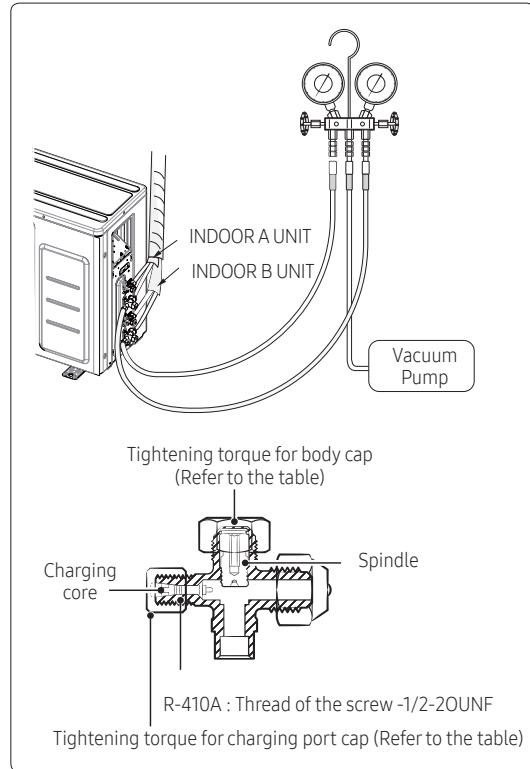

7-3 Refrigerant Refill

Refill an air conditioner with refrigerant when refrigerant has been leaked at installing or using.

1) Purge air(for new installation only).



2) Turn the 3 way valve clockwise to close, connect the pressure gauge (low pressure side) to the service valve, and open the 3 way valve again.



3) Connect the tank to refill with refrigerant.



4) Set the unit to cool operation mode.



5) Check the pressure indicated by the pressure gauge(low pressure side).

* Standard pressure should be 8.0~9.0kg/cm2 in a regular and high operation mode.



6) Open the refrigerant tank and fill with refrigerant until the rated pressure is reached.

* It is recommended not to pour the refrigerant in too quickly, but gradually while operating a pressure valve.



7) Stop operation of the air conditioner.



8) Close the 3 way valve, disconnect the pressure gauge, and open the 3 way valve again.



9) Close the cap of each valve.

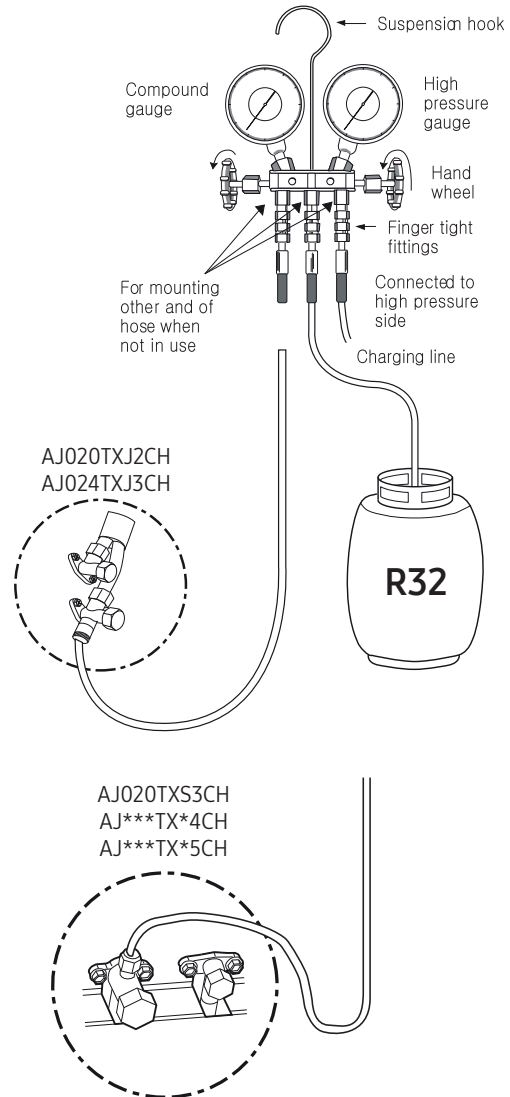

7-4 Refrigerant Adjustment

Class	At installation		At service	
	Air-Purge Method	Refrigerant Adjustment	Air-Purge Method	Refrigerant Quantity
Total Connecting Pipe Length (LT)				
LT ≤ 30m AJ***TX**CH	Refer to the detailed Connecting up and purging the circuit. (8-2 page)	Unnecessary	Purge air using a vacuum pump or an additional refrigerant cylinder.	Refer to specification sheet
30m ≤ LT ≤ 70m AJ020TXJ2CH, AJ024TXJ3CH		Add "10g" of refrigerant (R-410A) for every 1m		Add "10g" of refrigerant (R-410A) for every 1m
30m ≤ LT ≤ 75m AJ020TXS3CH, AJ***TX*4CH, AJ***TX*5CH		Add "20g" of refrigerant (R-410A) for every 1m		Add "20g" of refrigerant (R-410A) for every 1m

It would be the best choice to use the standard tube length to keep the basic quality of Room Air conditioner, for example cooling and heating capacity, sound level, vibration level, and reliability.

But, according to a certain different installation condition, the connection tube length could be changed in the recommendation length that is shown above.

In this case, installer should keep the installation condition to keep the quality of Room Air conditioner.

- Refrigerant should be charged additionally as written above according to the change of the length of the connection tube. It needs to affect the decrease in cooling and heating capacity or of the reliability of compressor that may be caused by a lack of refrigerant.
- Installation position difference between the indoor unit and the outdoor unit should not exceed over than 15 meters.
- When the connection pipe is been extended longer than 5 meters, it might need to change the diameter of the electrical wire to a larger size in order to keep a voltage drop for starting room air conditioner is not less than 85% of the rated voltage. And then, a voltage meter will be useful to check the rate of the voltage drop.

7-5 Flare Nut Fixing Torque

Outer diameter (mm)	Tightening torque	
	Body cap (N · m)	Charging port cap (N · m)
ø 6.35	20 to 25	10 to 12
ø 9.52	20 to 25	
ø 12.70	25 to 30	
ø 15.88	30 to 35	

7-6 "Pump down" Procedure

Pump down will be carried out when an evaporator is replaced or when the unit is relocated in another area.



WARNING

- After installing the product, be sure to perform leak tests on the piping connections. After pumping down refrigerant to inspect or relocate the outdoor unit, be sure to stop the compressor and then remove the connected pipes.
 - Do not operate the compressor while a valve is open due to refrigerant leakage from a pipe or an unconnected or incorrectly connected pipe. Failure to do so may cause air to flow into the compressor and too a high pressure to develop inside the refrigerant circuit, leading to an explosion or product malfunction.

Pump-down is an operation intended to collect all the system refrigerant in the outdoor unit. This operation must be carried out before disconnecting the refrigerant pipe in order to avoid refrigerant loss to the atmosphere.

1. Turn the system on in cooling with fan operating at high velocity and then let the compressor run for more than 5 minutes. (Compressor will immediately start, provided 3 minutes have elapsed since the last stop.)
2. Release the valve caps on High and Low pressure side.
3. Use L-wrench to close the valve on the high pressure side.
4. After approximately 2 minute, close the valve on the low pressure side.
5. Stop operation of the air conditioner by pressing the (Power) button on the indoor unit or remote control.
6. Disconnect the pipes.

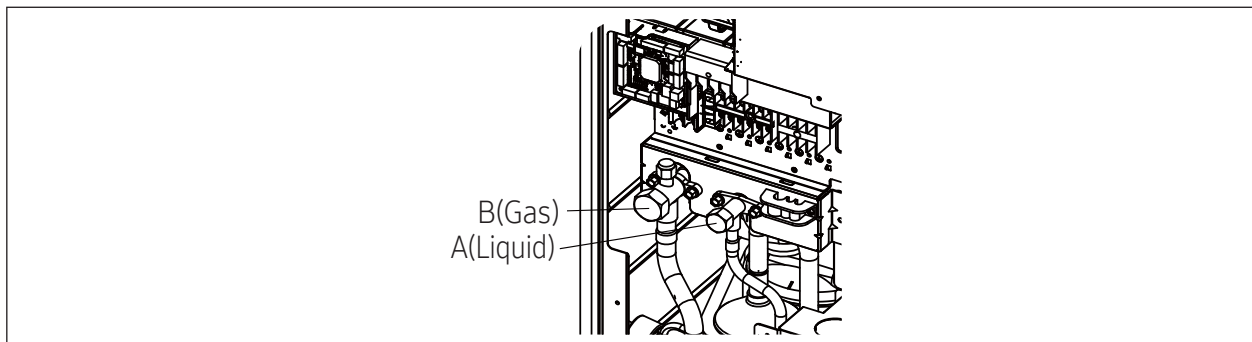

※ The design and shape can be changed according to the model.



Remarks

Relocation of the air conditioner.

- Refer to this procedure when the unit is relocated.
 1. Carry out the pump down procedure (refer to the details of 'pump down').
 2. Remove the power cord.
 3. Disconnect the assembly cable from the indoor and outdoor units.
 4. Remove the flare nut connecting the indoor unit and the pipe. At this time, cover the pipe of the indoor unit and the other pipe using a cap or vinyl plug to avoid foreign material entering.
 5. Disconnect the pipe connected to the outdoor unit.
 4. At this time, cover the valve of the outdoor unit and the other pipe using a cap or vinyl plug to avoid foreign material entering.
 6. Make sure you do not bend the connection pipes in the middle and store together with the cables.
 7. Move the indoor and outdoor units to a new location.
 8. Remove the mounting plate for the indoor unit and move it to a new location.

7-7 Index of Model Name

■ Indoor (RAC)

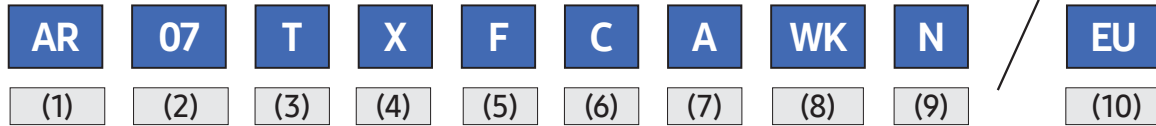

(1) Model		(5) Feature		(8) Color	
AR	RAC	A	MDS + PM1.0 Filter + PM1.0 Sensor + Wi-Fi	WK	DA White
		B	MDS + PM1.0 Filter + Wi-Fi		
		C	MDS + Wi-Fi + Tri-care Filter		
		D	MDS + Wi-Fi		
		E	Wi-Fi + Tri-care Filter		
		F	Wi-Fi		
		G	Tri-care Filter		
		H	-		
(2) Capacity		(6) Design		(9) Product	
**	X1,000 Btu/h (2digits)	A	Wind-Free, GEO	N	Indoor
		C	Wind-Free, AIRISE		
		Y	GEO		
		Z	AIRISE		
(3) Year		(10) Buyer			
F	2013	AA	America		
H	2014	EU	Europe		
J	2015				
K	2016				
M	2017				
N	2018				
R	2019				
T	2020				
(4) Inverter type					
S	HP, R410A				
X	HP, R32				

■ Indoor (SAC)

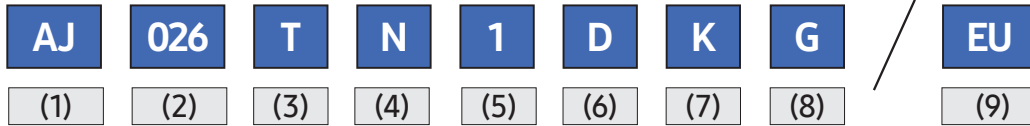

(1) Model	
AM	DVM
AJ	FJM
AC	CAC

(2) Capacity	
**	X1,000 Btu/h (2digits)

(3) Year	
F	2013
H	2014
J	2015
K	2016
M	2017
N	2018
R	2019
T	2020

(4) Inverter type	
N	Indoor unit (NASA)
X	Outdoor unit (NASA)
B	Indoor unit (Non NASA)
C	Outdoor unit (Non NASA)

(5) Indoor Type	
1	1Way
J	Console
N	MINI 4 WAY CST
M	MSP DUCT
L	LSP DUCT

(6) Grade	
D	DELUXE

(7) Rating voltage			
A	115,60Hz, 1Φ	H	380V, 60Hz, 3Φ
B	220V, 60Hz	J	460V, 60Hz, 3Φ
C	208~230, 60Hz	K	220~240V, 50/60Hz
D	200~220V, 50Hz	F	208~230V, 60Hz, 3Φ
E	220~240V, 50Hz	M	127V, 50Hz
F	208~230V, 60Hz, 3Φ	N	380~415, 50/60Hz, 3Φ
G	380~415V, 50Hz, 3Φ		

(8) Mode / Refrigerant		
C	Cooling only	R410A
H	Heat pump	
R	Heat recovery	
D	Cooling only	R22
E	Heat pump	
A	Cooling only	R134A R32
G	Heat pump	

(9) Buyer	
AA	America
EU	Europe

■ Outdoor Unit

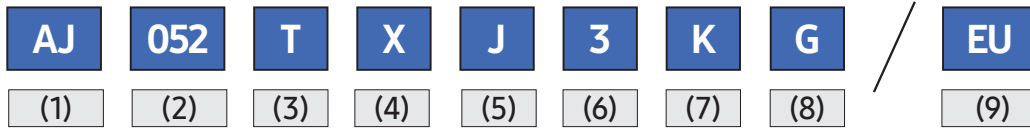

(1) Model	
AM	DVM
AJ	FJM
AC	CAC
AR	RAC

(2) Capacity	
***	X1/10HP (3digits)
***	X1/10kW (3digits)
***	X1,000 Btu/h (3digits)

(3) Year	
F	2013
H	2014
J	2015
K	2016
M	2017
N	2018
R	2019
T	2020

(4) Product type	
N	Indoor unit (NASA)
X	Outdoor unit (NASA)
B	Indoor unit (Non NASA)
C	Outdoor unit (Non NASA)

(5) Product notation	
V	DVM Inverter
A	CAC Inv+Side+T1
J	FJM

(6) Max room number	
2	2 rooms
3	3 rooms
4	4 rooms
5	5 rooms

(7) Rating voltage			
A	115,60Hz, 1Φ	H	380V, 60Hz, 3Φ
B	220V, 60Hz	J	460V, 60Hz, 3Φ
C	208~230, 60Hz	K	220~240V, 50/60Hz
D	200~220V, 50Hz	F	208~230V, 60Hz, 3Φ
E	220~240V, 50Hz	M	127V, 50Hz
F	208~230V, 60Hz, 3Φ	N	380~415, 50/60Hz, 3Φ
G	380~415V, 50Hz, 3Φ		

(8) Mode / Refrigerant		
C	Cooling only	R410A
H	Heat pump	
R	Heat recovery	
D	Cooling only	R22
E	Heat pump	
A	Cooling only	R134A R32
G	Heat pump	

(9) Buyer	
AA	America
EU	Europe

7-8 Refrigerating Cycle Diagram

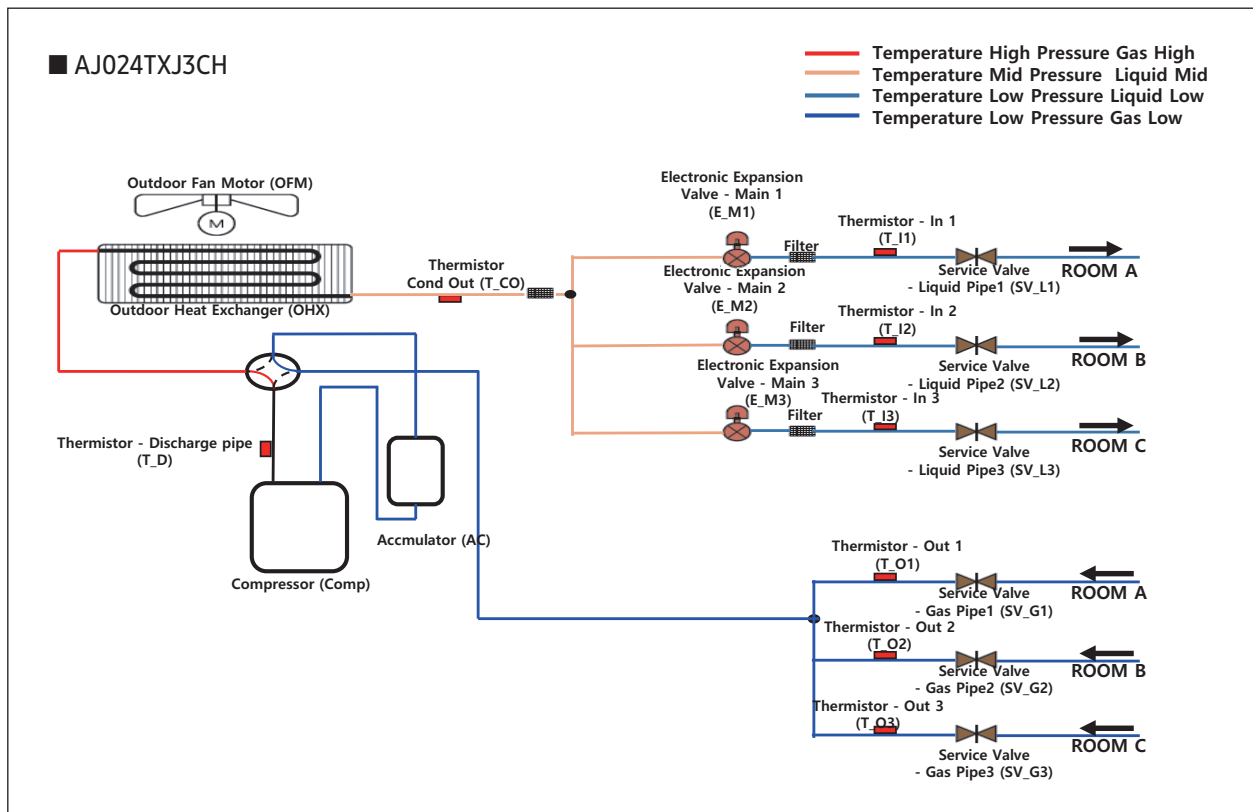
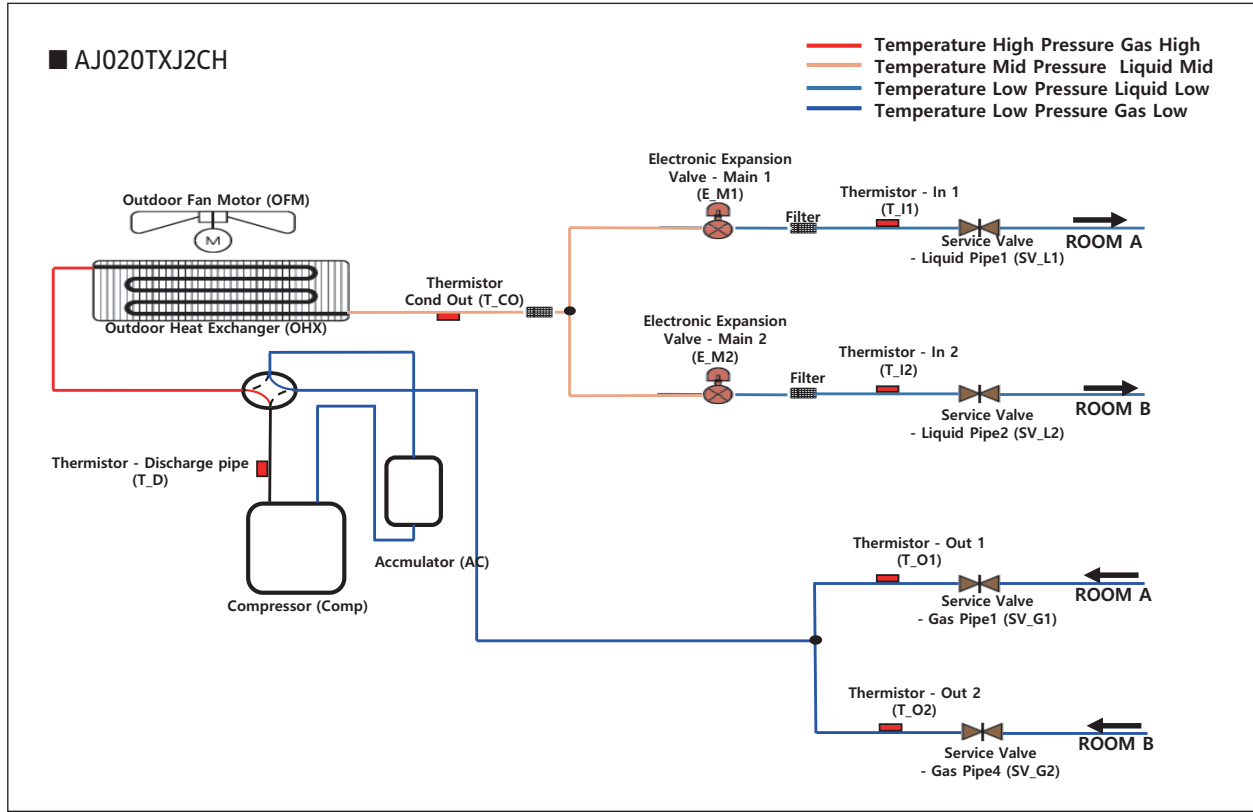

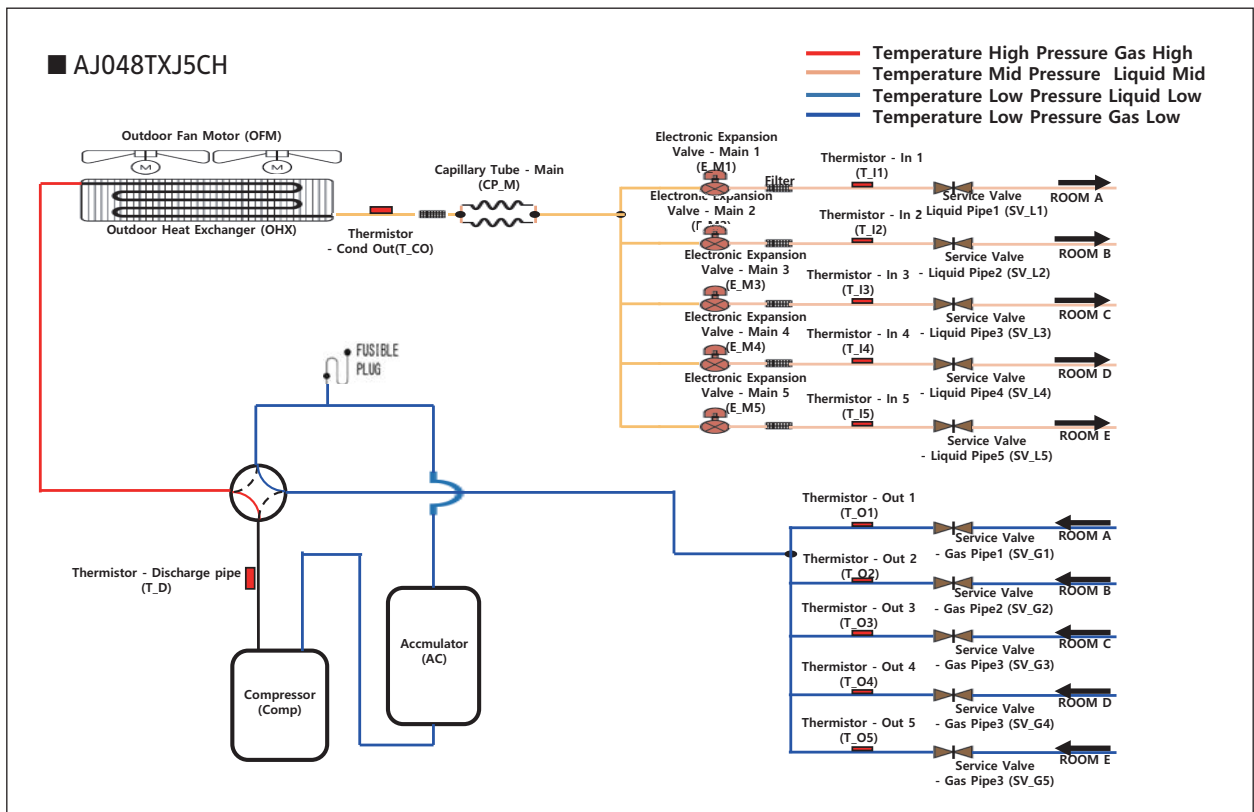
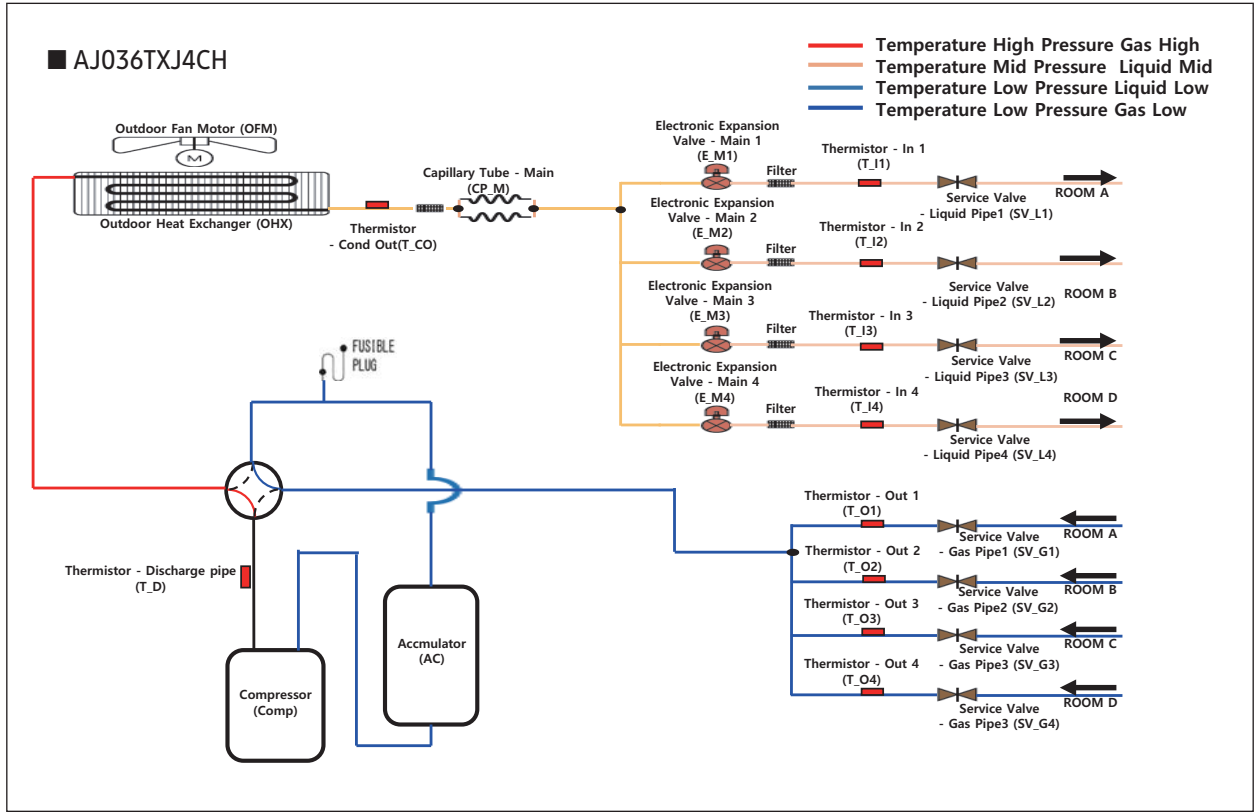

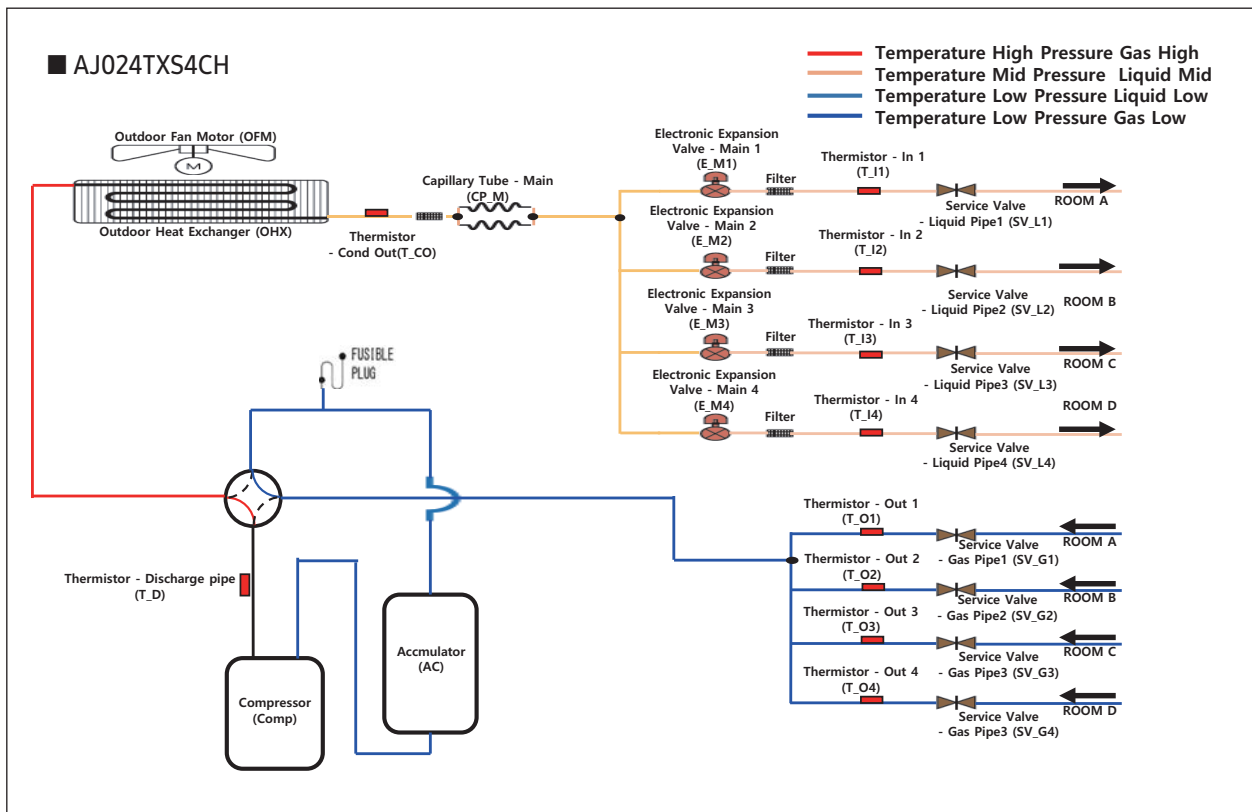
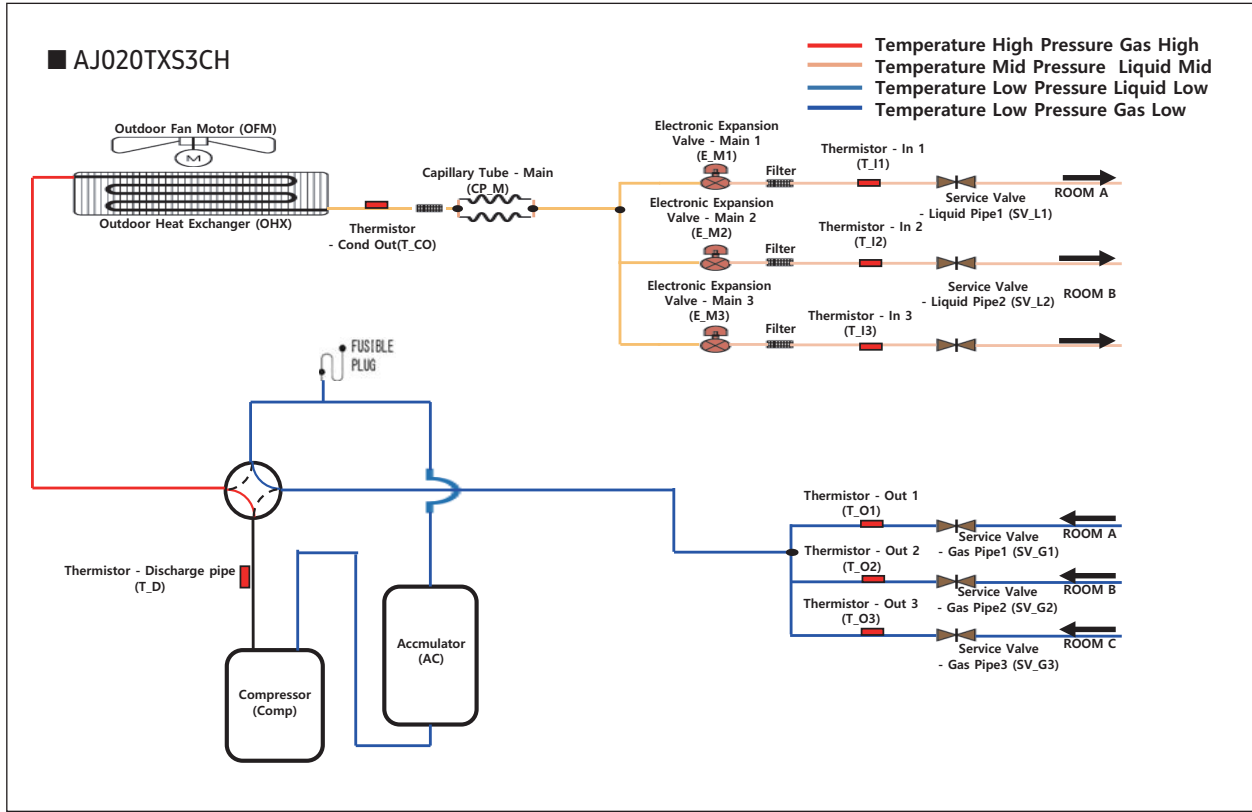

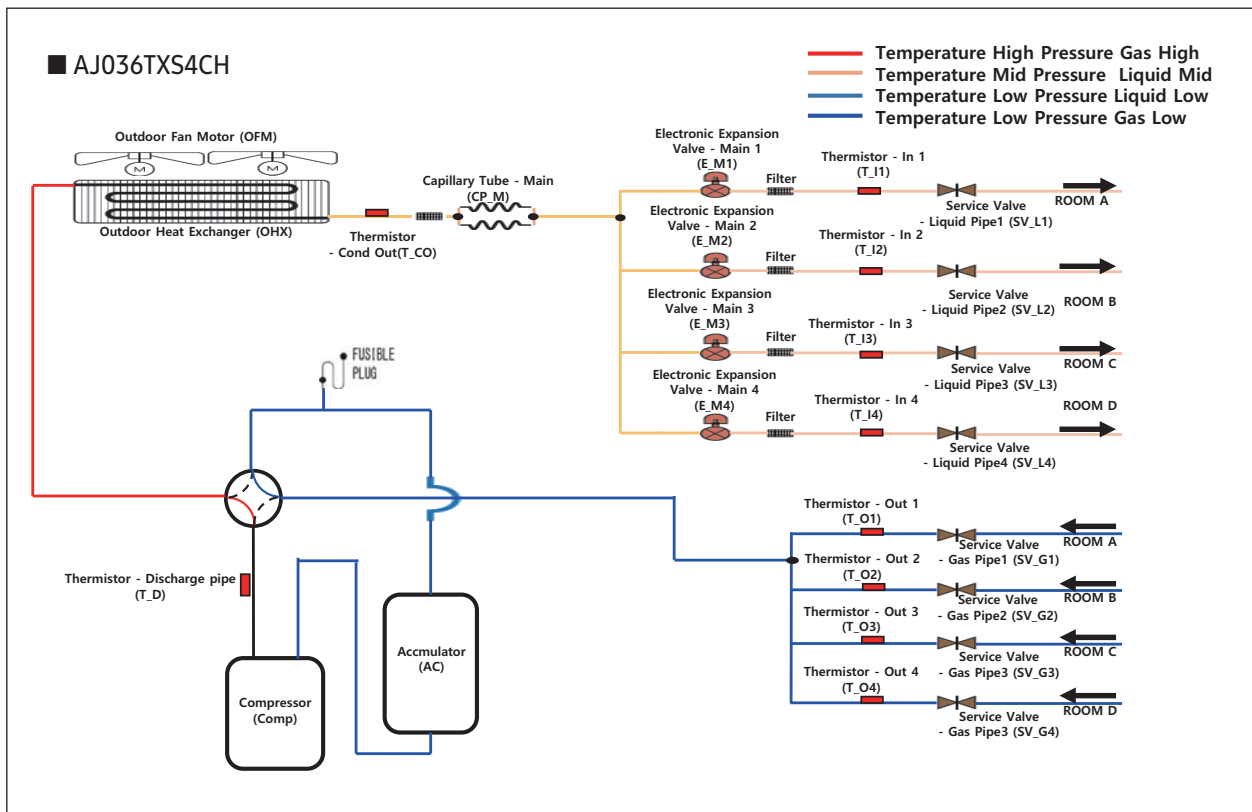
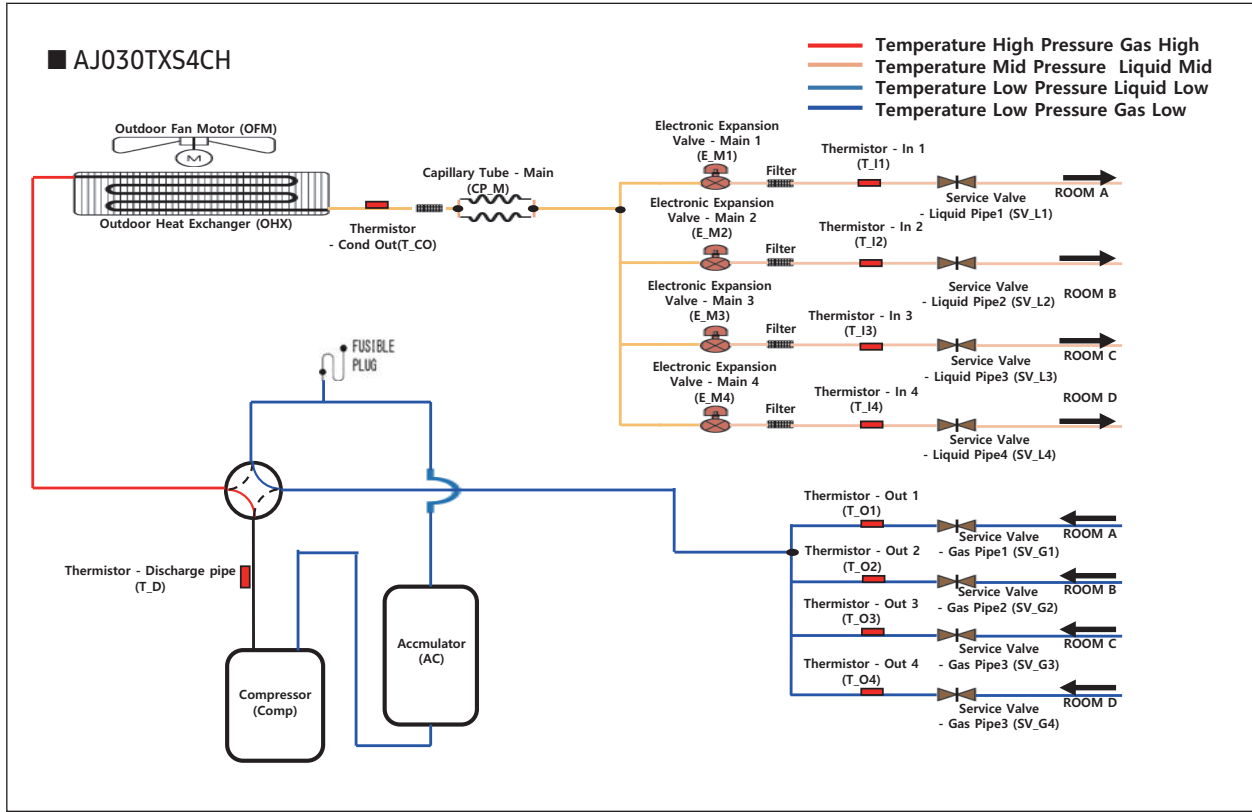

7-9 Pressure & Capacity mark

W	cal/s	kcal/h	Btu/h	HP	kg.m/s	ib.m/s
1	0.23885	0.85985	3.4121	0.001341	0.10197	0.73756
4.1868	1	3.6	14.286	0.0056146	0.42693	3.088
1.163	0.27778	1	3.9683	0.0015596	0.11859	0.85778
0.29307	0.06999	0.252	1	3.9302x10 ⁻⁴	0.029885	0.21616
745.7	178.11	641.19	2,544.4	1	76.04	550
9.8067	2.3423	8.4322	33.462	0.013151	1	7.233
1.3558	0.32383	1.1658	4.6262	0.0018182	0.13826	1

7-10 The abbreviated technology words & the definition of technology terms

Abbreviated technology words	Definition of technology terms
COMP (Full name compressor)	One that compresses, especially a machine used to compress gases.
BLOWER	One that blows, especially a mechanical device, such as fan, produces a current of air.
FAN	A device for reeting a current of air or a breeze.
ASS'Y CONTROL BOX (Full name : Assemble control box)	A restraining device of air-condition, measure, or limit.
MOTOR	Something, such as a machine or an engine, that produces or imparts motion.
ASS'Y EVAP/ASS'Y COND (Full name : assemble evaporator / assemble condenser)	Heat exchanger; A device, used to transfer heat from a fluid on one side of a barrier to a fluid on the other side without bringing the fluids into direct contact.

7-11 Q & A for Non-trouble

Classification	Class	Description
Cooling	Q	The cooling is weak.
	A	When it is hot outside, its cooling capacity decreases due to the increase of the ambient temperature. When the dust filter gets blocked or warm outside air gets in, the cooling capacity will decrease. So, make sure to clean the dust filter frequently, prevent heat loss by closing the doors and insulate the cooling area by using curtains, blinds, shades or window tinting.
	Q	The cooling is good generally. But, it gets weak when it is considerably hot.
	A	It occurs when the outdoor unit is exposed to direct sun light and heat-up air is not ventilated well. So, set up a sun blind over the outdoor unit and keep stuff away from the unit to increase the ventilation. When the cooling capacity decreases during a heat wave, clean the heat exchanger of the outdoor unit or spray some cold water to the heat exchanger to increase the cooling capability.
	Q	The cooling is weak. Does it need refrigerant charging?
	A	It is not correct charging refrigerant regularly. Except that you have moved in several times or the connection pipes are broken, the refrigerant does not run low. So, when refrigerant is additionally charged, it could be costly and cause a product's failure. When the refrigerant leaks, all of it will escape in a short time resulting in cooling failure and no water coming out of the drain hose. So, if water comes out from the drain hose, it indicates the normal operation of the product and it does not need refrigerant charging.
	Q	It fails to do cooling.
	A	When the air conditioner is set to Ventilation or the desired temperature is set higher than the current temperature, it fails to do cooling. In this case, select Cooling or set the desired temperature lower.
Leakage	Q	It floods the floor.
	A	Place the drain hose properly. When it is not placed properly, the drain water would flow back flooding the floor. So, straighten out the drain hose for the water to be drained well.
	Q	Water drips at the drain connection (service valve) of the outdoor unit.
	A	When a glass bottle is taken out of the refrigerator, moisture gets condensed on its surface due to the temperature differences. The same principle applies to the air conditioner. When cold refrigerant goes through the copper tube, moisture gets condensed on the surface of the tube and the connection areas. To prevent the water condensation, the pipes are insulated. But, the connection areas of the outdoor unit are not insulated for the purpose of maintenance or repair, and water gets condensed due to the temperature differences and drips down. Generally, it evaporates right away. But, when it drips much during muggy days, put a water pan on the floor.
	Q	It leaks even though a drain pump is used.
	A	It occurs when the drain pump is plugged out or it is out of order. Check the power of the drain pump and the position of the drain hose, and when the pump is faulty, contact the drain pump manufacturer. Samsung Electronics do not manufacture drain pumps. So, we are not able to correct the drain pump problems.
Smells	Q	Whenever the air conditioner is turned on, it irritates my eyes and gives me a headache.
	A	There are no components in the air conditioner irritating the eyes and sending out chemical smells. But, when the air conditioner is turned on, other smell sources are sucked into the air conditioner and get out of it. So, find and root out the smell sources. Generally, it occurs at a interior renovated place, a pharmacy, a gasoline handling place, a tire shop, a second-hand book shop or an electronic component handling place; when its chemical or musty smells are sucked in and sent out, it can be misled that the air conditioner generates them. So, find and root out the problem or refresh the room frequently.

Classification	Class	Description
Smells	Q	Whenever the air conditioner is turned on, it stinks.
	A	There are no components in the air conditioner sending out chemical smells. But, when the air conditioner is turned on, other smell sources are sucked into the air conditioner and get out of it. So, find and root out the smell sources. Generally, when the drain hose is taken out to the washing room or there are sources of smells such as a diaper bin, a shoe shelf or a socks bin, bad smells generate. Also, it occurs where glass cleaners or air fresheners are used; when they are sucked in interacting with dusts and moistures inside, bad smells generate. These kinds of organic materials noxious to human bodies. So, we recommend against the use of them.
	Q	Whenever the air conditioner is turned on, it smells sour.
	A	When the room is papered recently, its paste smells would be sucked inside. Also, when the air conditioner is installed in the study room of young boys loving sweat-generating activities such as the basketball, excessive sweats evaporate and get sucked into the air conditioner resulting in bad smells. So, find and root out the problem or refresh the room frequently.
	Q	Whenever the air conditioner is turned on, it smells musty.
	A	It is due to the improper keeping of the product after its use. When keeping the product, dry up the inside with the operation of Ventilation to prevent must. When the product is kept without drying up the inside with Ventilation, mold would grow inside resulting in must. So, open the windows and switch on the Ventilation function to get rid of the saturated smell inside.
	Q	Whenever the air conditioner is turned on, it sends out bad smells such as stale smells.
	A	It occurs generally when there are pet animals in the house. Their smells stay at the same place. But, when the air conditioner is turned on, the air gets circulated resulting in the circulation of the smells. So, find and root out the problem or refresh the room frequently.
	Q	It sends out bad smells.
	A	When the air filter is filthy, it could send out bad smells. So, clean the filter and ventilate the room with the windows open while operating the Ventilation function.
Operation	Q	It won't start.
	A	There is a power failure or it is plugged out. Also, check if the power distribution panel is switched off.
	Q	It goes off during operation.
	A	When the hot air does not escape properly, it goes off during operation. It occurs when it does not ventilate properly because the outdoor unit is covered, the back of the outdoor unit is blocked by a cardboard or a plywood panel, and the front of the outdoor unit is blocked by the closed window or other obstacles. Clear the above obstacles from the outdoor unit.
	Q	It generally works properly. But, when it's considerably hot, it goes off during operation.
A	It occurs when the outdoor unit is exposed to direct sunlight and the hot air does not escape properly. Set up a sun blind over the outdoor unit and clear the neighboring obstacles from the outdoor unit to provide good ventilation. When it goes off frequently during a heat wave, it would prevent the turn-off and increase the cooling capacity cleaning the outdoor unit or spraying some water to the heat exchanger.	
Q	The remote controller won't operate.	
A	When the batteries run out or the transmitter or receiver of the remote controller is blocked by obstacles, change the batteries or keep the obstacles away from the controlling area. Also, the remote controller may not work under intensive light from a 3-wave length lamp or a neon sign due to the EMI. In this case, take the remote controller closer to the receiver.	

Classification	Class	Description
Installation	Q	Who installs the air conditioner? (Relocation/Re-installation)
	A	When relocating or re-installing the air conditioner, make sure to contact Samsung Electronics Service Center or Authorized Service Agent and have them to do the job.(If not, it could cause personal injury or product damage.) The cost for the relocation/re-installation of the air conditioner is subject to the customer's expense. There is a cost table. But, our service engineer needs to visit to total up the cost correctly. When you move in, make sure to contact Samsung Electronics Service Center or Authorized Service Agent in advance to streamline the process.
	Q	Is it possible to install the outdoor unit outside?
	A	It is possible to install it at a designated place in the apartment or on the rooftop nearby. But, it's illegal hanging an angle iron case with the outdoor unit in it outside the apartment. Also, it is illegal obstructing passers-by with the outdoor unit installed outside.
	Q	What can be done to install the outdoor unit facing the road because it is a commercial building?
	A	The following is an excerpt from Building Code going into effect from JUNE 1st 2005. "The exhaust pipe of a cooling or ventilation facility installed in a building adjacent to the streets of commercial or residential areas shall be installed higher than 2m to prevent the exhaust air from blowing directly to passers-by and the current facilities shall be corrected by MAY 31st 2005." So, please install it higher than 2m or not to blow the hot exhausting air directly to passers-by.
	Q	What about installing a windscreen during installation not to blow hot air directly to passers-by?
	A	When the hot air from the front of the outdoor unit is blocked, the product's performance will be affected and it will fail to operate properly. So, keep it at least 300mm away from its surrounding walls and give it good ventilation.

7-12 Common sense of refrigeration

■ Air supplier?

It supplies fresh air to the building or room through procedure of air circulation for fresh environment.

■ Effectiveness of air supplier

It diminishes the stress or fatigue and enhances vivid desire through fresh air circulation. Also, filthy air indoor is being cleaned by Air-Filter and it keeps clean and fresh environment and dehumidification. Temperature, humidity, air stream, cleanness are called for factors of air supplier and they are kept in proper condition for usage purpose.

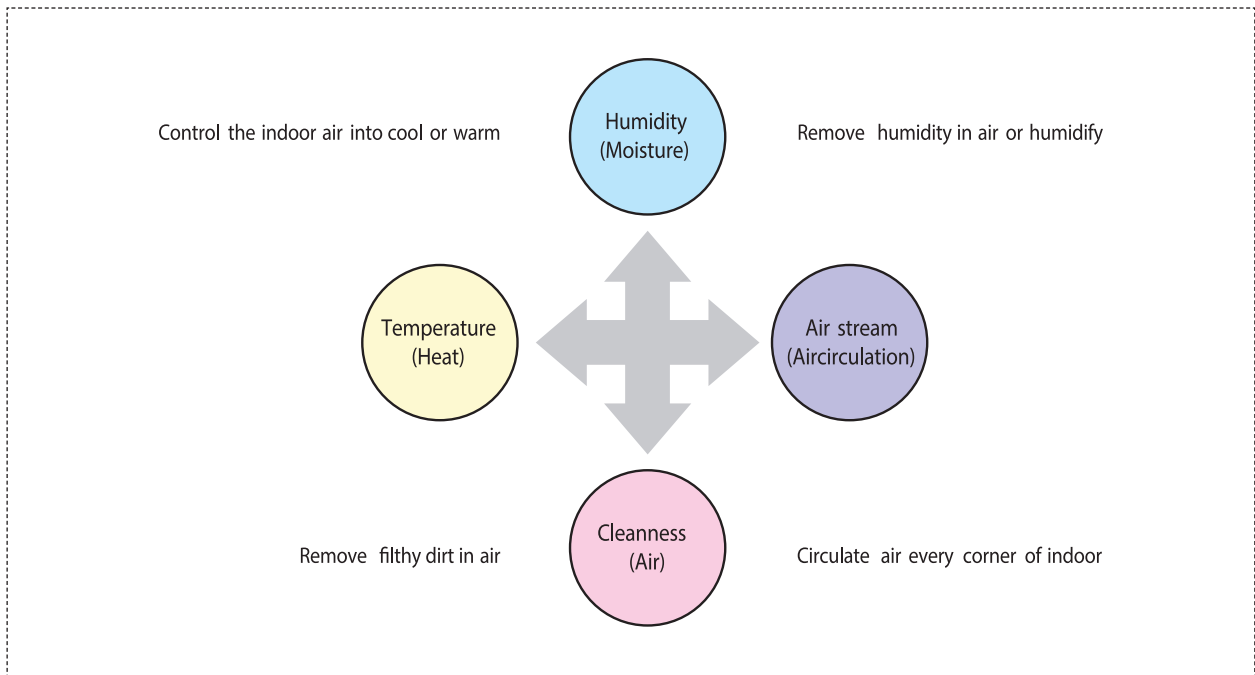

■ Four factors of air suppliers

The human body keeps regular temperature regarding the human body's freshness.

For keeping freshness, heat generated from human body should emit outside of the body by air circulation, conduction, emission, and evaporation. The human body feels freshness when the emission rate is 40~45%, which was emitted by a radiation when it is comfortable and warm, and air circulation and conduction is 20~30%, and evaporation is 20~24%.

It sometimes may depends on seasonal factor, wearing condition, age, sex and mental state other than indoor environment.

But generally the value of fresh indoor temperature is that below 0.2(m/s) of indoor air circulation, the temperature is 21~28°C when the wall temperature is the same as the indoor's and relative humidity is 30~31% in summer, the winter temperature is 20~24°C and relative humidity is 30~60% in winter.



GSPN (GLOBAL SERVICE PARTNER NETWORK)

Area	Web Site
Europe, CIS, Mideast & Africa	gspn1.samsungcsportal.com
Asia	gspn2.samsungcsportal.com
North & Latin America	gspn3.samsungcsportal.com
China	china.samsungportal.com

This Service Manual is a property of Samsung Electronics Co., Ltd.
Any unauthorized use of Manual can be punished under
applicable International and/or domestic law.

© Samsung Electronics Co., Ltd. January. 2020.
Printed in Korea.
Code No. AC-00261E_1